

c-pro 3 CLOSE

Control solutions for close control units



User manual | ENGLISH

Code 144CP3KCE104

**Important**

Read this document thoroughly before installation and before use of the device and follow all recommendations; keep this document with the device for future consultation.

Only use the device in the way described in this document; do not use the same as a safety device.

**Disposal**

The device must be disposed of in compliance with local standards regarding the collection of electric and electronic equipment.

Index

1	INTRODUCTION	8
1.1	Introduction	8
1.2	Summary table of available models, their main characteristics and purchase codes.....	9
2	DESCRIPTION	10
2.1	Description of the main controller (<i>c-pro 3 kilo CLOSE</i>).....	10
2.2	Description of the bipolar stepper electronic expansion valves driver (EVDRIVE03)	11
2.3	Description of the remote user interface (<i>Vgraph O</i>).....	12
2.3.1	Description of the front part	12
2.3.2	Description of the back part	13
3	DIMENSION AND INSTALLATION	14
3.1	Dimension and installation of the main controller (<i>c-pro 3 kilo CLOSE</i>)	14
3.1.1	Dimension of the main controller	14
3.1.2	Installation of the main controller	14
3.2	Dimension and installation of the bipolar stepper electronic expansion valves driver (EVDRIVE03)	15
3.2.1	Dimension of the bipolar stepper electronic expansion valves driver.....	15
3.2.2	Installation of the bipolar stepper electronic expansion valves driver	15
3.3	Dimension and installation of the remote user interface (<i>Vgraph O</i>)	16
3.3.1	Dimension of the remote user interface	16
3.3.2	Installation of the remote user interface	16
3.4	Warnings for the installation.....	17
4	WIRING	18
4.1	I/O CONFIGURATION	18
4.2	Wiring example	21
4.3	Warnings for the electric connection.....	23
5	KEYS AND SIGNALLING	24
5.1	Main controller led signalling	24
5.2	Driver led signalling	24
5.3	User interface keypad.....	25
5.4	User interface led signalling	26
5.5	Local or remote user interface display	26
5.6	Symbols and icons that can be shown on the display.....	27
6	PRIMARY DISPLAY	28
6.1	General information	28
6.2	Main screen	28
6.3	Ventilation	28
6.4	Chilled water.....	28
6.5	Free Cooling.....	28
6.6	Hybrid units with primary water circuit	29
6.7	Direct expansion.....	29
6.8	Condenser regulation	29
6.9	Hybrid units with secondary water circuit.....	29
6.10	Heating	29
6.11	Humidification	30
6.12	Dry Cooler	30
7	MAIN MENU	30
7.1	General information	30
7.2	Set - Set-point.....	30
7.3	Network-CANBUS local network status.....	30
7.4	PAR - Regulation parameter.....	30
7.5	RTC - Clock.....	30
7.6	ALM - Active alarms.....	30
7.7	LOG - Alarms log.....	30

7.8	ORE – Operating hours	31
7.9	INFO - Information	31
8	UNIT USE	31
8.1	Language of the control software	31
8.2	Key lock	31
8.3	Unit switch-on	31
8.3.1	OFF via remote and via supervisory/BMS MODBUS SYSTEM	31
8.3.2	Automatic RE-START due to power failure	32
8.3.3	Power supply failure alarm	32
8.4	Motorised shutters control.....	32
8.5	Air supply fans regulation	32
8.5.1	Fixed speed variable fans control	32
8.5.2	Regulation of modulating fans proportionally to the cooling or heating request	33
8.5.3	Adjustment of constant air flow variable speed fans	33
8.5.4	Constant pressure variable fans control	34
8.5.5	Starting speed control	34
8.5.6	Fan alarm management	34
8.5.7	Air differential pressure sensor alarm	35
8.6	Temperature regulation	35
8.6.1	Temperature control type	35
8.6.2	Setting the temperature set-point limits	35
8.6.3	Temperature regulation neutral zone setting	35
8.6.4	Proportional temperature regulation	36
8.6.5	Proportional + integral temperature regulation	36
8.6.6	Proportional + integral + derivative temperature regulation	37
8.6.7	High or low temperature alarm	38
8.6.8	Air temperature probes alarm management	38
8.7	Limit temperature regulation	39
8.7.1	Limit temperature.....	39
8.7.2	High and low limit temperature management	39
8.8	Humidity regulation.....	40
8.8.1	Humidity probe configuration	40
8.8.2	Setting humidity set-point limits	40
8.8.3	Humidity regulation neutral zone setting.....	40
8.8.4	Humidity proportional regulation.....	40
8.8.5	Partial dehumidification	41
8.8.6	Dehumidification lock	41
8.8.7	Humidifier presence setting.....	41
8.8.8	Humidification production percentage.....	41
8.8.9	Steam production during cooling.....	41
8.8.10	Humidification proportional regulation	41
8.8.11	Manual humidifier water drain	42
8.8.12	Lines and humidifier cylinder pre-washing management	42
8.8.13	High and low humidity alarms	42
8.8.14	Air humidity probes alarm management	43
8.8.15	Humidifier alarm management	43
8.9	Direct expansion unit regulation	43
8.9.1	General information	43
8.9.2	Management of ON-OFF compressor	43
8.9.3	ON-OFF compressor automatic rotation	43
8.9.4	Compressor management with inverter regulation	44
8.9.5	Superheating regulation with electronic expansion valve (only if present)	44
8.9.6	Condensation pressure and temperature detection.....	44
8.9.7	De-superheating management (aggiungere i parametri relativi alla funzione)	45
8.9.8	Control of early valve opening upon compressor start-up.....	45
8.9.9	Low Superheat (LoSH) management	45
8.9.10	High superheat (HiSH) management	45

8.9.11	High compressor evaporation pressure management (MOP)	45
8.9.12	Low compressor evaporation pressure management (LOP).....	45
8.9.13	Low evaporation pressure alarm	45
8.9.14	Management of high compressor discharge temperature.....	46
8.9.15	Failed compression compressor alarm	46
8.9.16	High condensation pressure alarm	46
8.9.17	Compressor thermal magnetic protection alarm	46
8.9.18	Electronic valve alarm management (if present)	46
8.10	Condenser regulation	47
8.10.1	General information	47
8.10.2	Condensers proportional regulation	47
8.10.3	Condenser regulation with AUTASET-POINT	47
8.10.4	Start-up request management.....	48
8.10.5	Condenser regulation management with broken probe	48
8.10.6	Condenser alarm management	48
8.11	Evaporating unit regulation for connection to remote condensing unit	48
8.11.1	General information	48
8.11.2	Configuration for operation with remote condensing unit	48
8.11.3	Condensing unit alarm management	48
8.12	Chilled water units regulation	49
8.12.1	General information	49
8.12.2	Chilled water circuit management	49
8.12.3	Water circuit temperature detection	49
8.12.4	WATER TEMPERATURE PROBES ALARMS MANAGEMENT	49
8.13	Free cooling unit control	49
8.13.1	General information	49
8.13.2	Free cooling system control.....	49
8.13.3	Forzatura sistema free cooling.....	50
8.13.4	Free cooling temperature probe alarm management.....	50
8.14	Dry cooler regulation.....	50
8.14.1	General information	50
8.14.2	Dry cooler proportional regulation	50
8.14.3	Dry cooler regulation with autaset-point	51
8.14.4	Start-up request management.....	51
8.14.5	Dry cooler fans cut-off regulation.....	51
8.14.6	Dry cooler regulation management with broken water temperature probe.....	51
8.14.7	Dry cooler alarms management	52
8.15	Water pump management.....	52
8.15.1	General information	52
8.15.2	Water pump management configuration	52
8.15.3	Water pump switch off delay management.....	52
8.15.4	Water pump alarm management.....	52
8.16	Hybrid units regulation	52
8.16.1	General information	52
8.16.2	Water hybrid system regulation	52
8.16.3	Direct expansion hybrid system regulation	53
8.16.4	Secondary cooling source overriding	53
8.17	Heating components regulaiton	53
8.17.1	General information	53
8.17.2	Heating with stage electric heaters.....	53
8.17.3	Heating with electrical or water modulating coils.....	54
8.17.4	Electric heater alarms management	54
8.18	Configurable digital inputs.....	55
8.18.1	General information	55
8.18.2	Configurable digital inputs management	55
8.19	Configurable digital outputs	56
8.19.1	General information	56

8.19.2	Configurable digital outputs management	56
8.20	Internal components alarms management	57
8.20.1	Air filter alarm management.....	57
8.20.2	Water presence/ condensate drain pump alarm management.....	57
8.20.3	Smoke/fire alarm management	57
8.20.4	Non critical and critical generic alarm management.....	57
8.21	Probe calibration management	57
8.22	MODBUS RTU slave serial communication management.....	57
8.23	Changing access passwords	58
8.24	Clearing the alarm log and operating hours	58
8.24.1	Clearing the alarm log	58
8.24.2	Clearing operating hours.....	58
9	COMPONENT CONTROL MODBUS MASTER NETWORK	59
9.1	General information	59
9.2	MODBUS master network device routing.....	59
9.2.1	Fans self-routing in case of replacement.....	59
10	UNIT CONTROL CANBUS NETWORK.....	60
10.1	General information	60
10.2	Addressing unit in the local network.....	60
10.3	Local network types	61
10.4	Local network regulation.....	61
10.4.1	General information	61
10.4.2	AUTOMATIC UNIT ROTATION	61
10.4.3	Stand-by unit activation in case of alarm	61
10.4.4	Management of the temperature regulation support system	61
10.5	Switching on system with dynamic On/Off	62
10.5.1	General information	62
10.5.2	Unit network entry.....	62
10.6	Dynamic set-point system.....	62
10.7	Air temperature, humidity and pressure average control system.....	62
10.7.1	Exclusion from average calculation.....	62
10.8	Failed local network communication alarm management.....	62
11	CONTROL SOFTWARE PARAMETERS AND THEIR MODIFICATION.....	63
11.1	Access to password protected menus	63
11.1.1	Login password entry	63
11.2	ACCESS TO REGULATION PARAMETER MENUS.....	63
11.3	Modifying the control parameters.....	63
11.4	Exiting the groups, menus and main menu	63
12	CONFIGURATION PARAMETERS LIST.....	64
12.1	Set-point Menu: set-point modification	64
12.2	User setup: setting the operating program.....	64
12.3	Manufacturer setup loop: configuration of the components.....	66
12.4	Advanced loop setup: components configuration.....	75
13	UNIT ALARMS MANAGEMENT.....	84
13.1	Signalling, check and clearance of alarm conditions.....	84
13.1.1	Alarm presence signalling	84
13.1.2	Alarm condition check	84
13.1.3	Resetting an alarm.....	84
14	DESCRIPTION OF UNIT'S ALARMS.....	84
15	SUPERVISION THROUGH MODBUS RTU SLAVE PROTOCOL.....	92
16	SURVEY DEVICE TROUBLESHOOTING.....	93
16.1	The unit does not start	93
16.2	Incorrect reading of input signals.....	93
16.3	Questionable alarm signalling from digital input.....	93
16.4	Failed closure of a digital output	93
16.5	Absence of analogue outputs.....	93
16.6	The c-pro 3 kilo CLOSE activates the watch-dog function	93

16.7	Serial connection with the supervisor/bms does not work	93
16.8	Local network connection does not work	94
16.9	MODBUS master connection does not work	94
17	ACCESSORIES	95
17.1	RS-485/USB EVIF20SUXI Serial interface	95
17.1.1	General information	95
17.2	EVUSB4096M 4 GB USB flash drive	95
17.2.1	General information	95
17.3	EVKEY10 Programming key	95
17.3.1	General information	95
17.4	0026700005 Frontal plate	96
17.4.1	General information	96
17.5	Gasket 0027000018 (Descrizione della guarnizione con codice 0027000007)	96
17.5.1	General information	96
17.6	Double-sided tape 0043600013	96
17.6.1	General information	96
17.7	Backup module	96
17.7.1	General information	96
17.8	CJAV18 and CJAV20 connecting kit	97
17.8.1	General information	97
17.9	CJAV23 connecting kit	97
17.9.1	General information	97
17.10	CJAV25 connecting kit	97
17.10.1	General information	97

1 INTRODUCTION

1.1 Introduction

c-pro 3 CLOSE is a control solution for the management of direct expansion close control units (with one circuit or two circuits with one compressor for each circuit) or chilled water close control units.

It consists of:

- a main controller (c-pro 3 kilo CLOSE, available in blind version)
- a bipolar stepper electronic expansion valves driver for each circuit (EVDRIVE03, available with integrated user interface or in blind version)
- a remote user interface (**Vgraph O**).

The solution is able to manage both "on-off" and variable speed compressors; it is also able to manage both "on-off" and modulating fans.

It has the secondary source, the dry cooler and the "free cooling" management.

Installation of the main controller is on DIN rail, into a control panel.

1.2 Summary table of available models, their main characteristics and purchase codes

The following table contains a description of the available models, the main characteristics of the devices and the purchase codes.

	available models >	EVDRIVE03		<i>Vgraph O</i>	
	purchase codes >	EPK3BXP1CC	EPD4BC3	EPD4DF3	EPV4LBO
Version					
blind		•	•		
built-in LCD (128 x 64 pixel single colour LCD graphic display)				•	•
Connection					
removable spring terminal blocks		•			
removable screw terminal blocks		•	•	•	•
Power supply					
24 VAC/VDC not isolated		•	•	•	•
Communication ports					
TTL for programming			•	•	•
RS-485 MODBUS master		•			
RS-485 MODBUS slave		•	•	•	
CAN CANBUS		•	•	•	•
USB		•			
Other characteristics					
clock		•			
alarm buzzer					•

For additional models, contact the EVCO distribution network.

2 DESCRIPTION

2.1 Description of the main controller (c-pro 3 kilo CLOSE)

The following drawing shows the layout of the main controller.

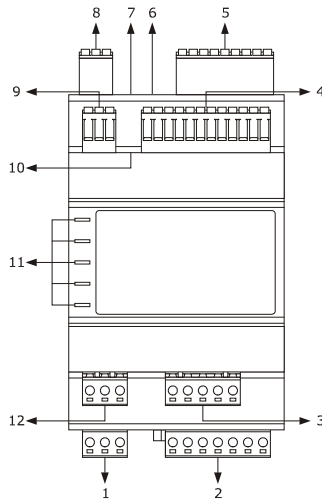

The following table describes the meaning of the main controller parts.

PART	MEANING
1	K6 and K7 digital outputs
2	K1... K5 digital outputs
3	K9 digital outputs
4	7... 9 analogue inputs, 6... 9 digital inputs and 4... 6 analogue outputs
5	1... 6 analogue inputs, 1... 5 digital inputs and 1... 3 analogue outputs
6	USB port
7	micro switch for RS-485 MODBUS slave port and CAN CANBUS port line termination
8	power supply, RS-485 MODBUS slave port and CAN CANBUS port
9	RS-485 MODBUS master port
10	micro switch for RS-485 MODBUS master port line termination
11	LED signals
12	K8 digital output

For additional information, please refer to the following chapters.

2.2 Description of the bipolar stepper electronic expansion valves driver (EVDRIVE03)

The following drawing shows the layout of the bipolar stepper electronic expansion valves driver.

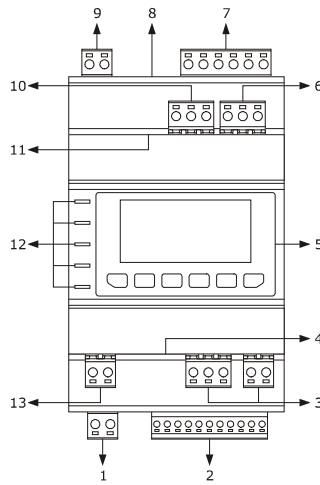

The following table describes the meaning of the driver parts:

PART	MEANING
1	K1 digital output
2	Analogue inputs and free of voltage digital inputs
3	CAN CANBUS port
4	micro switch for CAN CANBUS port line termination
5	Display and keyboard (not available in the blind version)
6	reserved
7	Bipolar stepper engine output
8	TTL MODBUS port
9	power supply
10	RS-485 MODBUS slave port
11	micro switch for RS-485 MODBUS slave port line termination
12	LED signals
13	230 VAC digital input

For additional information, please refer to the following chapters.

2.3 Description of the remote user interface (*Vgraph O*)

2.3.1 Description of the front part

The following drawing shows the layout of the remote user interface front.

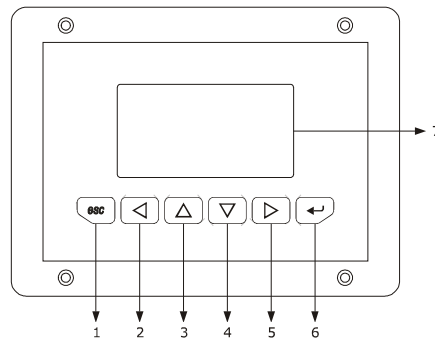

The following table describes the meaning of the device front parts.

PART	MEANING
1	"ESCAPE" key
2	"LEFT" key
3	"UP" key
4	"DOWN" key
5	"RIGHT" key
6	"ENTER" key
7	display

For additional information, please refer to the following chapters.

2.3.2 Description of the back part

The following drawing shows the layout of the remote user interface back part.

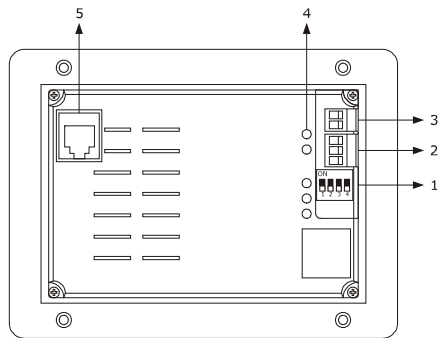

The following table describes the meaning of the device back parts.

PARTE	SIGNIFICATO
1	micro switch for CAN CANBUS port line termination
2	CAN CANBUS port
3	power supply
4	LED signals
5	TTL port

For additional information, please refer to the following chapters.

3 DIMENSION AND INSTALLATION

3.1 Dimension and installation of the main controller (*c-pro 3 kilo CLOSE*)

3.1.1 Dimension of the main controller

The following drawing shows the measurements of the main controller (4 DIN modules), in mm (in).

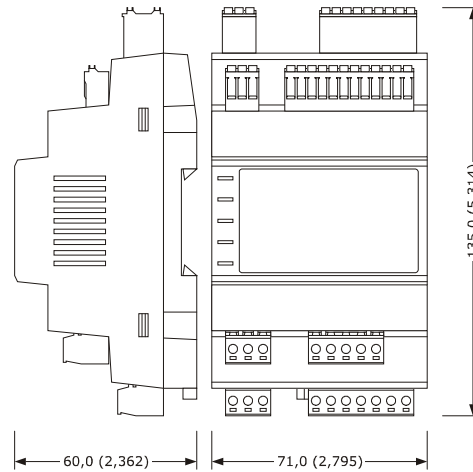

3.1.2 Installation of the main controller

The device is designed to be mounted on 35,0 x 7,5 mm (1,377 x 0,295 in) or 35,0 x 15,0 mm (1,377 x 0,590 in) DIN rail, into a control panel.

To mount the device, proceed as indicated in the following drawing.

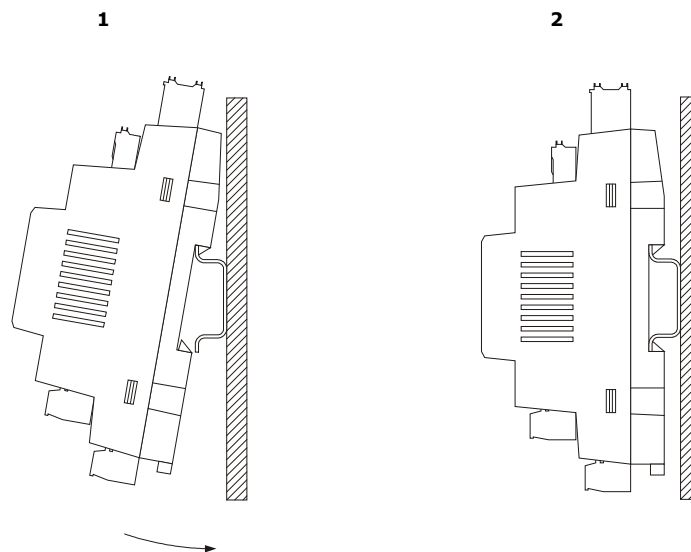

To dismantle the device, first remove the removable screw terminal blocks connected at the bottom, then use a screwdriver to pull away the clip from the DIN rail, as shown in the following drawing.

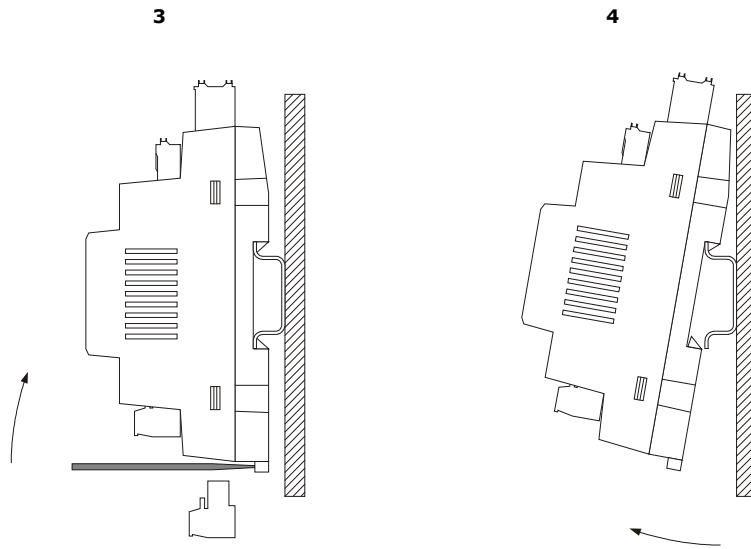

To install back the main controller, first pull down the clip from the DIN rail.

3.2 Dimension and installation of the bipolar stepper electronic expansion valves driver (EVDRIVE03)

3.2.1 Dimension of the bipolar stepper electronic expansion valves driver

The following drawing shows the measurements of the bipolar stepper electronic expansion valves driver (4 DIN modules), in mm (in).

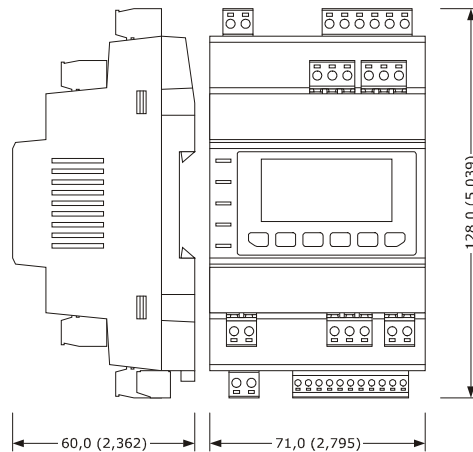

3.2.2 Installation of the bipolar stepper electronic expansion valves driver

Operate as indicated for the main controller.

3.3 Dimension and installation of the remote user interface (Vgraph O)

3.3.1 Dimension of the remote user interface

The following drawing shows the measurements of the remote user interface, in mm (in).

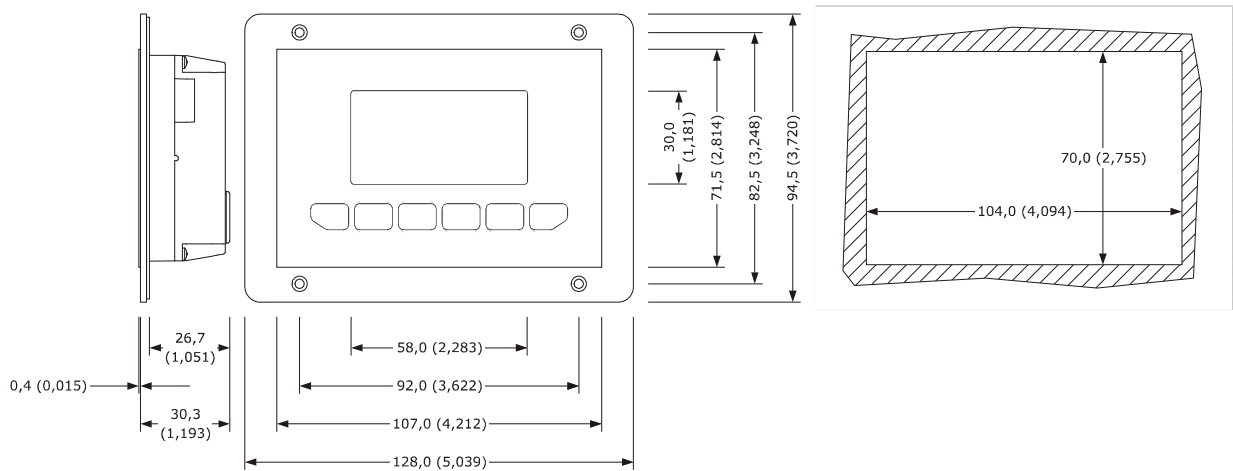

3.3.2 Installation of the remote user interface

Installation is by front or by back-panel.

The following drawing shows how to install a remote user interface on the front panel, with 0027000018 gasket and 0026700005 frontal plate (included).

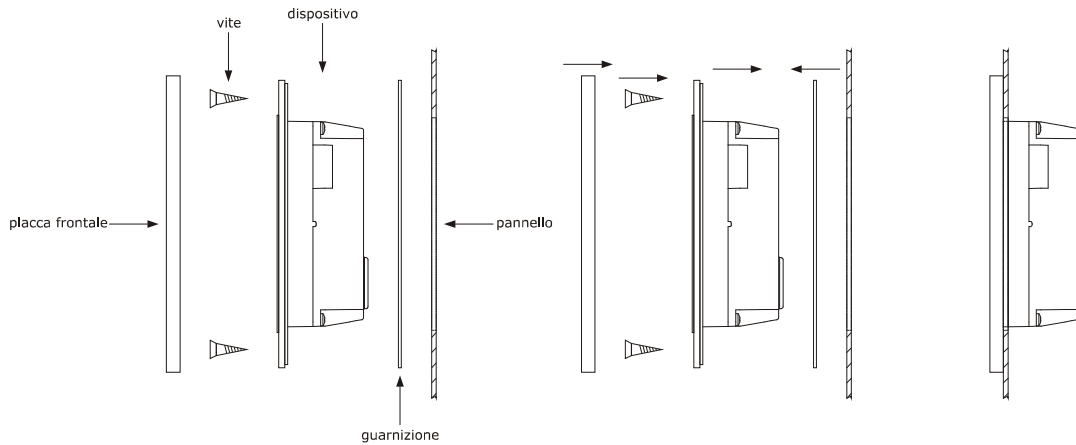

The following drawing shows how to install a remote user interface on the back panel, threaded studs and 0043600013 overlay (the latter is included).

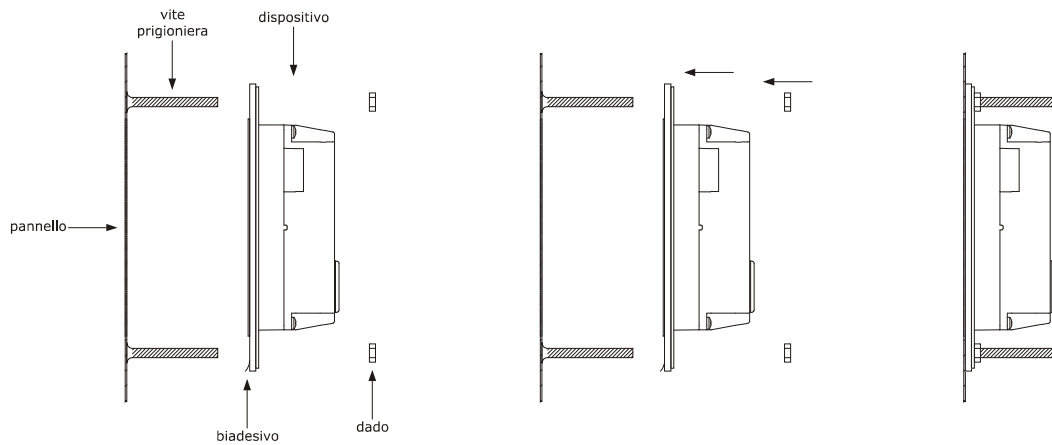

3.4 Warnings for the installation

- make sure that the device work conditions (temperature of use, humidity, etc.) lie within the limits indicated; see chapter "TECHNICAL DATA"
- do not install the device near to any heat sources (heating elements, hot air ducts etc.), equipment containing powerful magnets (large diffusers, etc.), areas affected by direct sunlight, rain, humidity, excessive dust, mechanical vibrations or shocks
- in compliance with Safety Standards, the device must be installed correctly and in a way to protect against any contact with electric parts; all parts that ensure protection must be fixed in a way that they cannot be removed without the use of tools.

4 WIRING

4.1 I/O CONFIGURATION

The following chart shows an example of ready for use configuration for direct expansion bicircuit close control units or chilled water close control units, with a bipolar stepper electronic expansion valves driver for each circuit (EVDRIVE03) and modulating fans; it is possible to customize the I/O configuration.

		<i>c-pro 3 kilo CLOSE</i>	EVDRIVE03 circuit 1	EVDRIVE03 circuit 2
Analogue inputs				
AI1	return air pressure	•		
AI2	return air humidity	•		
AI3	return air temperature	•		
AI4	supply air humidity	•		
AI5	return air temperature	•		
AI6	circuit 1 discharge temperature	•		
AI7	circuit 1 condensation pressure	•		
AI8	circuit 2 discharge temperature	•		
AI9	circuit 2 condensation pressure	•		
AI1	circuit 1 discharge temperature		•	
AI2	circuit 1 condensation pressure		•	
AI3	circuit 1 suction temperature		•	
AI4	circuit 1 evaporation temperature		•	
AI1	circuit 2 discharge temperature			•
AI2	circuit 2 condensation pressure			•
AI3	circuit 2 suction temperature			•
AI4	circuit 2 evaporation pressure			•
Digital inputs				
DI1	shutter limit switch	•		
DI2	dirty filter sensor	•		

DI3	switch-off	•		
DI4	flooding sensor	•		
DI5	configurable	•		
DI6	configurable	•		
DI7	configurable	•		
DI8	configurable	•		
DI9	configurable	•		
DI1	circuit 1 compressor thermal protection		•	
DI2	circuit 1 high pressure switch		•	
DI3	circuit 1 low pressure switch		•	
DI1	circuit 2 compressor thermal protection			•
DI2	circuit 2 high pressure switch			•
DI3	circuit 2 low pressure switch			•

Analogue outputs

AO1	supply fan	•		
AO2	cooling coil mixing valve/FC/Inverter	•		
AO3	heating coil (water) mixing valve/Modulating heater	•		
AO4	hybrid units chilled water mixing valve	•		
AO5	dry cooler/condenser 1	•		
AO6	humidifier/condenser 2	•		

Digital outputs

DO1	enables supply fan	•		
DO2	shutter	•		
DO3	heating coil (electric) stage 1	•		
DO4	heating coil (electric) stage 2	•		

D05	configurable	X		
D06	configurable	•		
D07	configurable	•		
D08	configurable	•		
D09	configurable	•		
D01	circuit 1 compressor		•	
D01	circuit 2 compressor			•

For additional information, please refer to the following chapters.

4.2 Wiring example

The following drawing shows an example of wiring diagram for direct expansion of bicircuit close control units or refrigerated water close control units, with a bipolar stepper electronic expansion valves driver for each circuit (EVDRIVE03) and modulating fans.

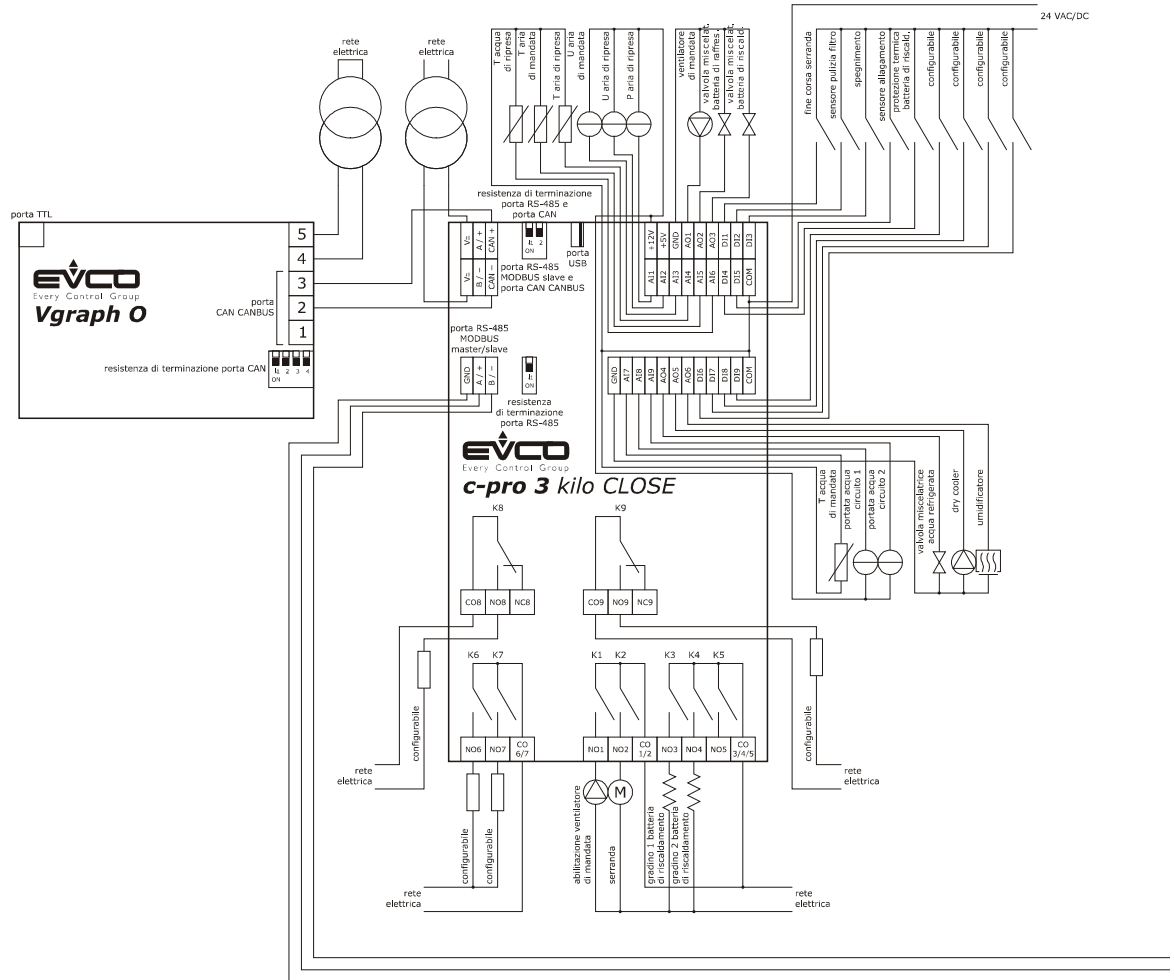

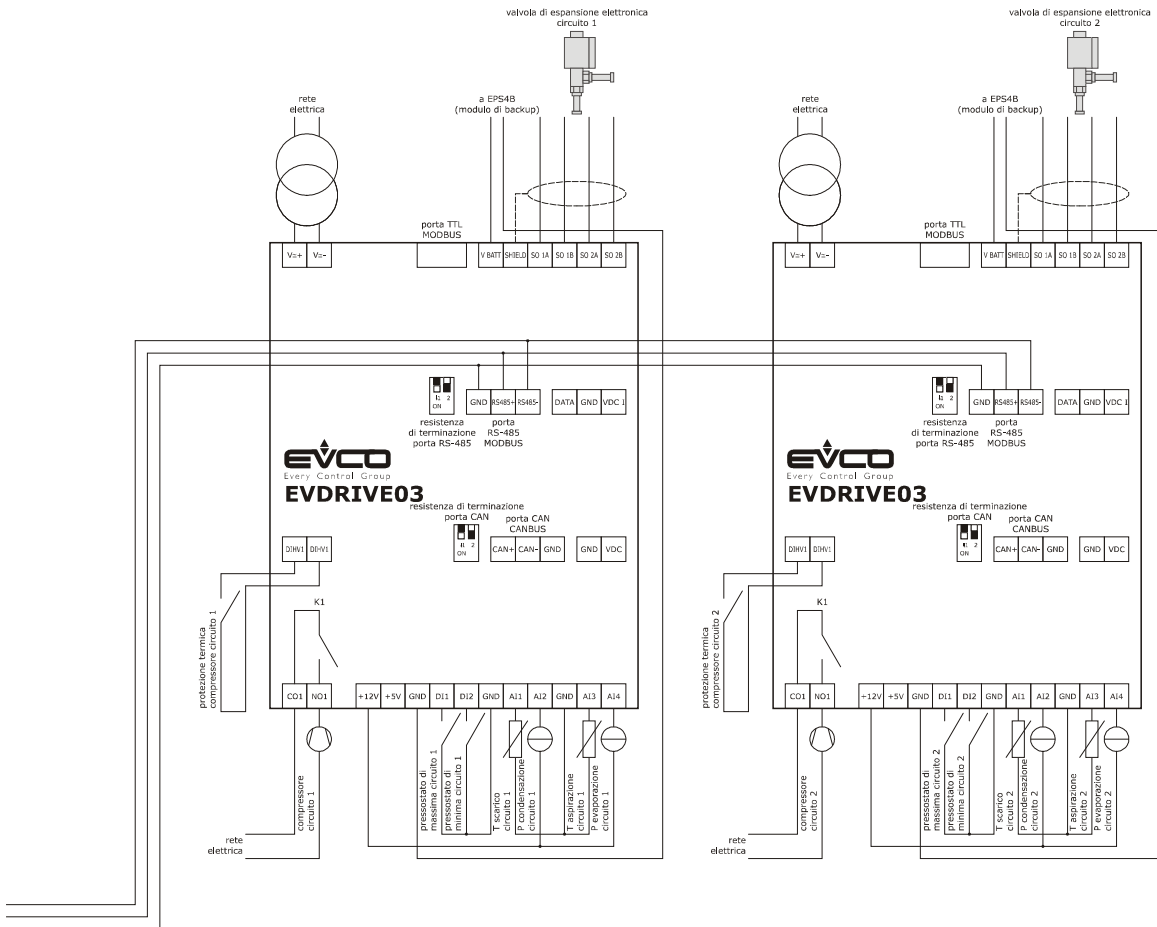

4.3 Warnings for the electric connection

- do not use electric or pneumatic screwdrivers on the device terminal board
- if the device has been taken from a cold to hot place, humidity could condense inside; wait about 1 hour before powering it
- make sure that the power supply voltage, the frequency and the operational electric power of the device, correspond with those of the local power supply; see chapter "TECHNICAL DATA"
- disconnect the device power supply before proceeding with any type of maintenance
- connect the device to a RS-485 MODBUS network using a twisted pair
- connect the device to a CAN network using a twisted pair
- position the power cables as far away as possible from the signal cables
- do not use the device as a safety device
- for repairs and information regarding the device, contact the EVCO sales network.

5 KEYS AND SIGNALLING

5.1 Main controller led signalling

The main controller has LEDs with specific functions, as indicated in the following table.

LED SIGNALLING		
NAME	COLOR	DESCRIPTION
ON	Green	Power supply LED: <ul style="list-style-type: none"> Light is on if the device is powered Light is off if the device is not powered
RUN	Green	Operation LED: <ul style="list-style-type: none"> Light is on if the application software is running Light is off if the application software is not running
	Red	System alarm LED: <ul style="list-style-type: none"> Light is on if a system alarm resettable via application software is occurring Light blinks very slowly if an access in the external flash memory is occurring Light blinks slowly if an automatically resettable system alarm is occurring Light blinks quickly if a manually resettable system alarm is occurring Light is off if no system alarm is occurring
CAN	Red	CANbus communication LED: <ul style="list-style-type: none"> Light is on if the CANbus communication has not been established Light blinks slowly if the CANbus communication is affected by errors Light blinks quickly if the CANbus communication is correctly established Light is off if no CANbus communication is established
L1	-	Not used

5.2 Driver led signalling





The driver has LEDs with specific functions, as indicated in the following table.



LED SIGNALLING		
NAME	COLOR	DESCRIPTION
ON	Green	Power supply LED: <ul style="list-style-type: none"> Light is on if the device is powered Light is off if the device is not powered
STEP 1	Green	Stepper motor output LED: <ul style="list-style-type: none"> Light is on if the valve closes completely Light blinks slowly if the valve opens completely Light blinks quickly if the valve is moving Light is off if the valve is not moving

LED SIGNALLING		
NAME	COLOR	DESCRIPTION
STEP 2	Green	Operation LED: <ul style="list-style-type: none"> Light is on if superheating control is running Light is off if superheating control is running
	Red	Alarm LED: <ul style="list-style-type: none"> Light is on if an alarm is occurring If light blinks slowly, device operation must be disabled/enabled to allow the configuration change to become effective If light blinks slowly, device power supply must be turned off/on to allow the configuration change to become effective Light is off if no alarm is occurring
COM	Green	Communication LED: <ul style="list-style-type: none"> Light is on if communication is in alarm mode and the device is locked Light blinks slowly if communication is affected by errors Light blinks quickly if communication is in alarm mode and the device operates in stand-alone mode Light is off if communication is correct

5.3 User interface keypad



The user interface has KEYS with specific functions, as indicated in the following table.

KEY	NAME	DESCRIPTION
	ESC	If pressed, it enables exit from the menus and parameter editing.
	ON-OFF	If pressed and held, it turns the unit on and off.
	LEFT	Press it to scroll the unit's status pages to the left.
	ALARM	If pressed and held, it enables access to the active alarms menu.
	UP	Press it to scroll up through the pages associated with a specific group; if the cursor is in a setting field, it enables the user to increase the value.
	DOWN	Press it to scroll down through the pages associated with a specific group; if the cursor is in a setting field, it enables the user to decrease the value.
	RIGHT	Press it to scroll the unit's status pages to the right.
	HOME	Press and hold it to go back to the Home page.

	ENTER	Press it to edit a parameter and confirm the setting. In the active alarms menu, press it to scroll through the alarms, press it and hold it to delete active alarms.
	MENU	If pressed and held, it enables access to the Main menu page.
	UP + DOWN	If pressed and held, it enables to unlock the user terminal.

5.4 User interface led signalling

The user interface has LEDs with specific functions, as indicated in the following table.

KEY	NAME	DESCRIPTION
	Green	<p>Operation LED:</p> <ul style="list-style-type: none"> Light is on if the unit is ON Light blinks if the unit is turned off remotely or due to a critical alarm or if the unit is in Stand-by (Local Network) Light is off if the unit is OFF
	Red	<p>Alarm LED:</p> <ul style="list-style-type: none"> Light is on if an alarm is occurring and it has already been viewed Light blinks if a new alarm is occurring Light is off if no alarm is occurring
	Orange	<p>Power supply LED:</p> <ul style="list-style-type: none"> Light is on if the device is powered Light is off if the device is not powered

5.5 Local or remote user interface display



















The user terminal is fitted with a graphic LCD single-colour display (black with white LED back lighting) of 128 x 64 pixel, to view information on the units' control software.

The information on unit control is arranged according to the following order:

- MAIN BRANCH:** It enables to rapidly access the units' general status. It displays the status of all components installed in the unit, or controlled by it.
- MAIN MENU:** It enables to access the software management MENUS. The MENUS organize the parameters into categories for easier user interaction.
- MENU:** The main menu contains various MENUS divided as follows. Each MENU contains PARAMETERS GROUPS which can be viewed or edited.
 - OPEN MENU:** they display alarms, device operating hours, time and date; they enable the entry of temperature and humidity setpoints and the adjustment of the internal clock.
 - PASSWORD PROTECTED MENUS:** they enable the setting of the unit's regulation and configuration parameters.
- GROUPS OF PARAMETERS:** The PARAMETERS are collected in specific GROUPS, making it easier to access and edit them.



5.6 Symbols and icons that can be shown on the display

Various types of icons are used in the software pages. The meaning of the icons is laid out in the table below.

Software Icons			
			
Dampers opening	Fans ON	Cooling mode ON	Modulating compressor ON
			
Compressor 1 ON	Compressor 2 ON	2 compressors ON	Heating mode ON
			
Modulating heater ON	Modulating heater stage 1 ON	Modulating heater stage 2 ON	Modulating heater stage 1+2 ON
			
Humidifier ON	De-humidifier ON	Free cooling ON	Hybrid units primary source ON
			
Hybrid units secondary source ON	Alarm ON	Keylock ON	

6 PRIMARY DISPLAY

6.1 General information

This group of pages represents the control software primary display. The pages may be accessed simply by pressing the **LEFT** () and **RIGHT** () keys. The parameters concerning the non-installed components will not be displayed, it is therefore possible that some pages cannot be displayed.

6.2 Main screen

This page represents the primary software display. The following can be displayed within this page:

- The set time and date.
- The return temperature (if present).
- The supply temperature (if present).
- The humidity (if present).
- The status of the unit.
- The presence of an active alarm.
- The icons of the main active components (see previous chapter).

6.3 Ventilation

The ventilation status pages show different views depending on which type of regulation has been set.

If fixed speed regulation is active, the status of each fan in the unit will be displayed:

- The fan's speed in percentage.
- Number of active fans

If a regulation in proportion to cooling or heating control is active, the following will be displayed in addition to the status of each fan in the unit:

- The controlled temperature.
- The controlled humidity (if humidity control is present).
- The fan's speed in percentage.
- Number of active fans.

If constant air flow regulation is active, the following will be displayed in addition to the status of each fan in the unit:

- The current air flow rate in m³/h.
- The fan's speed in percentage.
- Number of active fans.

If constant air pressure regulation is active, the following will be displayed in addition to the status of each fan in the unit:

- The current air pressure in m³/h
- The fan's speed in percentage.
- Number of active fans.

6.4 Chilled water

The chilled water regulation status pages may show different views depending on the type of accessories the unit is fitted with. It will therefore be possible to view:

- The controlled temperature.
- The controlled humidity (if humidity control is present).
- The inlet water temperature reading (if present).

6.5 Free Cooling

In free cooling units a free cooling circuit status page will be displayed and, after that, the direct expansion circuit pages (see following chapters). The free cooling page will display:

- The controlled temperature.
- The controlled humidity (if humidity control is present).
- The free cooling temperature.
- The free cooling percentage.

6.6 Hybrid units with primary water circuit

In hybrid units with primary water circuit, a primary circuit status page will be displayed and, after that, the secondary direct expansion or water circuit pages (see following chapters). The primary water circuit page will display:

- The controlled temperature.
- The controlled humidity (if humidity control is present).
- The inlet water temperature.
- The cooling request.
- The dehumidification request (if humidity control is present).
- The primary circuit water valve opening percentage.

6.7 Direct expansion

The direct expansion regulation status pages may show different views depending on the type of accessories and number of cooling circuits the unit is fitted with. It will therefore be possible to view:

- The controlled temperature.
- The controlled humidity (if humidity control is present).
- The cooling request.
- Activation status of the compressors.
- The compressor's speed in percentage.

Cooling circuit operating parameters (low pressure):

- The current evaporation pressure.
- The current evaporation temperature.
- Compressor suction temperature.
- Current superheating.

Cooling circuit operating parameters (high pressure):

- Compressor discharge temperature.
- The current condensation pressure.
- The current condensation temperature.

Expansion valve operating parameters:

- Current superheating.
- The opening of the valve in percentage.
- Valve regulation status.

6.8 Condenser regulation

In the condenser regulation pages the following information may be viewed for each condenser:

- The current condensation temperature.

6.9 Hybrid units with secondary water circuit

In hybrid units with secondary water circuit, the following information will be displayed:

- The controlled temperature and relevant set-point.
- The controlled humidity and relevant set-point (if humidity control is present).
- The secondary circuit water valve opening percentage.

6.10 Heating

The heating status pages may show different views depending on the type of accessories the unit is fitted with.

Unit with modulating water valve:

- The controlled temperature.
- The controlled humidity (if humidity control is present).
- The heating circuit water valve opening percentage.

Unit with modulating electric coil:

- The controlled temperature.
- The controlled humidity (if humidity control is present).
- The heating electric coil regulation percentage.

Unit with electric stage heater:

- The controlled temperature.
- The controlled humidity (if humidity control is present).

- Number of active stages.

6.11 Humidification

In units with humidification system, the following information will be displayed:

- The controlled humidity.
- The humidifier operation percentage.

6.12 Dry Cooler



In units with dry cooler control system, the following information will be displayed:

- The unit's inlet water temperature.
- The dry cooler regulation percentage.

7 MAIN MENU

7.1 General information

To access the MENU, simply press and hold the ENTER key ().

It is possible to select the MENUS on the MAIN MENU by moving the cursor with the UP () and DOWN ().

Press the ENTER () key to access the menu selected.

7.2 Set – Set-point

Within the SET (Set-point) menu, it is possible to modify the ambient temperature and ambient humidity regulation setpoints.

These parameters can be modified so that the user is able to select his/her preferred environmental conditions.

7.3 Network–CANBUS local network status

The general status of all units of the local network may be viewed within the NETWORK (Local network status) menu. The unit you are accessing from will be displayed with an L (Local) while the other units will be displayed with their network address (from 1 to 12).

The units may have the following statuses:

- --- : Unit not on the network.
- OFF: Unit off.
- ON: Unit on.
- STB: Unit in stand-by.
- ALM: Unit in alarm.
- OFL: Unit off-line.

7.4 PAR – Regulation parameter

Within the PAR (Parameters) menu, after gaining access by entering the correct login password, it is possible to edit the unit regulation parameters and the unit configuration parameters. The group is divided into the following sections:

- **USER SETUP:** Modification of the unit control and operation parameters.
- **MANUFACTURER SETUP:** Configuration of unit operational parameters.
- **LANGUAGE:** Enables the software language to be changed.
- **DELETE LOGGING:** Can be used to delete the working hours count and the alarms log.

7.5 RTC - Clock

Within the **RTC (Clock)** menu, it is possible to change the current time and date.

7.6 ALM – Active alarms

With the **ALM (Active alarms)** menu it is possible to display the active alarms on the unit. Access to this menu is gained by pressing and holding the **ALARM** key ()

7.7 LOG – Alarms log

Within the **LOG (Alarms log)** menu it is possible to display the log of the unit's alarms. The alarms will be stored in chronological order. The page will display trigger date, trigger time and duration of the alarm. Press the ENTER (), to scroll alarms stored.

7.8 ORE – Operating hours

Within the **HOURS (Operating hours)** menu it is possible to display the operating hours of the following unit components:

- **Unit hours of operation:** Indicate total unit operating hours (Unit ON).
- **Compressor 1:** Indicate total operating hours of compressor 1.
- **Compressor 2:** Indicate total operating hours of compressor 2.
- **Water Valve:** Indicate total operating hours of the chilled water valve.
- **Electric heaters:** Indicate total operating hours of the electric coil.
- **Humidifier:** Indicate total operating hours of the humidifier.
- **Free Cooling:** Indicate total operating hours of the free cooling system.
- **Dry cooler:** Indicate total dry cooler operating hours.
- **Condenser 1:** Indicate total operating hours of condenser 1.
- **Condenser 2:** Indicate total operating hours of condenser 2.

7.9 INFO - Information

Within the **INFO (Information)** menu it is possible to display the unit's serial number and software version installed on the unit.

8 UNIT USE

8.1 Language of the control software

The regulation software lets you configure several languages. With the "Language" parameter (Language Menu) it is possible to select one of the following languages:

- 1) **Italian**
- 2) **English**



8.2 Key lock

The regulation software lets you configure a key lock function, which is automatically activated if the keypad is not touched for 120 s.

With the "Enable Key Lock" parameter (Manufacturer Setup - Key lock configuration) it is possible to select one of the following types of key lock:



- 1) **No:** key lock is not active.
- 2) **Yes:** The keys will lock after inactivity.
- 3) **User Password:** the keys will lock after inactivity and the user password will be required to unlock the keypad.

When the keys are locked the display shows the relevant icon () and it will be possible to:

- Display components status by pressing the **LEFT** () and **RIGHT** ().
- Display active alarms by pressing and holding the **ALARM** key ().

When the keys are locked it will **NOT** be possible to:

- Turn the unit on and off via the keypad.
- Access the main menu.
- Delete active alarms.
- Delete active alarms.

To remove the key lock just press the **UP** and **DOWN** ( ) at the same time for a few seconds. An unlock password might be required, this is the **USER** password.

8.3 Unit switch-on

The unit may be switched on and off by pressing the **ON/OFF button** () for a few seconds. The unit's status may be viewed on the display's main page.

If the units are installed in local network, depending on the configuration of the "**Dynamic ON-OFF**" parameter (Manufacturer's set-up-Local network configuration), it will be possible to switch on or off simultaneously all the units in a local network.

When it is on (**Unit ON**), the unit may be controlled via the digital OFF input remotely and via the supervision system/BMS MODBUS.

8.3.1 OFF via remote and via supervisory/BMS MODBUS SYSTEM

After being started from the terminal, the unit may be turned off and on via a digital OFF input remotely and via the supervision system/BMS MODBUS.

For reasons of operator safety, should the unit be set to OFF from the display, the unit may not be started in any way via the digital OFF input remotely and via the supervision system/BMS MODBUS.

The unit's switch on priority is therefore as follows:



A	On/Off from display
B	Off via remote
C	Off via supervisory/BMS MODBUS system

8.3.2 Automatic RE-START due to power failure

The control software features an automatic re-start function in case of power supply failure. Should there be a power supply line outage, when it is restored *c-pro 3 kilo CLOSE* will resume the operation mode prior to the problem.

Resuming previous operation will only be possible if, upon restarting, the unit has no shut-down alarms that prevent switching back on.

8.3.3 Power supply failure alarm

With parameter "Power supply failure alarm" (Manufacturer's set-up - Alarms management configuration) it is possible to enable an alarm to alert the user that *c-pro 3 kilo CLOSE* has undergone a restart due to a power outage.

The parameter makes it possible to choose the alarm triggering type:

- 1) **Disabled:** No alarm is generated in the event of restart due to power failure.
- 2) **Enabled:** The alarm will ALWAYS be generated at the next *c-pro 3 kilo CLOSE* restart.
- 3) **Unit ON:** The alarm will be generated at the next *c-pro 3 kilo CLOSE* restart only if the unit was operating (**Unit ON**). If the unit was off (**Unit OFF**), no alarm will be generated.

When it is configured, *c-pro 3 kilo CLOSE* restart following a power failure will generate the "Power supply failure alarm" to alert the user to the problem.

8.4 Motorised shutters control

The regulation software is able to control motorised shutters, whose function is to isolate the unit from the environment when it is off.

Upon switching on (Unit ON) *c-pro 3 kilo CLOSE* will start opening the shutters. When the digital shutter status input (ID2) is **OPEN (Shutter open)** the fans will be started.

With parameter "Shutter status alarm delay" (Manufacturer's set-up - Alarms management configuration) it is possible to set an alarm trigger delay at switch on, to allow the motor to open the shutter.

If the digital shutter status input is **CLOSED (Shutter closed)**, at the end of the opening periods or during normal unit operation, the "**Shutter status alarm**" will be triggered, which will stop unit operation.

8.5 Air supply fans regulation

c-pro 3 kilo CLOSE has the possibility to control one or more air supply fans with various types of control. The type of control is connected to the fan's features.

With the "**Number of fans**" parameter (Manufacturer Setup - Ventilation configuration) it is possible to configure the number of fans installed in the unit.

With the "**Type of fans**" parameter (Manufacturer Setup - Ventilation configuration) it is possible to configure the fan control choosing from the following types.

- 1) **On-off:** The fans will be controlled via a digital output.
- 2) **Analogue:** The fans will be controlled via a digital output and a 0-10 V analogue output.
- 3) **MODBUS:** The fans will be controlled via MODBUS master communication protocol.

8.5.1 Fixed speed variable fans control

With the "**Type of regulation**" parameter (Manufacturer Setup - Ventilation configuration) it is possible to configure the fan regulation setting a fixed operating speed.

With the "**Maximum fan speed**" parameter (Manufacturer Setup - Ventilation configuration) it is possible to configure the operation speed you wish to maintain.

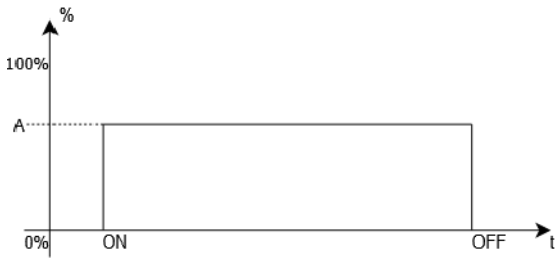

A Maximum fan speed (Manufacturer Setup - Ventilation configuration)

8.5.2 Regulation of modulating fans proportionally to the cooling or heating request

With the "Type of regulation" parameter (Manufacturer Setup - Ventilation configuration) it is possible to configure the fan regulation so as to modulate the speed according to the cooling or heating request. This can result in significant energy savings and a reduction in noise levels, particularly with partial loads.

With the "Minimum fan speed" parameter (Manufacturer Setup - Ventilation configuration) it is possible to configure the minimum operation speed at which the fan may regulate.

With the "Maximum fan speed" parameter (Manufacturer Setup - Ventilation configuration) it is possible to configure the maximum operation speed at which the fan may regulate.

Setting minimum speed at a value below 30% is not recommended because this might prevent correct detection of ambient temperature and humidity. In the event of direct expansion unit with electric coils the fan will be maintained at maximum speed until the component switches off, in order to prevent regulation problems.

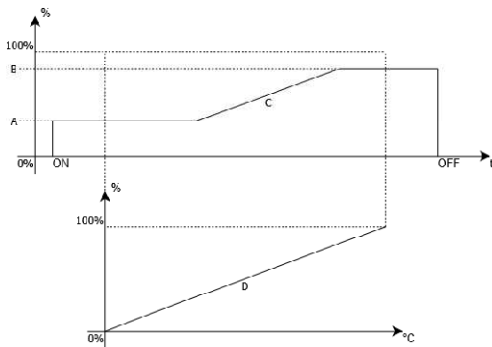

A Minimum fan speed" (Manufacturer Setup - Ventilation configuration)
B Maximum fan speed" (Manufacturer Setup - Ventilation configuration)
C Fan modulation area
D Cooling or heating request

8.5.3 Adjustment of constant air flow variable speed fans

With the "Type of regulation" parameter (Manufacturer Setup - Ventilation configuration) it is possible to configure fan regulation so as to modulate the speed according to the air flow, in order to keep it constant with respect to parameter "Air flow setpoint" (User setup - Ventilation set-point).

In order to calculate air flow rate, the unit requires a pressure sensor installed inside the machine and connected with the fan nozzle.

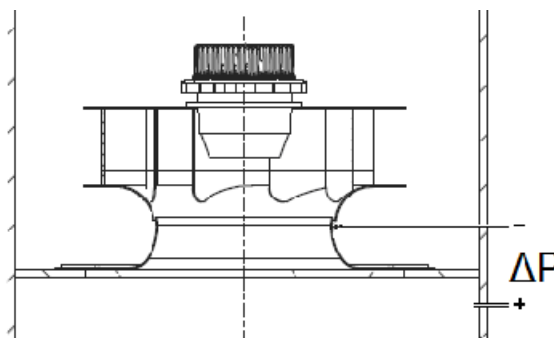

With the “**Differential air pressure**” parameter (Manufacturer Setup - Probe configuration) it is possible to configure the air differential pressure sensor presence.

Flow rate will be calculated based on the following mathematical function:

$$V = \sqrt{\Delta P} * k$$

Where:

- **V** is the flow rate in m3/h
- **ΔP** is the measured pressure difference
- **K** is the fan's characteristic coefficient, parameter “**Air flow coefficient**” (Manufacturer set-up - Ventilation configuration)

Fan speed will be increased or decreased, in order to reach the set-point. A 100 m3/h neutral zone makes it possible to stabilise fan speed.

With the “**Minimum fan speed**” parameter (Manufacturer Setup - Ventilation configuration) it is possible to configure the minimum operation speed at which the fan may regulate.

With the “**Maximum fan speed**” parameter (Manufacturer Setup - Ventilation configuration) it is possible to configure the maximum operation speed at which the fan may regulate.

This type of regulation is optimal to assure constant flow rate even in the event of variable system load losses (e.g. dirty filters) which might reduce it considerably.

8.5.4 Constant pressure variable fans control

With the “**Type of regulation**” parameter (Manufacturer Set-up - Ventilation configuration) it is possible to configure fan regulation so as to modulate the speed according to ambient pressure, in order to keep it constant with respect to parameter “**Air pressure set-point**” (User set-up - Ventilation set-point).

In order to calculate air pressure, the unit requires a pressure sensor installed inside the machine.

With the “**Differential air pressure**” parameter (Manufacturer Setup - Probe configuration) it is possible to configure the air differential pressure sensor presence.

Fan speed will be increased or decreased, in order to reach the set-point. A 2 Pa neutral zone makes it possible to stabilise fan speed.

With the “**Minimum fan speed**” parameter (Manufacturer Setup - Ventilation configuration) it is possible to configure the minimum operation speed at which the fan may regulate.

With the “**Maximum fan speed**” parameter (Manufacturer Setup - Ventilation configuration) it is possible to configure the maximum operation speed at which the fan may regulate.

This regulation is ideal for rooms with air distribution from the raised floor, especially in the following cases:

- Premises intended for future expansion: In these cases the floor is "opened" during expansion steps and pressure will tend to drop as a consequence. The unit will therefore be able to offset by increasing fan speed assuring optimal air distribution.
- Premises subject to constant maintenance. In these cases the floor is opened during maintenance operations and pressure will tend to drop as a consequence. The unit will therefore be able to offset by increasing fan speed assuring optimal air distribution.

8.5.5 Starting speed control

If modulating fan regulation is set, it will be possible to configure a start-up period. During the set start-up period the fans will be overridden at start-up speed. At the end of the start-up time the fans will start regulating normally.

With the “**Start-up fan speed**” parameter (Manufacturer Set-up - Ventilation configuration) it is possible to configure the operation speed at which the fan is regulated during the start-up period.

With the “**Fan start-up time**” parameter (Manufacturer Set-up - Fan configuration) it is possible to configure the fans' startup period duration.

This function is optimal to reach more quickly the work condition at the unit's start, with no need to wait for the modulation period required for reaching the set-point.

8.5.6 Fan alarm management

If the fans are controlled via 0-10 V signal or digital On-Off, the alarm will be managed via the relevant digital input. In case one or more fans should be in alarm, *c-pro 3 kilo CLOSE* will trigger the “**General supply fans alarm**”, which will stop unit operation.

If the fans are controlled via MODBUS connection, *c-pro 3 kilo CLOSE* is able to detect the following alarm conditions of each fan installed in the unit, triggering the “**Fan inverter alarm (1-2-3-4-5)**” in which the nature of the problem is specified. The following alarm causes are possible:

- **Communication failure:** *c-pro 3 kilo CLOSE* constantly monitors correct communication with the fans' control module in order to assure their correct operation.
- **Phase/power supply failure alarm:** The fans' control electronic constantly checks for motor power supply. The check is carried out on every individual motor phase.
- **High regulation module temperature:** The fans' control electronics constantly check the control module's temperature in order to prevent damage due to excessively high temperatures.
- **High motor temperature:** The fans' control electronics constantly check the motor temperature in order to prevent damage due to excessively high temperatures.
- **Regulation module malfunction:** The fans' control electronics constantly check the control module's status and alerts to any damage.
- **Motor overload:** The fans' control electronics constantly check the motor status and alerts to any overload.
- **Low DC power supply:** The fans' control electronics constantly check the control module's status and alerts to any DC power supply reduction.
- **Master-slave communication failure:** The fans' control electronics constantly check the communication status with the slave fans and alerts to any communication failure.
- **Hall sensor error:** The fans' control electronics constantly check the Hall sensor status and alerts to any damage.

8.5.7 Air differential pressure sensor alarm

If the unit is fitted with differential pressure sensor for controlling the fans, it will be constantly monitored.

In the event the differential air pressure sensor should be broken or disconnected *c-pro 3 kilo CLOSE* will trigger the "**Broken air differential pressure sensor alarm**".

In the event of broken or disconnected pressure sensor *c-pro 3 kilo CLOSE* will stop speed regulation at the last value at which the set-point was reached. If the set-point has never been reached the speed is blocked at 50% or at start-up speed, if set.

8.6 Temperature regulation

8.6.1 Temperature control type

All units are fitted with two operating temperature detection probes. One probe is located in the ambient air intake section and is defined as "**Return temperature probe**", while another probe is placed in the ambient air supply compartment and is defined as "**Supply temperature probe**".

With the "**Regulation sensor**" parameter (User Set-up - Temperature regulation) it is possible to configure which probe is designated to temperature control. The type of control is normally connected to the type of system one wishes to implement. The following controls may be selected:

- **Return temperature regulation:** *c-pro 3 kilo CLOSE* uses the return temperature value to regulate the temperature. This setting is ideal for rooms where the thermal loads are consistently distributed.
- **Supply temperature regulation:** *c-pro 3 kilo CLOSE* uses the supply temperature value to regulate the temperature. This setting is ideal for rooms where the thermal loads are not consistent, and the return temperature might not be correct.

8.6.2 Setting the temperature set-point limits

Should it be required to limit the setting field of the temperature regulation set-point, it is possible to configure its minimum and maximum limit:

With the "**Minimum temperature set-point limit**" parameter (Manufacturer Set-up - Set-point limit configuration) it is possible to configure the minimum setting limit of the temperature set-point.

With the "**Maximum temperature set-point limit**" parameter (Manufacturer Set-up - Set-point limit configuration) it is possible to configure the maximum setting limit of the temperature set-point.

This function is ideal to prevent excessively high or low regulation values to be set, which might create problems in the system.

8.6.3 Temperature regulation neutral zone setting

In order to prevent continuous swings of the cooling or heating request near the regulation set-point, it is possible to configure a regulation neutral zone which will deviate the regulation start point from the set-point. See the following chapters for further information.

With the "**Temperature neutral zone**" parameter (Manufacturer Set-up - Neutral zone configuration) it is possible to configure the temperature regulation neutral zone.

This function is ideal for systems where the thermal loads are highly variable and there might be over-regulation near the set-points.

8.6.4 Proportional temperature regulation

With the "Regulation type" parameter (User Set-up - Temperature regulation) it is possible to configure the "P" (Proportional) regulation type for temperature control.

This type of regulation is ideal in cases where the "force" of actuators should be directly proportional to the "distance" of the regulation magnitude from the ideal setting (Set-point), with respect to the maximum setting that should be obtained (Proportional band).

This type of regulation will always tend to have a **fully operational regulation error**, i.e. a deviation of the temperature from the set-point. The width of the deviation will vary according to the correctness of the unit's sizing with respect to the system thermal load: the more over-sized the unit, the greater the deviation when fully operational.

The control output of the components is therefore regulated according to the following function:

$$Out_p = \frac{100}{Bp} * (In - Set)$$

Where:

- **Bp** is the "Proportional band" parameter (User set-up - Temperature regulation)
- **In** is the controlled temperature value
- **Set** is the "Temperature set-point" parameter (Main menu - Set-point)

The following graph shows proportional regulation, with and without neutral zone:

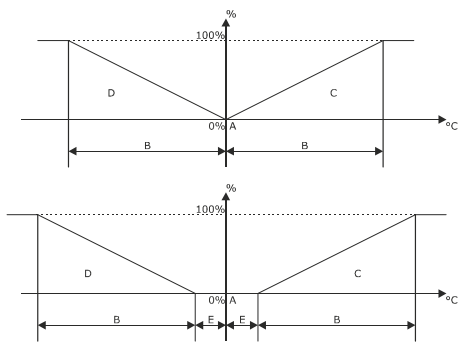

- A Temperature set-point (Main menu - Set-point)**
- B Proportional band (User set-up- Temperature regulation)**
- C Cooling regulation**
- D Heating regulation**
- E Temperature neutral zone (Manufacturer Set-up - Neutral zone configuration)**

The following graph shows the system's response to proportional regulation in cooling. The heating response will be the mirror opposite.

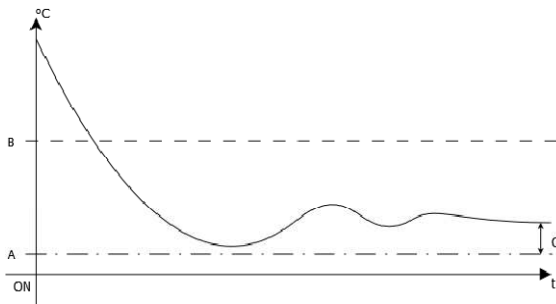

- A Temperature set-point (Main menu - Set-point)**
- B Proportional band (User set-up- Temperature regulation)**
- C Fully operational regulation error**

8.6.5 Proportional + integral temperature regulation

With the "Regulation type" parameter (User Set-up - Temperature regulation) it is possible to configure the "PI" (Proportional + Integral) regulation type for temperature control.

This type of regulation is ideal in cases where one wishes to reduce to the minimum the **Fully operational regulation error**, thus increasing regulation precision over time.

Proportional + Integral regulation adds to the "Proportional error" (previous chapter) the so-called "Integral Error", which allows the controller to retain the memory of past "Proportional error" values. This property gives "PI" regulation the ability to make the process as close as possible to the required point of reference.

The control output of the components is therefore regulated according to the following function:

$$Out_{pi} = Out_p + \frac{100}{Bp * Ti} \int (In - Set) dt$$

Where:

- **Out_p** is the proportional error (previous chapter)
- **Bp** is the "Proportional band" parameter (User set-up - Temperature regulation)
- **Ti** is the "Integration Time" parameter (User set-up - Temperature regulation)
- **In** is the controlled temperature value
- **Set** is the "**Temperature set-point**" parameter (Main menu - Set-point)

Unlike Proportional regulation, whose control output will be at 0% upon reaching the Set-point, in Proportional + Integral regulation the control output will tend to be subject to **Over-regulation** due to integral action. Hence there may be **Out_{pi}** values higher than 0% even when the controlled value is lower than the Set-point. **Over-regulation** will tend to decrease over time until close to 0%. The following graph shows the system's response to Proportional + Integral regulation in cooling. The heating response will be the mirror opposite.

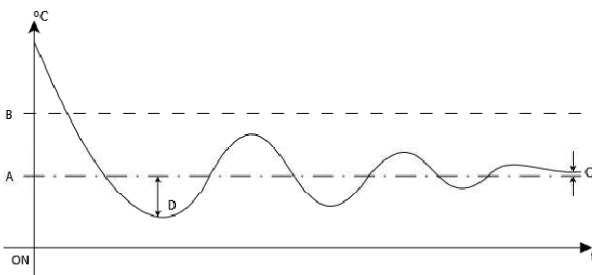

Where:

- A Temperature set-point (Main menu - Set-point)**
- B Proportional band (User set-up - Temperature regulation)**
- C Fully operational regulation error**
- D Over-regulation**

Regulation optimisation may require a certain amount of time since the system has to operate for at least 30 minutes to assure mathematical calculation is optimised. If, after 30 minutes have elapsed, the system still appears to be very unstable, the parameters will need to be changed again and tests be started again.

In order to reduce test times we suggest entering the following values:

- "**Proportional band**" parameter (User set-up - Temperature regulation): **10.0 °C**
- "**Integration Time**" parameter (User set-up - Temperature regulation): **180 s**

8.6.6 Proportional + integral + derivative temperature regulation

With the "**Regulation type**" parameter (User Set-up - Temperature regulation) it is possible to configure the "PID" (Proportional + Integral + Derivative) regulation type for temperature control.

This type of regulation is ideal in cases where one wishes to reduce to the minimum the **Fully operational regulation error** and **Over-regulation**, thus making temperature control more stable and precise.

"**PID**" regulation adds to Proportional + Integral regulation the so-called "**Derivative error**", which makes it possible to take into account the "speed" with which the magnitude changes, and therefore to correct the control output more quickly.

The control output of the components is therefore regulated according to the following function:

$$Out_{pid} = Out_p + Out_{pi} + \frac{100}{Bp} * Td \frac{d(In - Set)}{dt}$$

Where:

- **Out_p** is the proportional error (previous chapter)
- **Out_{pi}** is the proportional+integral error (previous chapter)
- **Bp** is the "Proportional band" parameter (User set-up - Temperature regulation)
- **Td** is the "**Derivation Time**" parameter (User set-up - Temperature regulation)
- **In** is the controlled temperature value
- **Set** is the "**Temperature set-point**" parameter (Main menu - Set-point)

The following graph shows the system's response to Proportional + Integral + Derivative regulation in cooling. The heating response will be the mirror opposite.

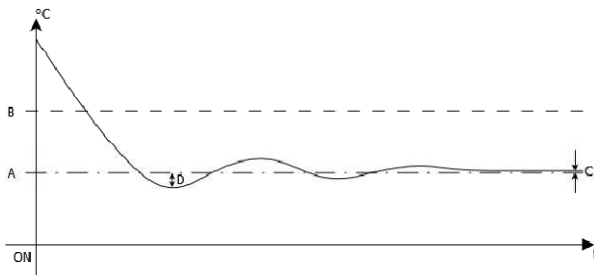

Where:

- A Temperature set-point (Main menu - Set-point)**
- B Proportional band (User set-up - Temperature regulation)**
- C Fully operational regulation error**
- D Over-regulation**

Regulation optimisation may require a certain amount of time since the system has to operate for at least 30 minutes to assure mathematical calculation is optimised. If, after 30 minutes have elapsed, the system still appears to be very unstable, the parameters will need to be changed again and tests be started again.

In order to reduce test times we suggest entering the following values:

- "Proportional band" parameter (User set-up - Temperature regulation): **40.0 °C**
- "Integration Time" parameter (User set-up - Temperature regulation): **60 s**
- "Derivation Time" parameter (User set-up - Temperature regulation): **1 s**

8.6.7 High or low temperature alarm

With parameters "High temperature alarm offset" (User set-up - Temperature regulation) and "Low temperature alarm offset" (User set-up - Temperature regulation) it is possible to configure two alarm thresholds for temperature control.

Exceeding these thresholds will trigger the "High regulation temperature alarm" or the "Low regulation temperature alarm" to alert the operator to any problems.

High and low temperature alarm triggering is not a shutdown problem for the unit that will continue operating regularly. With the "Temperature and humidity alarms delay" parameter (Manufacturer Set-up - Alarms management configuration) it is possible to delay alarm triggering.

Alarm triggering is defined by the following formulas:

$$Al_{Ht} = In > Set + Offset_{Ht}$$

$$Al_{Lt} = In < Set - Offset_{Lt}$$

Where:

- **Al_{Ht}** is the high temperature alarm
- **Al_{Lt}** is the low temperature alarm
- **In** is the controlled temperature value
- **Set** is the "Temperature set-point" parameter (Main menu - Set-point))
- **Offset_{Ht}** is the "High temperature alarm offset" parameter (User set-up - Temperature regulation)
- **Offset_{Lt}** is the "Low temperature alarm offset" parameter (User set-up - Temperature regulation)

8.6.8 Air temperature probes alarm management

In the event the return temperature probe should be broken or disconnected *c-pro 3 kilo CLOSE* will trigger the "Broken return temperature probe alarm".

In the same way, in the event the supply temperature probe should be broken or disconnected *c-pro 3 kilo CLOSE* will trigger the "Broken supply temperature probe alarm".

In order not to interrupt temperature regulation, *c-pro 3 kilo CLOSE* will use the working sensor as valid value. In the event both probes should be broken, temperature regulation will be stopped.

8.7 Limit temperature regulation

8.7.1 Limit temperature

With the "**Regulation sensor**" parameter (User Set-up - Temperature regulation) it is possible to configure which probe is designated to temperature control. In the event the return temperature should be controlled, limits for the supply temperature may be set in order to ensure the air let into the room is neither too hot or too cold.

8.7.2 High and low limit temperature management

With parameters "**Limit temperature upper limit**" (User set-up - Limit temperature regulation) and "**Limit temperature lower limit**" (User set-up - Temperature regulation) it is possible to configure two alarm thresholds for the limit temperature.

Exceeding these thresholds will trigger the "**High limit temperature alarm**" or the "**Low limit temperature alarm**" to alert the operator to any problems.

High and low limit temperature alarm triggering is not a shutdown problem for the unit that will continue operating regularly. With the "**Temperature and humidity alarms delay**" parameter (Manufacturer Set-up - Alarms management configuration) it is possible to delay alarm triggering.

Alarm triggering is defined by the following formulas:

$$Al_{Hlt} = In > Limit_{Hlt}$$

$$Al_{Llt} = In < Limit_{Llt}$$

Dove:

- **Al_{Hlt}** is the high limit temperature alarm
- **Al_{Llt}** is the low limit temperature alarm
- **In** is the limit temperature value
- **Limit_{Hlt}** is the "**Limit temperature upper limit**" parameter (User set-up - Limit temperature regulation)
- **Limit_{Llt}** is the "**Limit temperature lower limit**" parameter (User set-up - Limit temperature regulation)

8.8 Humidity regulation

8.8.1 Humidity probe configuration

The units may be fitted with a humidity probe, parameter **"Humidity"** (Manufacturer set-up - Probe configuration), that lets you view the air humidity reading.

8.8.2 Setting humidity set-point limits

Should it be required to limit the setting field of the humidity regulation set-point, it is possible to configure its minimum and maximum limit:

With the **"Minimum humidity set-point limit"** parameter (Manufacturer Set-up - Set-point limit configuration) it is possible to configure the minimum setting limit of the humidity set-point.

With the **"Maximum humidity set-point limit"** parameter (Manufacturer Set-up - Set-point limit configuration) it is possible to configure the maximum setting limit of the humidity set-point.

This function is ideal to prevent excessively high or low regulation values to be set, which might create problems in the system.

8.8.3 Humidity regulation neutral zone setting

In order to prevent continuous swings of the dehumidification and humidification request near the regulation set-point, it is possible to configure a regulation neutral zone which will deviate the regulation start point from the set-point. See the following chapters for further information.

With the **"Humidity neutral zone"** parameter (Manufacturer Set-up - Neutral zone configuration) it is possible to configure the humidity regulation neutral zone.

This function is ideal for systems where the thermal loads are highly variable and there might be over-regulation near the set-points.

8.8.4 Humidity proportional regulation

With the "Dehumidification" parameter (Manufacturer Set-up - Humidity regulation configuration) it is possible to enable dehumidification operation. Dehumidification is regulated with the Proportional system.

The control output of the components is therefore regulated according to the following function:

$$Out_p = \frac{100}{Bp} * (In - Set)$$

Where:

- **Bp** is the **"Proportional dehumidification band"** parameter (User set-up - Humidity regulation)
- **In** is the controlled humidity value
- **Set** is the **"Humidity set-point"** parameter (Main menu - Set-point)

Dehumidification is only activated when the control output reaches parameter **"Dehumidification trigger threshold"** (Manufacturer set-up - Humidity regulation configuration).

With parameter **"Minimum dehumidification limit"** (Manufacturer set-up - Humidity regulation configuration) it will be possible to limit regulation to prevent the request from being too low, and therefore dehumidification effect not being sufficient.

This is because the dehumidification effect is only possible with a very low air temperature, therefore with very high cooling request.

The following graph shows proportional regulation, with and without neutral zone:

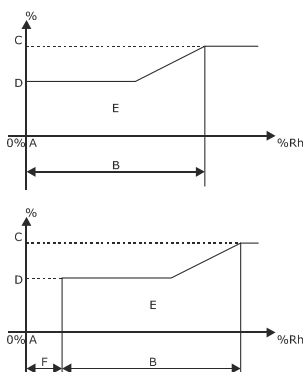

- A Humidity set-point (Main menu - Set-point)**
- B Dehumidification proportional band (User set-up - Humidity regulation)**
- C Dehumidification trigger threshold(Manufacturer set-up - Humidity regulation configuration)**
- D Minimum dehumidification limit(Manufacturer set-up - Humidity regulation configuration)**
- E Cooling regulation**
- F Humidity neutral zone (Manufacturer Set-up - Neutral zone configuration)**

8.8.5 Partial dehumidification

With the "**Partial dehumidification**" parameter (Manufacturer Set-up - Humidity regulation configuration) it is possible to inhibit activation of the second compressors in dehumidification operation.

This function is ideal in systems whose ambient thermal load and any unit heating triggering, is not enough to offset activation of both compressors, excessively cooling the room.

When this function is enabled the set-point might be reached in a longer time than with conventional regulation.

8.8.6 Dehumidification lock

With parameter "**Dehumidification lock offset**" (Manufacturer set-up - Humidity regulation configuration) it is possible to enter a temperature offset which, when exceeded, interrupts the dehumidification request to prevent ambient temperature from dropping too low.

This function is ideal in systems whose ambient thermal load and any unit heating triggering, is not enough to offset dehumidification activation, excessively cooling the room.

When this function is enabled the set-point might be reached in a longer time than with conventional regulation.

Dehumidification lock triggering is defined by the following formula:

$$Dh_{stop} = In < Set - Offset_{dh}$$

Where:

- **In** is the controlled temperature value
- **Set** is the "**Temperature set-point**" parameter (Main menu - Set-point)
- **Offset_{dh}** is the "**Dehumidification lock offset**" parameter (Manufacturer set-up - Humidity regulation set-up)

8.8.7 Humidifier presence setting

With the "**Humidifier**" parameter (Manufacturer Set-up - Humidity regulation configuration) it is possible to configure the presence of a humidification system for room humidification regulation.

The parameter makes it possible to select the following humidification regulation types:

- No** There is no type of humidification regulation in the unit, hence it will be disabled.
- Si** The unit or system features an external humidifier (not integrated with the controller). Humidifier interfacing will take place with 0-10 V analogue signal.

8.8.8 Humidification production percentage

With the "**Humidification production percentage**" parameter (Manufacturer Set-up - Humidity regulation configuration) it is possible to configure the maximum limit of the humidifier control output, in order to reduce steam production.

This function is ideal in systems where maximum humidifier production is too high and there may be steam over-production issues and possible formation of condensate inside the unit.

8.8.9 Steam production during cooling

With the "**Joint humidification and cooling**" parameter (Manufacturer Set-up - Humidity regulation configuration) it is possible to enable steam production at the same time as cooling.

During cooling, steam production should normally be stopped in order to prevent formation of condensate inside the unit, owing to low air temperature.

This function makes it possible, in systems where steam production is required even during cooling (areas with very cold climate), to prevent issues due to a drastic drop in ambient humidity.

This function is not recommended in direct expansion units, as the supply air temperature may be very low and lead to condensate formation.

8.8.10 Humidification proportional regulation

With the "**Enable humidification**" parameter (User Set-up - Humidifier regulation) it is possible to enable humidification operation. Humidification is regulated with the proportional system.

Proportional humidification regulation offers a modulation effect of the amount of steam produced by the humidification system.

For maximum and minimum limits, please refer to the humidifier features.

The control output of the components is therefore regulated according to the following function:

$$Out_p = \frac{100}{Bp} * (In - Set)$$

Where:

- **Bp** is the "Proportional humidification band" parameter (User set-up - Humidity regulation)
- **In** is the controlled humidity value
- **Set** is the "Humidity set-point" parameter (Main menu - Set-point)

The following graph shows proportional regulation, with and without neutral zone:

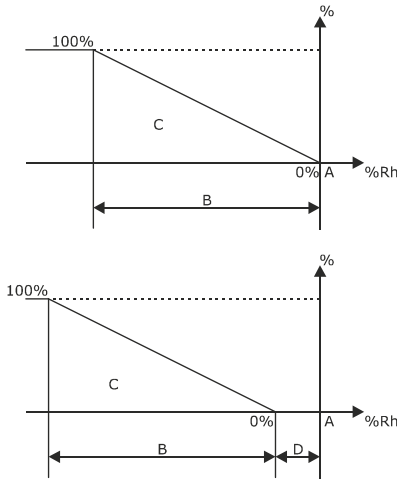

- A** Humidity set-point (Main menu - Set-point)
- B** Humidificationproportionalband(Usersetup - Humidity regulation)
- C** Humidification regulation
- D** Humidity neutral zone (Manufacturer Set-up - Neutral zone configuration)

8.8.11 Manual humidifier water drain

In order to carry out routine humidifier maintenance, it might be required to force emptying water from the cylinder. With the "Manual drain" parameter (User Set-up - Humidifier regulation) it is possible to manually drain water from the steam cylinder to remove it for maintenance.

8.8.12 Lines and humidifier cylinder pre-washing management

The pre-washing function allows cleaning the cylinder and water lines, in particular after having carried out the hydraulic connections and/or replaced the cylinder. During washing, the cylinder is filled (with closed contactor) and emptied 3 times to remove any impurities present inside the cylinder and the pipes.

With the "Cylinder pre-washing" parameter (User Set-up - Humidifier regulation) it is possible to enable the pre-washing function. The humidifier will automatically go back to normal operation at the end of the pre-washing function.

8.8.13 High and low humidity alarms

With parameters "High return humidity alarm offset" (User set-up - Humidity regulation) and "Low return humidity alarm offset" (User set-up - Humidity regulation) it is possible to configure two alarm thresholds for humidity control.

Exceeding these thresholds will trigger the "High return humidity alarm" or the "Low return humidity alarm" to alert the operator to any problems.

High and low humidity alarm triggering is not a shutdown problem for the unit that will continue operating regularly. With the "Temperature and humidity alarms delay" parameter (Manufacturer Set-up - Alarms management configuration) it is possible to delay alarm triggering.

Alarm triggering is defined by the following formulas:

$$Al_{Hh} = In > Set + Offset_{Hh}$$

$$Al_{Lh} = In < Set - Offset_{Lh}$$

Where:

- **Al_{Hh}** is the high return humidity alarm
- **Al_{Lh}** is the low return humidity alarm
- **In** is the return humidity value
- **Set** is the "Humidity set-point" parameter (Main menu - Set-point)

- **Offset_{th}** is the "High return humidity alarm offset" parameter (User set-up - Humidity regulation)
- **Offset_{lh}** is the "Low return humidity alarm offset" parameter (User set-up - Humidity regulation)

8.8.14 Air humidity probes alarm management

In the event the return humidity probe should be broken or disconnected **c-pro 3 kilo CLOSE** will trigger the "Broken return humidity probe alarm".

8.8.15 Humidifier alarm management

The humidifier board controls the internal humidifier's alarm detection. With the MODBUS master protocol **c-pro 3 kilo CLOSE** receives the humidifier's alarm statuses, triggering the "Internal humidifier alarm" and providing the type of extant alarm. See the chapter on alarm management for further information.

With the "Configurable output (1-2-3-4)" parameter (Manufacturer Set-up - digital output configuration) it is possible to configure one of the four digital outputs in order to provide the "General external humidifier alarm".

Both alarms stop humidifier regulation.

8.9 Direct expansion unit regulation

8.9.1 General information

With the "Machine type configuration" parameter (Manufacturer Set-up - Machine type configuration) it is possible to configure the type of temperature regulation with direct expansion system (**Direct Expansion**).

Direct expansion units exploit the properties of refrigerant gas to cool air. The main regulation components of direct expansion units is the compressor (or compressors in the event of multi-circuit units).

8.9.2 Management of ON-OFF compressor

Il **c-pro 3 kilo CLOSE** is able to control up to 2 compressors on 2 separate cooling circuits. The following pictures show the start-up diagram of the compressors with Proportional temperature regulation:

With the "Number of compressors" parameter (Manufacturer Set-up - Direct expansion configuration) it is possible to configure the number of compressors installed in the unit.

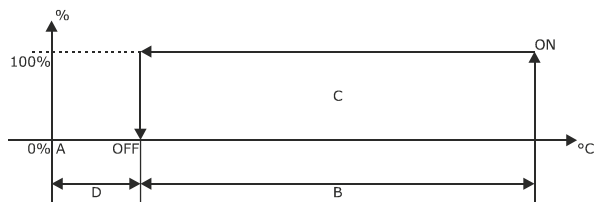

Regulation with 1 compressor

- A Temperature set-point (Mainmenu - Set-point)**
- B Proportional band (User set-up- Temperature regulation)**
- C Compressor 1**
- D Temperature neutral zone (Manufacturer Set-up - Neutral zone configuration)**
- E Compressor 2**

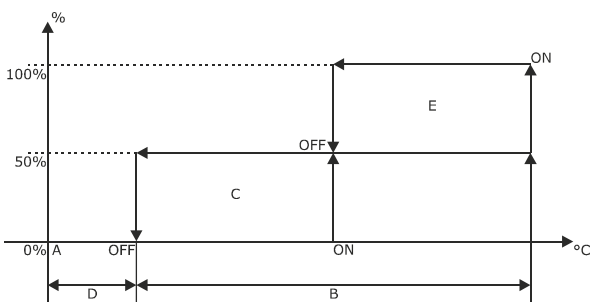

Regulation with 2 compressors

8.9.3 ON-OFF compressor automatic rotation

With the "Type of compressor rotation" parameter (Manufacturer Set-up - Direct expansion configuration) it is possible to configure the rotation type of ON-OFF compressors.

Rotation of non-regulated compressors makes it possible to choose the compressor actuation logic in order to balance the hours of compressor operation as much as possible. Two different types of rotation can be set:

- **FIFO + HS:** FIFO (First In - First Out) rotation ensures the first compressor to switch on is always the first to switch off. The first compressor to be switched on is defined with HS logic (Hours and Start-up). HS logic takes into account both operating hours and the number of start-ups of the compressors. The compressor with the lowest number of operating hours + startups will be started first.

- **LIFO + HS:** LIFO (Last In - First Out) rotation ensures the last compressor to switch on is always the first to switch off. The first compressor to be switched on is defined with HS logic (Hours and Start-up). HS logic takes into account both operating hours and the number of start-ups of the compressors. The compressor with the lowest number of operating hours + startups will be started first.

8.9.4 Compressor management with inverter regulation

With the "Enable compressor inverter" parameter (Manufacturer Set-up - Direct expansion configuration) it is possible to configure the regulation type of inverter compressors. Two different types of regulation can be set:

- 1) No: There is no type of compressor regulation in the unit, hence it will be disabled.
- 2) Yes: The unit or system features an external inverter (not integrated with the controller). Inverter interfacing will take place with 0-10 V analogue signal.

The inverter compressor will always be installed on Circuit 1, therefore in case of regulation with 2 compressors rotation will be disabled. The following pictures show the start-up diagram of the compressors with Proportional temperature regulation:

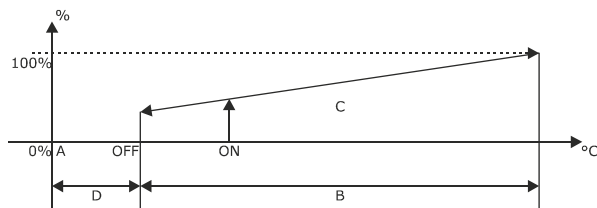

Regulation with 1 compressor

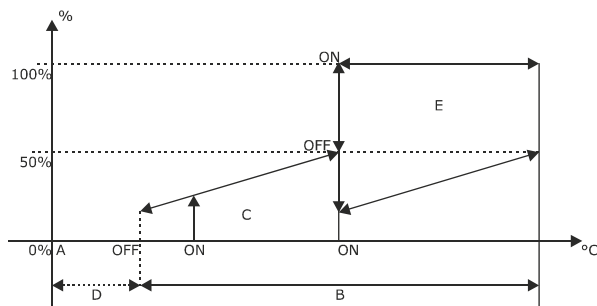

Regulation with 2 compressors

- A Temperature set-point (Main menu - Set-point)**
- B Proportional band (User set-up- Temperature regulation)**
- C Compressor 1**
- D Temperature neutral zone (Manufacturer Set-up - Neutral zone configuration)**
- E Compressor 2**

8.9.5 Superheating regulation with electronic expansion valve (only if present)

Optimal operation of cooling circuits is mainly connected to refrigerant Superheating value regulation on evaporator outlet. **Superheating - SH** refers to the **difference between evaporation temperature and suction temperature of the compressor**. Correct **Superheat - SH** value not only assures the compressor is protected from damage due to sudden liquid refrigerant backflow, but also ensures the compressor always operates at the best possible condition, reducing the electrical current absorbed by the compressor motor.

In order to achieve optimal of Superheat - SH regulation all direct expansion units are fitted with **Electronic expansion valve EEV**, whose positioning precision assures constant modulation of the refrigerant flow into the evaporation coil.

Valve modulation is controlled by the EVDrive control module through a specific algorithm. **Superheating - SH** value is calculated through the readings transmitted by the probes installed on the suction section of the compressor. Two probes are used for calculation:

- **Suction pressure probe:** This probe detects pressure of the evaporation coil, through which it is possible to calculate the evaporation temperature.
- **Suction temperature probe:** This probe detects compressor suction temperature.

The Superheating (SH) value is compared with the superheating set-point (6.0 K) and the valve opening percentage is calculated, with a PID algorithm, to maintain Superheating (SH) constant near the set-point.

The EVDrive control module, in addition to superheating regulation, is also able to control some safety algorithms required to protect the compressor. These algorithms will be explained in the following chapters.

8.9.6 Condensation pressure and temperature detection

Il valore di pressione e temperatura di condensazione è indispensabile per il funzionamento del circuito frigorifero. Tramite un sensore di pressione, il microprocessore **c-pro 3 kilo CLOSE** rileva costantemente il valore di pressione di condensazione e ne calcola il valore di temperatura equivalente.

8.9.7 De-superheating management (aggiungere i parametri relativi alla funzione)

De-superheat - DSH refers to the **difference between compressor drain temperature and compressor condensation temperature**.

In a correctly operating unit the de-superheat value should be between 20.0 K and 30.0 K. *c-pro 3 kilo CLOSE* constantly monitors the de-superheat value and implements the following regulations:

- **In the event de-superheat should be lower than 20 K liquid may flow back to the compressor.** To counter this phenomenon the superheating set-point will be raised up to 12.0 K.
- **In the event de-superheat should be higher than 30 K there is no liquid backflow risk.** Therefore, in view of the "favourable" condition in relation to compressor safety, it is possible to reduce the superheat set-point to increase system efficiency (condensation pressure decrease and evaporation pressure increase) up to minimum 5.0 K.

8.9.8 Control of early valve opening upon compressor start-up

In order to reduce compressor load upon start-up (ΔP between suction and supply), and consequently electrical motor breakaway, the expansion valve control driver manages an early valve opening algorithm.

In the event of compressor start-up request, the expansion valve will open at 100% for 5 seconds in order to balance circuit pressures, after which the compressor will be started.

8.9.9 Low Superheat (LoSH) management

A **Low Superheat - LoSH** figure may indicate a less than optimal operating condition, which might lead to liquid flowing back to the compressor.

The expansion valve control driver manages an algorithm to monitor low superheat. In the event the superheat pressure figure should exceed the limit figure of **3.0 K**, low superheat status will be displayed on the controller.

8.9.10 High superheat (HiSH) management

A **High Superheat - HiSH** figure may indicate poor refrigerant charge, which does not allow optimal regulation of the **Superheat value (SH)**.

The expansion valve control driver manages an algorithm to monitor high superheat. In the event the superheat pressure figure should exceed the limit figure of **15.0 K**, high superheat status will be displayed on the controller.

8.9.11 High compressor evaporation pressure management (MOP)

Scroll compressors installed in the units entail the need to work at evaporation pressures that do not exceed the figures set by the manufacturer. Exceeding the constructive limit may involve mechanical damage to the compressor.

In order to protect the compressor, the expansion valve control driver manages an algorithm for high evaporation pressure regulation (**Maximum Operating Pressure - MOP**).

Should the evaporation pressure reading exceed the limit of **10.5 Barg (12.0 °C)**, the Superheat set-point (see previous chapters) will be raised in order to reduce valve opening and consequently evaporation pressure. After restoring an acceptable evaporation pressure figure, the control algorithm will go back to regulating the valve normally.

8.9.12 Low compressor evaporation pressure management (LOP)

Scroll compressors installed in the units entail the need to work at evaporation pressures that do not exceed the figures set by the manufacturer. Exceeding the constructive limit may involve mechanical damage to the compressor.

In order to protect the compressor, the expansion valve control driver manages an algorithm for low evaporation pressure regulation (**Low Operating Pressure - LOP**).

Should the evaporation pressure reading exceed the limit of **6.2 Barg (-3 °C)**, valve opening will be forced to the current figure to stop the pressure from continuing to go down, triggering a low pressure alarm. After restoring an acceptable evaporation pressure figure, the control algorithm will go back to regulating the valve normally.

8.9.13 Low evaporation pressure alarm

Suction pressure below the standard readings involves a work overload for the compressor. The refrigerant will be highly superheated on evaporator outflow and will reach the compressor at a temperature above its standard figure. This causes abnormal overheating of the motor coils in particular, and of the compressor's mechanical parts in general.

In order to improve compressor protection, *c-pro 3 kilo CLOSE* constantly monitors evaporation pressure. Should the evaporation pressure reading go below **4 Barg (-14.0 °C)**, the compressor will be stopped to prevent damaging it and the "**Low compressor pressure alarm (1-2)**" will be triggered.

Low outside air temperature might lead to the refrigerant migrating into the condenser. This phenomenon would result in a low pressure condition during the first few minutes of compressor operation.

In order to prevent false alarms, in conditions of low outside temperature, the low pressure alarm is delayed upon compressor start-up. With the "**Low compressor pressure alarm delay**" parameter (Manufacturer Set-up - Alarms management configuration) it is possible to delay alarm triggering.

8.9.14 Management of high compressor discharge temperature

High discharge temperature of the compressor might give rise to several problems with the compressor and cooling circuit.

In order to improve compressor protection, all units are fitted with a compressor discharge temperature probe installed on every circuit. This probe has the purpose of ensuring the discharge temperature does not exceed the compressor's damage threshold.

Discharge temperature is managed through two different trigger thresholds:

- 1) **Discharge temperature protection threshold (110.0 °C)**: Should the discharge temperature exceed this threshold, the compressor request would be reduced in order to maintain the temperature below this threshold. No alarm is triggered by the controller and the unit continues operating regularly. This option is only valid for compressors controlled by inverter.
- 2) **Discharge temperature alarm threshold (115.0°C)**: Should the discharge temperature exceed this threshold, the compressor would be immediately stopped with the "High compressor discharge temperature alarm (1-2)".

In order to prevent false alarms in transient situations, the high discharge temperature alarm is delayed. With the "**High compressor discharge temperature alarm delay**" parameter (Manufacturer Set-up - Alarms management configuration) it is possible to delay alarm triggering.

8.9.15 Failed compression compressor alarm

Excessively small compression ratio, i.e. the ratio between circuit pressures (Condensation pressure/Evaporation pressure) indicates that the compressor is not correctly compressing the refrigerant. Possible causes are mechanical rupture of the compressor, incorrect compressor direction of rotation or incorrect operating condition.

In order to improve compressor protection, *c-pro 3 kilo CLOSE* constantly monitors pressure ratio (Condensation pressure/Evaporation pressure). Should the pressure difference be less than **2.0 Barg**, the compressor will be stopped and the "**Low compression compressor alarm (1-2)**".

8.9.16 High condensation pressure alarm

Condensation pressure above the standard readings involves a work overload for the compressor. Its absorption will tend to rise, with the risk to damage the motor. Furthermore, as the pressure rises so does the risk of damaging the cooling circuit components, due to the high pressure.

In order to improve compressor protection, *c-pro 3 kilo CLOSE* constantly monitors condensation pressure. A manual reset pressure sensor is installed on the circuit and will open the digital input to lock the compressor in the event of high pressure, triggering the "**High compressor pressure alarm (1-2)**".

8.9.17 Compressor thermal magnetic protection alarm

All compressors are electrical fixtures and are therefore protected by thermal magnetic switches in order to preserve the motor and the power line in the event of electrical motor short circuit and overload.

In the event of failure, the thermal magnetic switch will break the power line and open the digital alarm input, triggering the "**Compressor thermal magnetic protection alarm (1-2)**".

8.9.18 Electronic valve alarm management (if present)

The EVDrive valves regulation driver manages all alarms concerning electronic valves triggering the "Compressor electronic expansion valve alarm (1-2)". Driver alarms stop cooling circuit operation. Below is the list of valve alarms:

- **Communication failure**: the alarm indicates failed communication with the c-pro 3 kilo CLOSE regulator.
- **Evaporation pressure probe alarm**: In the event the evaporation pressure probe should be broken or disconnected, the driver will signal the fault to the c-pro 3 kilo CLOSE.
- **Condensation pressure probe alarm**: In the event the condensation pressure probe should be broken or disconnected, the driver will signal the fault to the c-pro 3 kilo CLOSE.
- **Suction temperature probe alarm**: In the event the suction temperature probe should be broken or disconnected, the driver will signal the fault to the c-pro 3 kilo CLOSE.
- **Discharge temperature probe alarm**: In the event the discharge temperature probe should be broken or disconnected, the driver will signal the fault to the c-pro 3 kilo CLOSE.

8.10 Condenser regulation

8.10.1 General information

With parameter "Condenser regulation" (Manufacturer set-up - Condenser regulation configuration) it is possible to configure the type of condenser regulation of direct expansion units. The following types of regulation can be selected:

- 1) **No:** There is no type of condenser regulation in the unit, hence it will be disabled.
- 2) **Proportional:** The condensers will be regulated with a proportional system through a 0-10 V signal.
- 3) **AutoSet-point:** The condensers will be regulated with a proportional system through a 0-10 V signal. The regulation set-point will be calculated automatically based on operating conditions (see following chapters).

8.10.2 Condensers proportional regulation

To avoid condensation temperature over-regulation issues, the condenser is only regulated with compressor on.

The control output of the condensers is therefore regulated according to the following function:

Where:

- **Bp** is the "**Proportional condensation band**" parameter (User set-up - Condenser regulation)
- **In** is the condensation temperature value
- **Set** is the "**Condensation set-point**" parameter (User set-up - Condenser regulation)

$$Out_p = \frac{100}{Bp} * (In - Set)$$

With parameter "**Minimum condensation request**" (Manufacturer set-up - Condensation regulation configuration) it is possible to configure the minimum operating request at which the condenser may be regulated.

With parameter "**Maximum condensation request**" (Manufacturer set-up - Condensation regulation configuration) it is possible to configure the maximum operating request at which the condenser may be regulated.

The following graph shows proportional regulation:

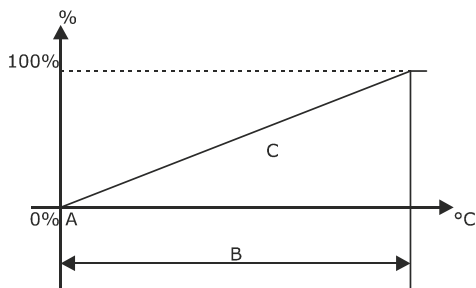

Where:

- A** **Condensation set-point (User set-up - Condenser regulation)**
- B** **Condensation proportional band (User set-up - Condenser regulation)**
- C** **Condenser regulation**

8.10.3 Condenser regulation with AUTASET-POINT

Low condensation temperature makes it possible to achieve compressor energy savings. If condensation temperature regulation is tied to outdoor temperature (e.g. Air or water condensers with dry cooler), during the cold season it is possible to reduce the regulation set-point in order to increase energy savings.

Through condenser regulation with AutoSet-point it is possible, with a suitable algorithm, to achieve the best possible regulation set-point for the condensers' operating conditions.

For optimal AutoSet-point system regulation it is recommended to set parameter "Condensation set-point" (User set-up - Condenser regulation) at the minimum value at which one wishes the condensers to work (e.g. 35°C).

The set-point is regulated in the following manner:

- **LOW OUTDOORS TEMPERATURE CONDITIONS:** As long as outdoor air (or water) temperature is such that condensation temperature remains within the zone defined by parameter "Condensation set-point" (User set-up - Condenser regulation) + parameter "Condensation proportional band" (User set-up - Condenser regulation), regulation type is proportional (see previous chapter).
- **INCREASE IN THE OUTDOOR TEMPERATURE:** Upon increase in outdoor air (or water) temperature, condensation temperature also starts increasing. Upon achieving 100% of the demand, a timer will be started. As soon as the timer exceeds parameter "AutoSet-point time" (Manufacturer set-up - Condenser regulation configuration), parameter "Condensation set-point" (User set-up - Condenser regulation) will be added to parameter "Condensation set-point increase" (User set-up - Condenser regulation). The set-point will be increased until the temperature falls within the new regulation range, up to the maximum equalling parameter "Maximum condensation set-point" (User set-up - Condensers regulation).

- **REGULATION WITH RAISED SET-POINT:** For as long as the set-point is increased, the condensation request will be forced to a minimum value equalling parameter "Minimum AutoSet-point request" (Manufacturer set-up – Condensers regulation configuration). This stops the condensation temperature value from being affected if the set-point is reached.
- **DROP IN OUTDOOR TEMPERATURE:** With a drop in the outdoor air temperature, the condensation temperature tends to fall below the changed set-point. In this case, a timer will start as soon as the condensation temperature is outside of the regulation range. As soon as parameter "AutoSet-point time" is exceeded (Manufacturer set-up – Condensers regulation configuration), parameter "Condensation Set-point increase" (User set-up – Condensers regulation) will be subtracted from the modified set-point. The set-point will decrease until the temperature falls within the regulation range, or until it reaches the parameter "Condensation set-point" (User setup – Condensers regulation).

8.10.4 Start-up request management

In order to improve condenser regulation it is possible to configure a start-up period. During the set start-up period regulation will be overridden at start-up request. At the end of the start-up time regulation will go back to normal proportional operation.

With parameter "**Condensation start-up request**" (Manufacturer set-up - Condensation regulation configuration) it is possible to configure the request at which the condenser will be regulated during the start-up period.

With the "**Condensation start-up time**" parameter (Manufacturer Set-up - Condensation regulation configuration) it is possible to configure the duration of the condensation regulation start-up period.

This function is optimal to reach more quickly the work condition at the unit's start, with no need to wait for the modulation period required for reaching the set-point.

8.10.5 Condenser regulation management with broken probe

In order not to interrupt condenser regulation, in the event of breakdown of the condensation pressure sensor it is possible to override the request at a pre-set value.

With parameter "Override with probe error" (Manufacturer Set-up - Condensation regulation configuration) it is possible to configure the percentage at which the request will be overridden with "Condensation pressure sensor alarm".

8.10.6 Condenser alarm management

In order to detect any issues to do with the condensers, it is possible to configure a digital input as condenser alarm.

With the "**Configurable input (1-2-3-4)**" parameter (Manufacturer Set-up - Digital input configuration) it is possible to configure one of the four digital inputs in order to detect the condenser 1 or 2 alarm.

When configured, the digital input opening will trigger the "**General condenser alarm (1-2)**" which will stop regulation of the condensers and compressors connected to them.

Depending on the setting of parameter "**Compressor alarms severity**" (Manufacturer Set-up - Alarm management configuration), triggering may also stop the unit.

8.11 Evaporating unit regulation for connection to remote condensing unit

8.11.1 General information

With the "**Machine type configuration**" parameter (Manufacturer Set-up - Machine type configuration) it is possible to configure the type of temperature regulation with direct expansion system for connection to remote condensing unit (**Evaporator**).

The units for connection to remote condensing units are supplied without compressors and without expansion valve, as these components are installed in the condensing unit.

8.11.2 Configuration for operation with remote condensing unit

In order to assure system operation with remote condensing unit the unit's control outputs must be configured.

With the "**Configurable output (1-2-3-4)**" parameter (Manufacturer Set-up - Digital output configuration) it is possible to configure one of the four digital outputs in order to provide the condensing unit start up contact.

The 0-10 V modulating cooling request regulation output (AO 2 - External inverter) will make it possible to drive a condensing unit with inverter compressor.

The cooling request will take place in the manner detailed in the previous chapters (Direct expansion).

8.11.3 Condensing unit alarm management

In order to supply the unit with information on the condensing unit's status, it is possible to configure a digital input as general condensing unit alarm.

With the "**Configurable input (1-2-3-4)**" parameter (Manufacturer Set-up - Digital input configuration) it is possible to configure one of the four digital inputs in order to detect the condensing unit alarm.

When configured, digital input opening will trigger the "**General condensing unit alarm**" which will stop condensing unit regulation.

Depending on the setting of parameter "**Compressor alarms severity**" (Manufacturer Set-up - Alarm management configuration), triggering the alarm may also stop the unit.

8.12 Chilled water units regulation

8.12.1 General information

With the "**Machine type configuration**" parameter (Manufacturer Set-up - Machine type configuration) it is possible to configure the type of temperature regulation with chilled water system (**Chilled water**).

Chilled water units use a water system for temperature regulation. The unit's cooling power is modulated by regulating a valve with 0-10 V control signal.

8.12.2 Chilled water circuit management

c-pro 3 kilo CLOSE is able to manage a maximum of one water circuit with regulation via 0-10 V control signal. The following pictures show the valve control diagram with Proportional temperature regulation:

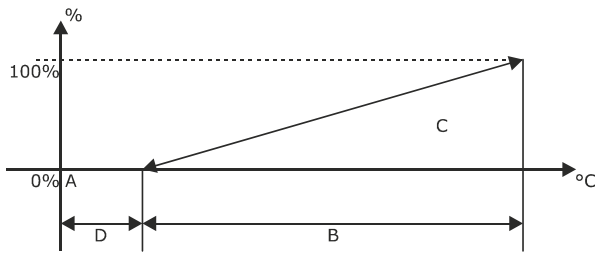

Where:

- A** Temperature set-point (Main menu - Set-point)
- B** Proportional band (User set-up- Temperature regulation)
- C** Valve Regulation
- D** Temperature neutral zone (Manufacturer Set-up - Neutral zone configuration)

8.12.3 Water circuit temperature detection

Through installation of two temperature probes, **c-pro 3 kilo CLOSE** is able to detect the water circuit inlet and outlet water temperatures.

With parameter "**IN / Free cooling water temperature**" (Manufacturer set-up - Probe configuration) it is possible to configure the water detection probe on water circuit inlet.

With parameter "**OUT water temperature**" (Manufacturer set-up - Probe configuration) it is possible to configure the water detection probe on water circuit outlet.

8.12.4 WATER TEMPERATURE PROBES ALARMS MANAGEMENT

In the event the inlet water temperature probe should be broken or disconnected **c-pro 3 kilo CLOSE** will trigger the "**Broken IN / Free cooling water temperature probe alarm**".

In the event the outlet water temperature probe should be broken or disconnected **c-pro 3 kilo CLOSE** will trigger the "**Broken OUT water temperature probe alarm**".

8.13 Free cooling unit control

8.13.1 General information

With the "**Machine type configuration**" parameter (Manufacturer Set-up - Machine type configuration) it is possible to configure the type of temperature regulation with water or air free cooling system (**Free Cooling**).

The units with free cooling system use outdoor air to cool the room free of charge, when possible. Free cooling may be direct (outdoor air inflow) or indirect (through water circuit), in both cases the secondary circuit is always direct expansion with built-in air or water condenser.

8.13.2 Free cooling system control

The free cooling system is managed through temperature detection of outdoor or water flowing into the unit.

With parameter "**IN / Free cooling water temperature**" (Manufacturer set-up - Probe configuration) it is possible to configure the free cooling temperature detection probe.

Regulation will activate free cooling operation when the following function is valid:

$$T_{Reg} - T_{Fc} \geq \Delta_{Fc}$$

Where:

- **T_{Reg}** is the regulated temperature
- **T_{Fc}** is the free cooling temperature
- **Δ_{Fc}** is parameter "**Delta free cooling**" (User set-up - Free cooling & hybrid regulation)

When the free cooling system is active, temperature is regulated by regulating the damper or free cooling valve with 0-10 V control signal. The following pictures show the control diagram of the free cooling component with Proportional temperature regulation:

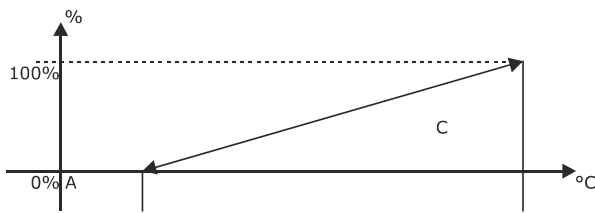

Where:

- A Temperature set-point (Main menu - Set-point)**
- B Proportional band (User set-up- Temperature regulation)**
- C Free cooling regulation**
- D Temperature neutral zone (Manufacturer Set-up - Neutral zone configuration)**

Should the free cooling system not be sufficient for temperature regulation, and the cooling request should reach 100%, *c-pro 3 kilo CLOSE* will activate the secondary circuit compressors. Compressor activation will be delayed in order to prevent unnecessary triggering.

After activating, the compressors will regulate the temperature as detailed in the previous chapters (direct expansion), while the free cooling signal will remain at 100%. After reaching the set-point the compressors will be stopped, while the free cooling valve will be overridden at 100% for a few seconds.

Should the outdoor temperature no longer be able to provide free cooling operation, and therefore the function should no longer be valid, the unit will only operate in direct expansion. See the previous chapters for further information.

8.13.3 Forzatura sistema free cooling

In order for the free cooling system to always be active, it is possible to set a digital input as free cooling system overriding input.

With the "**Configurable input (1-2-3-4)**" parameter (Manufacturer Set-up - Digital input configuration) it is possible to configure one of the four digital inputs in order to override free cooling operation, both always on and always off.

8.13.4 Free cooling temperature probe alarm management

In the event the free cooling temperature probe should be broken or disconnected *c-pro 3 kilo CLOSE* will trigger the "**Broken IN / Free cooling temperature probe alarm**".

This alarm stops free cooling operation and activates the cooling circuit components.

8.14 Dry cooler regulation

8.14.1 General information

In units with water circuit, and especially in units with free cooling system, it is possible to have speed regulation for a dry cooler fans (liquid cooler) to supply water to the unit.

With parameter "**IN / Free cooling water temperature**" (Manufacturer set-up - Probe configuration) it is possible to configure the water detection probe on water circuit inlet.

With parameter "**Dry cooler regulation**" (Manufacturer set-up - Dry cooler regulation configuration) it is possible to configure the type of regulation of the dry coolers connected to the unit. The following types of regulation can be selected:

- 1) No:** There is no type of dry cooler regulation in the unit, hence it will be disabled.
- 2) Proportional:** The dry coolers will be regulated with a proportional system through a 0-10 V signal.
- 3) Auto Set-point:** The dry coolers will be regulated with a proportional system through a 0-10 V signal. The regulation set-point will be calculated automatically based on operating conditions (see following chapters).

8.14.2 Dry cooler proportional regulation

The control output of the dry coolers is regulated according to the following function:

$$Out_p = \frac{100}{Bp} * (In - Set)$$

Where:

- **Bp** s the "Proportional dry cooler band" parameter (User set-up - Dry cooler regulation)
- **In** is the condensation temperature value
- **Set** is the "Dry cooler set-point " parameter (User set-up - Dry cooler regulation)

With the "**Minimum fan speed**" parameter (Manufacturer Set-up - Dry cooler regulation configuration) it is possible to configure the minimum operation speed of the dry cooler fans.

With the "**Maximum fan speed**" parameter (Manufacturer Set-up - Dry cooler regulation configuration) it is possible to configure the maximum operation speed of the dry cooler fans.

The following graph shows proportional regulation:

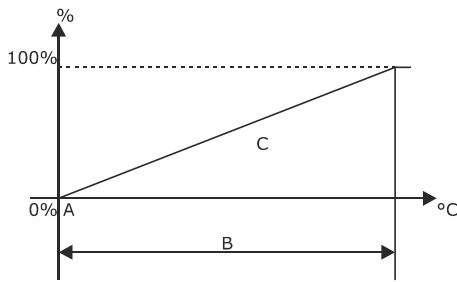

Where:

- A Dry cooler set-point (User set-up - Dry cooler regulation)**
- B Proportional dry cooler band (User set-up - Dry cooler regulation)**
- C Dry cooler regulation**

8.14.3 Dry cooler regulation with autosest-point

Through dry cooler regulation with **AutoSet-point** it is possible, with a suitable algorithm, to achieve the best possible regulation set-point for the water temperature.

For optimal AutoSet-point system regulation it is recommended to set parameter "**Dry cooler set-point**" (User set-up - Dry cooler regulation) at the minimum value at which one wishes the dry coolers to work (e.g. 7 °C).

The set-point is regulated in the following manner:

- **LOW OUTDOORS TEMPERATURE CONDITIONS:** As long as outdoor air temperature is such that water temperature remains within the zone defined by parameter "**Dry cooler set-point**" (User set-up - Dry cooler regulation) + parameter "**Dry cooler proportional band**" (User set-up - Dry cooler regulation), regulation type is proportional (see previous chapter).
- **INCREASE IN THE OUTDOOR TEMPERATURE:** Upon increase in outdoor air temperature, water temperature also starts increasing. Upon achieving 100% of the demand, a timer will be started. As soon as the timer exceeds parameter "**AutoSet-point time**" (Manufacturer set-up - Dry cooler regulation configuration), parameter "**Dry cooler set-point**" (User set-up - Dry cooler regulation) will be added to parameter "**Dry cooler set-point increase**" (User set-up - Dry cooler regulation). The set-point will be increased until the temperature falls within the new regulation range, up to the maximum equalling parameter "**Maximum dry cooler set-point**" (User set-up - Dry cooler regulation).
- **REGULATION WITH RAISED SET-POINT:** For as long as the set-point is increased, the fans speed will be forced to a minimum value equalling parameter "**Minimum AutoSet-point speed**" (Manufacturer set-up - Dry cooler regulation configuration). This stops the water temperature value from being affected if the set-point is reached.
- **DROP IN OUTDOOR TEMPERATURE:** With a drop in the outdoor air temperature, the water temperature tends to fall below the changed set-point. In this case, a timer will start as soon as the water temperature is outside of the regulation range. As soon as parameter "**AutoSet-point time**" is exceeded (Manufacturer set-up - Dry cooler regulation configuration), parameter "**Dry cooler Set-point increase**" (User set-up - Dry cooler regulation) will be subtracted from the modified set-point. The set-point will decrease until the water temperature falls within the regulation range, or until it reaches the parameter "**Set-point dry cooler**" (User setup - Dry cooler regulation).

8.14.4 Start-up request management

In order to improve dry cooler regulation it is possible to configure a start-up period. During the set start-up period regulation will be overridden at start-up speed. At the end of the start-up time regulation will go back to normal proportional operation.

With parameter "**Fans start-up speed**" (Manufacturer set-up - Dry cooler regulation configuration) it is possible to configure the speed at which the dry cooler fans will be regulated during the start-up period.

With the "**Fans start-up time**" parameter (Manufacturer Set-up - Dry cooler regulation configuration) it is possible to configure the duration of the dry cooler fans regulation start-up period.

This function is optimal to reach more quickly the work condition at the unit's start, with no need to wait for the modulation period required for reaching the set-point.

8.14.5 Dry cooler fans cut-off regulation

To avoid issues with water temperature over-regulation, it is possible to set a cut off value for dry cooler fans regulation.

With the "**Fans cut off**" parameter (Manufacturer Set-up - Dry cooler regulation configuration) it is possible to configure a cut-off temperature of the condensation fans. When water temperature reaches the set-point - cut-off, fans regulation will be stopped.

8.14.6 Dry cooler regulation management with broken water temperature probe

In order not to interrupt dry cooler regulation, in the event of breakdown of the IN water temperature probe it is possible to override the fans speed at a pre-set value.

With parameter "**Override with probe error**" (Manufacturer Set-up - Dry cooler regulation configuration) it is possible to configure the percentage at which the fans speed will be overridden with "**Broken IN /Free cooling water temperature probe alarm**".

8.14.7 Dry cooler alarms management

In order to detect any issues to do with the dry coolers, it is possible to configure a digital input as general dry cooler alarm.

With the "**Configurable input (1-2-3-4)**" parameter (Manufacturer Set-up - Digital input configuration) it is possible to configure one of the four digital inputs in order to detect the general dry cooler alarm.

When configured, digital input opening will trigger the "**General dry cooler alarm**" which will stop dry cooler regulation.

Al fine di rilevare eventuali problematiche legate ai dry cooler, è possibile configurare un ingresso digitale come allarme generale dry cooler.

8.15 Water pump management

8.15.1 General information

c-pro 3 kilo CLOSE is able to control activation of a water circulation pump feeding the unit's circuits.

8.15.2 Water pump management configuration

With parameter "**Pump regulation type**" (Manufacturer set-up - Water pump configuration) it is possible to configure the type of pump activation. The following types of regulation can be selected:

- 1) **No:** There is no type of water pump regulation in the unit, hence it will be disabled.
- 2) **Unit ON:** The pump will be activated at the same time as the unit's ON.
- 3) **Cooling request:** The pump will be activated only in case of cooling request.

With the "**Configurable output (1-2-3-4)**" parameter (Manufacturer Set-up - Digital output configuration) it is possible to configure one of the four digital outputs in order to control the water pump.

8.15.3 Water pump switch off delay management

In some cases the water pump might need to operate for a few seconds after the switch off request.

With parameter "**Pump switch off delay**" (Manufacturer Set-up - Water pump configuration) it is possible to configure a pump switch-off delay.

8.15.4 Water pump alarm management

In order to supply the unit with information on the water pump's status, it is possible to configure a digital input as general water pump alarm.

With the "**Configurable input (1-2-3-4)**" parameter (Manufacturer Set-up - Digital input configuration) it is possible to configure one of the four digital inputs in order to detect the water pump alarm.

When configured, digital input opening will trigger the "**General water pump alarm**" which will stop water pump regulation.

Depending on the setting of parameter "**Water pump alarms severity**" (Manufacturer Set-up - Alarm management configuration), triggering the alarm may also stop the unit.

8.16 Hybrid units regulation

8.16.1 General information

With the "**Machine type configuration**" parameter (Manufacturer Set-up - Machine type configuration) it is possible to configure the type of temperature regulation with water or direct expansion hybrid system.

Units with hybrid system have two separate cooling sources inside, a primary one for normal regulation and a secondary emergency one in case of any problems with the primary source.

With parameter "**Primary source selection**" (Manufacturer Set-up - Machine type configuration) it is possible to configure the type of primary cooling choosing between Chilled water and Direct expansion.

With parameter "**Secondary source selection**" (Manufacturer Set-up - Machine type configuration) it is possible to configure the type of secondary cooling choosing between Chilled water and Direct expansion.

8.16.2 Water hybrid system regulation

The hybrid system with chilled water primary cooling source is controlled by detecting water temperature on primary circuit inlet.

With parameter "**IN / Free cooling water temperature**" (Manufacturer set-up - Probe configuration) it is possible to configure the water temperature detection probe on primary circuit inlet.

c-pro 3 kilo CLOSE will use the primary source for temperature regulation, for as long as the inlet water temperature remains below parameter "**Water set-point hybrid**" (User set-up - Free cooling & hybrid regulation) + parameter "Water band hybrid" (User set-up - Free cooling & hybrid regulation).

Should inlet water temperature be higher than parameter "Hybrid units water set-point" (User set-up - Free cooling & hybrid regulation) + parameter "Hybrid units water band" (User set-up - Free cooling & hybrid regulation), c-pro 3 kilo CLOSE will stop the primary source and switch to the secondary one.

Switching back to the primary source will take place when water temperature is again the same as parameter "Hybrid units water setpoint" (User set-up - Free cooling & hybrid regulation).

8.16.3 Direct expansion hybrid system regulation

The hybrid system with direct expansion primary cooling source is managed by detecting the alarms of the primary direct expansion circuit.

c-pro 3 kilo CLOSE will use the primary source for temperature regulation, for as long as there are no alarms that affect cooling circuit operation.

Should the cooling circuit no longer be operative, c-pro 3 kilo CLOSE will stop the primary source to switch to the secondary one. The secondary source will remain active until the cooling circuit conditions have been restored.

8.16.4 Secondary cooling source overriding

With parameter "Hybrid units source exchange" (User set-up - Free cooling & two sources regulation) it is possible to override secondary source operation.

In order to speed up the switch to the secondary cooling source, or in the event of maintenance, it is also possible to set a digital input as forced source exchange input.

With the "Configurable input (1-2-3-4)" parameter (Manufacturer Set-up - Digital input configuration) it is possible to configure one of the four digital inputs in order to override operation with secondary source.

8.17 Heating components regulaiton

8.17.1 General information

With parameter "heating" (Manufacturer set-up - Heating configuration) it is possible to configure the type of temperature regulation during winter heating and summer post-heating (dehumidification). The following types of regulation can be selected:

- 1) **No:** There is no type of heating regulation in the unit, hence it will be disabled.
- 2) **Stage resistors:** The unit is fitted with a stage electric heater, which is controlled by the relevant digital outputs.
- 3) **Modulating coil:** The unit is fitted with a modulating electric heater, which is controlled by a 0-10 V signal.
- 4) **Water valve:** The unit is fitted with a water heating coil, which is controlled by a 0-10 V signal.

8.17.2 Heating with stage electric heaters

c-pro 3 kilo CLOSE is able to control electrical stage coils with up to 2 stages. The following pictures show the start-up diagram of the stages with Proportional temperature regulation:

With parameter "Number of electric heater stages" (Manufacturer set-up - Heating configuration) it is possible to configure the number of stages the unit's electric heater consists of (Maximum 2).

With parameter "Type of stage activation" (Manufacturer set-up - Heating configuration) it is possible to configure the type of stage switching on choosing between 2 and 3 Steps. See the following graphs for further information.

With parameter "Electric heater power" (Manufacturer set-up - Heating configuration) it is possible to configure the electrical power of the installed coils.

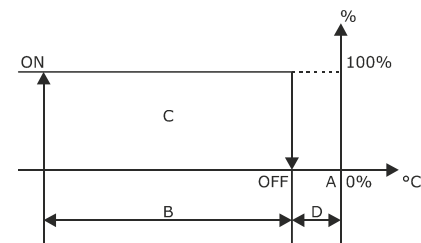

Regulation with 1 stage

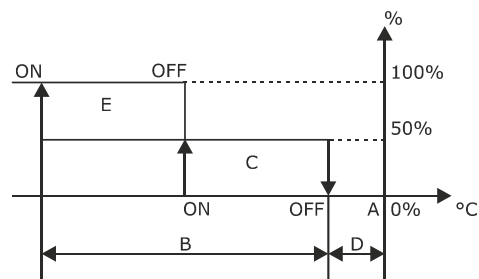

Regulation with 2 stages (2 steps)

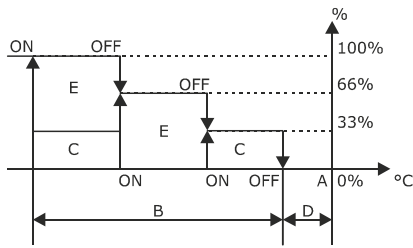

- A Temperature set-point (Mainmenu - Set-point)**
- B Proportional band (User set-up- Temperature regulation)**
- C Stage 1**
- D Temperature neutral zone (Manufacturer Set-up - Neutral zone configuration)**
- E Stage 2**

Regulation with 2 stages (3 steps)

8.17.3 Heating with electrical or water modulating coils

c-pro 3 kilo CLOSE is able to manage electrical or water modulating coils via 0-10 V signal. The following pictures show the modulation diagram with Proportional temperature regulation:

With parameter "Electric heater power" (Manufacturer set-up - Heating configuration) it is possible to configure the electrical power of

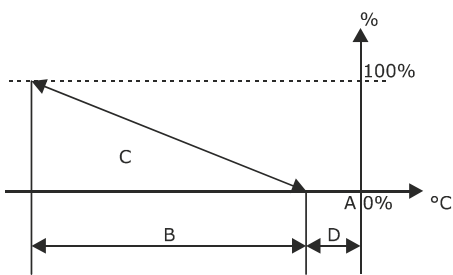

- A Temperature set-point (Main menu - Set-point)**
- B Proportional band (User set-up- Temperature regulation)**
- C Heating**
- D Temperature neutral zone (Manufacturer Set-up - neutral zone configuration)**

8.17.4 Electric heater alarms management

The electric heaters provide active protection against overheating, through the installation of a safety thermostat placed inside the electric heater.

Should the safety thermostat detect a temperature exceeding 135 °C, it will stop its operation. Opening the alarm digital input will trigger the "Electric heater safety thermostat alarm" which will stop heating regulation. The thermostat is manually reset. therefore it will need to be reset to clear the alarm.

8.18 Configurable digital inputs

8.18.1 General information

c-pro 3 kilo CLOSE is able to control up to four digital inputs freely configurable by the user.

With the "**Configurable input (1-2-3-4)**" parameter (Manufacturer Set-up - Digital input configuration) it is possible to configure one of the four digital inputs according to system requirements.

With parameter "**Configurable input logic (1-2-3-4)**" (Manufacturer Set-up - Digital input configuration) it is possible to configure the input wiring logic choosing between **N.C. - Normally closed** and **N.O. - Normally open**.

8.18.2 Configurable digital inputs management

With parameter "**Configurable input (1-2-3-4)**" (Manufacturer Set-up - Digital input configuration) it is possible to configure one of the following types of control:

TYPES OF CONFIGURABLE DIGITAL INPUTS	
CONTROL	SOFTWARE REACTION
Fire/Smoke Alarm	Unit OFF
General water pump alarm	Pump and cooling OFF
External humidifier general alarm	Humidification OFF
General supply fans alarm	Unit OFF
Condenser 1 general alarm	Condenser 1 OFF and compressor 1 OFF
Condenser 2 general alarm	Condenser 2 OFF and compressor 2 OFF
Dry cooler general alarm	Dry cooler OFF and cooling OFF
Condensing unit generic alarm	Cooling OFF
Non-critical generic alarm	Alarm only
Critical generic alarm	Unit OFF
STOP Cooling	Cooling OFF
STOP Heating	Heating OFF
STOP Humidification	Humidification OFF
STOP Dehumidification	Dehumidification OFF
STOP Heating and humidification	Heating OFF and humidification OFF
STOP Cooling, heating and humidification	Cooling, heating and humidification OFF
STOP Free cooling	Free cooling OFF
Free cooling override	Free cooling ON
Hybrid units 2nd Source override	Hybrid units 2nd Source ON

8.19 Configurable digital outputs

8.19.1 General information

c-pro 3 kilo CLOSE is able to control up to four digital outputs freely configurable by the user.

With the "**Configurable output (1-2-3-4)**" parameter (Manufacturer Set-up - Digital output configuration) it is possible to configure one of the four digital outputs according to system requirements.

With parameter "**Configurable output logic (1-2-3-4)**" (Manufacturer Set-up - Digital output configuration) it is possible to configure the output operation logic choosing between **N.C. - Normally closed** and **N.O. - Normally open**.

8.19.2 Configurable digital outputs management

With parameter "**Configurable output (1-2-3-4)**" (Manufacturer Set-up - Digital input configuration) it is possible to configure one of the following types of control:

TYPES OF CONFIGURABLE DIGITAL OUTPUTS

Water pump control

Condensing unit control

Unit status signal

Cooling status signal

Heating status signal

Humidification status signal

Dehumidification status signal

Free cooling status signal

General alarm signal

Non-critical alarm signal

Critical alarm signal

Dirty filters alarm signal

Cooling alarm signal

Heating alarm signal

Fans alarm signal

Temperature alarm signal

Humidity alarm signal

Flooding / Condensate drain alarm signal

8.20 Internal components alarms management

8.20.1 Air filter alarm management

If **c-pro 3 kilo CLOSE** is able to control an air filter alarm, to signal the presence of dirty filters.

Should a filter be dirty, the suitable pressure sensor will act on the digital dirty filters alarm input. **c-pro 3 kilo CLOSE** will trigger the **"Clogged air filters alarm"**. The air filters alarm does not stop normal unit operation.

8.20.2 Water presence/ condensate drain pump alarm management

If **c-pro 3 kilo CLOSE** is able to control a water presence alarm, to signal the presence of water in the unit. The water alarm is controlled by a detector fitted with water presence probe, to be installed by the user. If the condensate drain pump is present, the pump alarm will be inserted in series to the water detector alarm.

Should water presence or a pump alarm be detected, **c-pro 3 kilo CLOSE** will trigger the **"Water presence/Condensate drain pump alarm"**.

Depending on the setting of parameter **"Water presence alarms severity"** (Manufacturer Set-up - Alarm management configuration), triggering the alarm may also stop the unit.

8.20.3 Smoke/fire alarm management

If **c-pro 3 kilo CLOSE** is able to control a smoke or fire presence alarm, to switch off the unit.

With the **"Configurable input (1-2-3-4)"** parameter (Manufacturer Set-up - Digital input configuration) it is possible to configure one of the four digital inputs to control the smoke/fire alarm.

By acting on the alarm digital input, **c-pro 3 kilo CLOSE** will trigger the **"Smoke/fire presence alarm"** which stops normal unit operation.

According to the setting of parameter **"Smoke/fire alarm reset type"** (Manufacturer set-up - Alarms management configuration), it is possible to select the type of alarm reset choosing between Manual or Automatic.

8.20.4 Non critical and critical generic alarm management

If **c-pro 3 kilo CLOSE** is able to control a generic non-critical or critical alarm, which may be intended for the user for different purposes.

With the **"Configurable input (1-2-3-4)"** parameter (Manufacturer Set-up - Digital input configuration) it is possible to configure one of the four digital inputs to control the generic non-critical or critical alarm.

By acting on the digital alarm input, **c-pro 3 kilo CLOSE** will trigger the **"Non-critical generic alarm"** or the **"Critical generic alarm"**. The non-critical generic alarm does not stop normal unit operation. The critical generic alarm stops normal unit operation.

8.21 Probe calibration management

The value of the probes installed inside the unit might need to be changed depending on system requirements. To this end **c-pro 3 kilo CLOSE** is able to manage a probe calibration value to be added to the actual reading.

With parameter **"Return temperature"** (User set-up - Probe calibration) it is possible to calibrate the return temperature probe.

With parameter **"Supply temperature"** (User set-up - Probe calibration) it is possible to calibrate the supply temperature probe.

With parameter **"Humidity"** (User set-up - Probe calibration) it is possible to calibrate the humidity probe.

With the **"Differential air pressure"** parameter (User Set-up - Probe calibration) it is possible to calibrate the air differential pressure sensor.

With parameter **"IN / Free cooling water temperature"** (User set-up - Probe calibration) it is possible to calibrate the water inlet / free cooling temperature probe.

With parameter **"OUT water temperature"** (User set-up - Probe calibration) it is possible to calibrate the water outlet temperature probe.

8.22 MODBUS RTU slave serial communication management

c-pro 3 kilo CLOSE regulator is fitted with a serial RS485 output for connection to supervision/BMS systems, via MODBUS RTU slave protocol. See the following chapters for further information.

With parameter **"MODBUS address"** (User set-up - Supervision) it is possible to set the unit's serial address for interfacing with the MODBUS network.

With parameter **"MODBUS Baudrate"** (User set-up - Supervision) it is possible to set the unit's communication speed for interfacing with the MODBUS network.

8.23 Changing access passwords

The parameter management menus are password protected. These passwords may be changed according to the user's requirements. If modified, the original passwords will no longer be valid.

With parameter "**User password**" (User set-up - Password) it is possible to change the password to access the User menu.

With parameter "**Manufacturer password**" (Manufacturer set-up - Password) it is possible to change the password to access the **Manufacturer** menu.

8.24 Clearing the alarm log and operating hours

8.24.1 Clearing the alarm log

During unit maintenance operations it might be required to clear the alarm log stored in the **c-pro 3 kilo CLOSE**.

With parameter "**Clear alarm log**" (Log clearing - Alarm log) it is possible to delete the stored alarms log.

Access to alarms log clearing is only possible with a **Manufacturer** log in.

8.24.2 Clearing operating hours

During unit maintenance operations it might be required to clear the operating hours of the main components, stored in the **c-pro 3 kilo CLOSE**.

With parameter "**Unit hours**" (Log clearing - Operating hours) it is possible to delete the unit's operating hours.

With parameter "**Compressor 1**" (Log clearing - Operating hours) it is possible to delete compressor 1 operating hours.

With parameter "**Compressor 2**" (Log clearing - Operating hours) it is possible to delete compressor 2 operating hours.

With parameter "**Water valve**" (Log clearing - Operating hours) it is possible to delete water valve operating hours.

With parameter "**Electric resistors**" (Log clearing - Operating hours) it is possible to delete electric resistors operating hours.

With parameter "**Humidifier**" (Log clearing - Operating hours) it is possible to delete the humidifier's operating hours. In case of internal humidifier operating hours on the CPY board will also be cleared.

With parameter "**Free cooling**" (Log clearing - Operating hours) it is possible to delete free cooling operating hours.

With parameter "**Dry cooler**" (Log clearing - Operating hours) it is possible to delete dry cooler operating hours.

With parameter "**Condenser 1**" (Log clearing - Operating hours) it is possible to delete condenser 1 operating hours.

With parameter "**Condenser 2**" (Log clearing - Operating hours) it is possible to delete condenser 2 operating hours.

Access to alarms log clearing is only possible with a **Manufacturer** log in.

9 COMPONENT CONTROL MODBUS MASTER NETWORK

9.1 General information

c-pro 3 kilo CLOSE microprocessors use a MODBUS master network to control the devices installed in the unit. The following devices are interfaced with the MODBUS master network:

- EC air supply fans.
- EVDrive electronic expansion valve control boards.

The MODBUS master control network is implemented during unit assembly in the production line (see wiring diagram for additional details):

9.2 MODBUS master network device routing

The components connected to the MODBUS master network are routed in the testing stage in the factory.

In the event of replacement the components will be sent already configured for connection to the MODBUS master network. Only fans will be sent not pre-configured. Fans routing configuration will take place through a self-routing function.

The following table sets out the addresses of individual components that might be included in the MODBUS master network:

MODBUS MASTER NETWORK ROUTING	
DEVICE	ADDRESS
EVDrive compressor 1	2
EVDrive compressor 2	3
Fan 1	6
Fan 2	7
Fan 3	8
Fan 4	9
Fan 5	10

9.2.1 Fans self-routing in case of replacement

In the event of fans replacement, the **c-pro 3 kilo CLOSE** microprocessor features a check and self-routing function of the MODBUS master network.

In the event of a communication alarm of one or more fans the **c-pro 3 kilo CLOSE** microprocessor will start checking whether there are new fans in the network.

If the **c-pro 3 kilo CLOSE** microprocessor finds a non configured fan (new) in the network, it will change the address to that of the faulty one. Should there be several fans in alarm the fan will be given the first free address.



During the self-routing process the NEW FANS will have to be connected ONE AT A TIME.

10 UNIT CONTROL CANBUS NETWORK

10.1 General information

c-pro 3 kilo CLOSE is able to control up to twelve connected units that form a local network. The local network allows information to be exchanged between the units that will be able to work in synchrony to control the conditioned premises, also assuring a higher safety level by sharing the thermal load.

Network management is **Multi-Master** type, i.e. there is no unit that sets the others' actions. All the units in the network have the task to monitor the general condition, acting in synchrony in the required regulation.

10.2 Addressing unit in the local network

All the units connected in local network must have a unique address that identifies them within the network. With parameter "**Network address**" (Manufacturer set-up - Local network configuration) it is possible to select the unit's network address, according to the following logic:

NETWORK ROUTING				
UNIT ADDRESS	TYPE	ID	DISPLAY ID	REMOTE DISPLAY ID
13	Stand alone	13	99	
1	Unit 1	1	101	
2	Unit 2	2	102	
3	Unit 3	3	103	
4	Unit 4	4	104	
5	Unit 5	5	105	
6	Unit 6	6	106	126
7	Unit 7	7	107	
8	Unit 8	8	108	
9	Unit 9	9	109	
10	Unit 10	10	110	
11	Unit 11	11	111	
12	Unit 12	12	112	



The network address may only be modified with the *c-pro 3 kilo CLOSE* not connected to other units. Should the units be connected the network cables must first be disconnected. For more details on network connection refer to the wiring diagram and the units' installation manual

10.3 Local network types

With parameter "**Network operation**" (Manufacturer set-up - Local network configuration) it is possible to select the type of local network one wishes to control.

10.4 Local network regulation

10.4.1 General information

The main feature of the local network is that a part of the units are operating (Duty) and a part of the units are in stand-by awaiting to start up in case of need (Stand-by).

With parameter "**Number of networked units**" (Manufacturer set-up - Local network configuration) it is possible to select the total number of units in the local network.

With parameter "**Number of stand-by units**" (Manufacturer set-up - Local network configuration) it is possible to select the number of units that will remain off in stand-by. It is not possible to set all units in stand-by, at least one unit will always be operating.

10.4.2 AUTOMATIC UNIT ROTATION

In order to balance the units' operating hours, in Duty/Stand-by operation it is possible to set an automatic rotation function to switch the units' role.

With parameter "**Enable unit rotation**" (Manufacturer set-up - Local network configuration) it is possible to enable the unit's role rotation.

With parameter "**Rotation interval**" (Manufacturer set-up - Local network configuration) it is possible to set the time interval between role rotations.

10.4.3 Stand-by unit activation in case of alarm

The purpose of Stand-by units is that of being switched on to replace operating units in the event of a critical problem.

To this end, in the event one of the two operating units should be stopped due to a critical alarm, one of the Stand-by units will be switched on to make up for the lack.

Should there be several Stand-by units, the unit with the least number of operating hours will be switched on. Should the units have the same number of operating hours, the unit with the lowest network address will be switched on.

10.4.4 Management of the temperature regulation support system

In Network operation it is possible to set a temperature regulation support control function.

With parameter "**Enable support**" (Manufacturer set-up - Local network configuration) it is possible to enable support switch-on of stand-by units.

With parameter "**Support switch on time**" (Manufacturer set-up - Local network configuration) it is possible to set the time interval for supporting units switch-on.

Should the regulated temperature in one or more operating units exceed the proportional band limit, the Stand-by units will be switched on in sequence so the temperature goes back to the set-point. Switching on will occur after the set switch-on time.

Should there be several Stand-by units, the unit with the least number of operating hours will be switched on. Should the units have the same number of operating hours, the unit with the lowest network address will be switched on.

The switched on units will regulate the temperature according to their settings, regardless of the operating units that have required switching on. In order to improve regulation it is possible to use the operation described in the following chapters.

Upon reaching the set-point the units will be stopped and go back to Stand-by.

10.5 Switching on system with dynamic On/Off

10.5.1 General information

All units in local network may be switched on or off individually as is the case with stand-alone units. In order to reduce switching on times of the entire local network it is possible to choose whether to switch on or off all the units simultaneously.

With parameter "**Dynamic On/Off**" (Manufacturer set-up - Local network configuration) it is possible to enable simultaneous switching on and off of all networked units.

The Dynamic On/Off function is especially suited for local Duty/Stand-by networks to prevent any errors in switching on stand-by units.

10.5.2 Unit network entry

If the Dynamic On/Off system is not present, when one or more units enter the network components regulation will be subject to a reset to prevent misalignment issues.

Therefore the fans will go back to minimum or start speed (only for constant pressure regulation), while the temperature regulation will be recalculated if a proportional + integral + derivative system is set.

10.6 Dynamic set-point system

In all local network units, the temperature set-point may be individually changed as is the case for stand-alone units. In the event all units need to regulate with the same set-point, it is possible to activate the dynamic set-point function which allows setpoints to be changed simultaneously in all networked units.

With parameter "**Dynamic Set-point**" (Manufacturer set-up - Local network configuration) it is possible to enable simultaneous set-point change in all networked units.

The dynamic set-point function is especially suitable to prevent incorrect network set-point settings which might create regulation conflicts.

10.7 Air temperature, humidity and pressure average control system

Local network units are usually used to manage a single room. In these cases it is possible to set a regulation control system by using average values detected by the networked units.

Using the average function makes it possible to obtain consistent components regulation of individual units, which will be activated simultaneously on all networked units.

This function also makes it possible to prevent regulation conflict issues, where two or more units regulate in the opposite way, for instance one heats and the other cools at the same time.

With parameter "**Temperature average**" (Manufacturer set-up - Local network configuration) it is possible to enable the average calculation of temperatures detected by the unit, in relation to temperature regulation.

With parameter "**Humidity average**" (Manufacturer set-up - Local network configuration) it is possible to enable the average calculation of humidity detected by the unit, in relation to humidity regulation.

With parameter "**Ambient pressure average**" (Manufacturer set-up - Local network configuration) it is possible to enable the average calculation of ambient pressures detected by the unit, in relation to constant air pressure regulation.

10.7.1 Exclusion from average calculation

In order to prevent issues in average calculation, it will exclude automatically the units that are:

- **OFF:** Units set to OFF will be automatically excluded from average calculation.
- **In Stand-by:** Units in stand-by will actively participate in average calculation only when they are active in replacement or support
- **In critical alarm:** Units in OFF FROM ALARM will be automatically excluded from average calculation.
- **With probes in alarm:** Units that have broken probes will be automatically excluded from average calculation in relation to the probe in alarm.

Upon restoring the unit's normal operative conditions, it will automatically be included again in average calculation.

10.8 Failed local network communication alarm management

The units constantly monitor the local network communication status. Should there be a problem and communication should remain down for longer than 30 s, *c-pro 3 kilo CLOSE* will trigger the "**Local network communication alarm**".

In the event of alarm the unit will continue operating regularly as if it were in stand-alone, without interrupting component regulation at all.

When connection is restored the alarm is automatically reset and the unit starts regulating again according to the type of local network.











11 CONTROL SOFTWARE PARAMETERS AND THEIR MODIFICATION

11.1 Access to password protected menus



To access the parameters for the PROTECTED MENUS it is necessary to enter in the PARAMETERS MENU, the correct LOGIN password:

- USER PARAMETERS: Default password 0123 (Modifiable)
- MANUFACTURER PARAMETERS: Default password 0694 (Modifiable)



11.1.1 Login password entry

- Select the **LOGIN MENU** with the **UP** () and **DOWN** () keys and press **ENTER** () to access the menu
- It is possible to select individual digits of the password with the **UP** () and **DOWN** () keys
- To change the digit press **ENTER** (); when it is selected, the digit starts blinking
- Use the **UP** () and **DOWN** () key to change the password digit
- To memorise the entered value, simply press **ENTER** ()
- However, should you not wish to save the parameter, just press **ESC** ()







11.2 ACCESS TO REGULATION PARAMETER MENUS

- Select the **MENU** you wish to access with the **UP** () and **DOWN** () keys and press **ENTER** () to access the **MENU**

The **PARAMETERS MENUS** are divided into several **GROUPS**, whose name describes the function of the parameters it contains.

To access change of the PARAMETERS of each group, just select the GROUP you wish to access with the **UP** () and **DOWN** () keys and press **ENTER** () to access the **GROUP**.

11.3 Modifying the control parameters

- Select the **PARAMETER** you wish to change with the **UP** () and **DOWN** () keys
- To change the parameter press **ENTER** (); when it is selected, the parameter starts blinking
- Use the **UP** () and **DOWN** () key to change the parameter
- To memorise the entered value, simply press **ENTER** ().
- However, should you not wish to save the parameter, just press **ESC** ().

11.4 Exiting the groups, menus and main menu

- It is possible to exit the **GROUPS**, the **MENUS** and the **MAIN MENU** by pressing the **ESC** () key.

12 CONFIGURATION PARAMETERS LIST

The following tables shows the meaning of the device's configuration parameters.

12.1 Set-point Menu: set-point modification

PARAM.	DEFAULT	MIN.	MAX.	U.M.	SETPOINT
SP1	22,0	SL1	SL2	°C/°F (1)	Temperature set-point
SP2	50	SL3	SL4	%Rh	Humidity set-point

12.2 User setup: setting the operating program

PARAM.	DEFAULT	MIN.	MAX.	U.M.	LANGUAGE
LNG	Italian			- - - -	0=Italian, 1=English
PARAM.	DEFAULT	MIN.	MAX.	U.M.	VENTILATION SET-POINT
VS1	2.200	500	99000	m ³ /h	Air flow rate set-point
VS2	20	-900	900	Pa	Air pressure set-point
PARAM.	DEFAULT	MIN.	MAX.	U.M.	TEMPERATURE REGULATION
TR1	0	0	1	- - - -	Regulation sensor 0= Return 1=Supply
TR2	0	0	2	- - - -	Regulation type 0= P 1= PI 2= PID
TR3	2,0	0,1	60	°C/°F (1)	Proportional band
TR4	0	0	9999	s	Integration time
TR5	0	0	9999	s	Derivation type
TR6	10,0	0,0	20,0	°C/°F (1)	High temperature alarm offset
TR7	10,0	0,0	20,0	°C/°F (1)	Low temperature alarm offset
PARAM.	DEFAULT	MIN.	MAX.	U.M.	LIMIT TEMPERATURE REGULATION
LT1	30,0	-15,0	90,0	°C/°F (1)	Temperature upper limit

LT2	8,0	-15,0	90,0	°C/°F (1)	Temperature lower limit
PARAM.	DEFAULT	MIN.	MAX.	U.M.	HUMIDITY REGULATION
HR1	10	1	50	%Rh	Dehumidification proportional band
HR2	10	1	50	%Rh	Humidification proportional band
HR3	20	0	100	%Rh	High return humidity alarm offset
HR4	20	0	100	%Rh	Low return humidity alarm offset
PARAM.	DEFAULT	MIN.	MAX.	U.M.	HUMIDIFIER REGULATION
HM1	1	0	1	----	Humidification enabling 0= No 1= Yes
PARAM.	DEFAULT	MIN.	MAX.	U.M.	FREE COOLING AND HYBRID UNITS REGULATION
FC1	4,0	1,0	30,0	°C/°F (1)	Free cooling delta
UI1	7,0	1,0	30,0	°C/°F (1)	Hybrid units water set-point
UI2	0,5	0,1	20,0	°C/°F (1)	Hybrid units water band
UI3	0	0	1	----	Hybrid units source exchange 0= No 1=Yes
PARAM.	DEFAULT	MIN.	MAX.	U.M.	CONDENSER REGULATION
CR1	45,0	30,0	65,0	°C/°F (1)	Condensation set-point
CR2	5,0	1,0	40,0	°C/°F (1)	Condensation proportional band
CR3	1,0	0,1	50,0	°C/°F (1)	Condensation set-point increase
CR4	55,0	0,1	65,0	°C/°F (1)	Maximum condensation set-point
PARAM.	DEFAULT	MIN.	MAX.	U.M.	DRY COOLER REGULATION
DC1	10,0	1,0	65,0	°C/°F (1)	Dry cooler set-point
DC2	5,0	0,5	20,0	°C/°F (1)	Dry cooler proportional band
DC3	1,0	0,1	50,0	°C/°F (1)	Dry cooler set-point increase
DC4	50,0	0,1	65,0	°C/°F (1)	Maximum dry-cooler set-point

PARAM.	DEFAULT	MIN.	MAX.	U.M.	PROBE CALIBRATION
PO1	0,0	-10,0	10,0	°C/°F (1)	Return temperature
PO2	0,0	-10,0	10,0	°C/°F (1)	Supply temperature
PO3	0	-10	10	%Rh	Return humidity
PO4	0	-100	100	Pa	Air differential pressure
PO5	0,0	-10,0	10,0	°C/°F (1)	IN / Free cooling water temperature
PARAM.	DEFAULT	MIN.	MAX.	U.M.	EXTERNAL SUPERVISOR
SU1	1	1	254	- - - -	MODBUS address
SU2	4	0	7	Baud	MODBUS baudrate 0= 1200 1= 2400 2= 4800 3= 9600 4= 19200 5= 28800 6= 38400 7= 57600
PARAM.	DEFAULT	MIN.	MAX.	U.M.	PASSWORD
UPW	1	0	9999	- - - -	User password

12.3 Manufacturer setup loop: configuration of the components

PARAM.	DEFAULT	MIN.	MAX.	U.M.	PROBE CONFIGURATION
PR1	0	0	1	- - - -	Air differential pressure 0= No 1= Yes
PR2	0	0	1	- - - -	Humidity 0= No 1= Yes
PR3	0	0	1	- - - -	Return air temperature 0= No 1= Yes

PR4	0	0	1	----	Supply air temperature 0= No 1= Yes
PR5	0	0	1	----	IN / Free cooling temperature 0= No 1= Yes
PR6	0	0	1	----	Compressor 1 discharge temperature (only if present on c-pro 3) 0= No 1= Yes
PR7	0	0	1	----	Compressor 1 condensation pressure (only if present on c-pro 3) 0= No 1= Yes
PR8	0	0	1	----	Compressor 2 discharge temperature (only if present on c-pro 3) 0= No 1= Yes
PR9	0	0	1	----	Compressor 2 condensation pressure (only if present on c-pro 3) 0= No 1= Yes
PARAM.	DEFAULT	MIN.	MAX.	U.M.	DIGITAL INPUT CONFIGURATION
DI1	0	0	29	----	Configurable input 1 0=No 1=Damper status 2=Dirty filters 3= Remote OFF 4=Flooding alarm 5=Smoke/Fire 6=Water pump alarm 7=External humidifier alarm 8=Fans general alarm 9=Condenser 1 alarm 10=Condenser 2 alarm 11=Dry Cooler alarm 12=Condensing unit alarm 13=Electric heater general alarm 14=Water flow alarm 15= Cmp1 thermal alarm 16= Cmp2 thermal alarm 17= Cmp1 high pressure alarm 18= Cmp2 high pressure alarm 19= Cmp1 low pressure alarm 20= Cmp 2 low pressure alarm 21=STOP cooling 22=STOP heating 23=STOP humidifying 24=STOP deumidifica 25=STOP heating+humidifying

					26=STOP cooling+heating+humidifying 27=STOP free cooling 28=FORCE free cooling 29=FORCE hybrid units
DL1	0	0	1	----	Configurable input 1 logic 0= N.O. 1= N.C.
DI2	0	0	29	----	Configurable input 2 • To choose the parameter value, refer to "Configurable Input 1" list
DL2	0	0	1	----	Configurable input 2 logic 0= N.O. 1= N.C.
DI3	0	0	29	----	Configurable input 3 • To choose the parameter value, refer to "Configurable Input 1" list"
DL3	0	0	1	----	Configurable input 3 logic 0= N.O. 1= N.C.
DI4	0	0	29	----	Configurable input 4 • To choose the parameter value, refer to "Configurable Input 1" list
DL4	0	0	1	----	Configurable input 4 logic 0= N.O. 1= N.C.
DI5	0	0	29	----	Configurable input 5 • To choose the parameter value, refer to "Configurable Input 1" list
DL5	0	0	1	----	Configurable input 5 logic 0= N.O. 1= N.C.
DI6	0	0	29	----	Configurable input 6 • To choose the parameter value, refer to "Configurable Input 1" list
DL6	0	0	1	----	Configurable input 6 logic 0= N.O. 1= N.C.

DI7	0	0	29	----	Configurable input 7 <ul style="list-style-type: none"> To choose the parameter value, refer to "Configurable Input 1" list
DL7	0	0	1	----	Configurable input 7 logic 0= N.O. 1= N.C.
DI8	0	0	29	----	Configurable input 8 <ul style="list-style-type: none"> To choose the parameter value, refer to "Configurable Input 1" list
DL8	0	0	1	----	Configurable input 8 logic 0= N.O. 1= N.C.
DI9	0	0	29	----	Configurable input 9 <ul style="list-style-type: none"> To choose the parameter value, refer to "Configurable Input 1" list
DL9	0	0	1	----	Configurable input 9 logic 0= N.O. 1= N.C.
DL10	0	0	1	----	Compressor thermal protection EV input logic 0= N.O. 1= N.C.
DL11	0	0	1	----	Compressor high pressure EV input logic 0= N.O. 1= N.C.
DL12	0	0	1	----	Compressor low pressure EV input logic 0= N.O. 1= N.C.
PARAM.	DEFAULT	MIN.	MAX.	U.M.	DIGITAL OUTPUT CONFIGURATION
DO1	0	0	11	----	Configurable output 1 0= No 1= Compressor 1 control 2= Compressor 2 control 3= Water pump control 4= Condensing unit control 5=Unit status 6=Cooling status 7=Heating status 8=Humidification status 9=De-humidification status 10= Free cooling status 11= General alarm

DL1	0	0	1	-----	Configurable output 1 logic 0= N.O. 1= N.C.
DO2	0	0	11	-----	Configurable output 2 • To choose the parameter value, refer to "Configurable Output 1" list
DL2	0	0	1	-----	Configurable output 2 logic 0= N.O. 1= N.C.
DO3	0	0	11	-----	Configurable output 3 • To choose the parameter value, refer to "Configurable Output 1" list
DL3	0	0	1	-----	Configurable output 3 logic 0= N.O. 1= N.C.
DO4	0	0	11	-----	Configurable output 4 • To choose the parameter value, refer to "Configurable Output 1" list
DL4	0	0	1	-----	Configurable output 4 logic 0= N.O. 1= N.C.
DO5	0	0	11	-----	Configurable output 5 • To choose the parameter value, refer to "Configurable Output 1" list
DL5	0	0	1	-----	Configurable output 5 logic 0= N.O. 1= N.C.
PARAM.	DEFAULT	MIN.	MAX.	U.M.	VENTILATION CONFIGURATION
VE1	1	1	5	-----	Number of fans
VE2	2	0	3	-----	Type of fans 0= On-Off 1= Analogue 2= MODBUS EBM 3= MODBUS ZIEHL

VE3	1	0	3	- - - -	Regulation type 0= Fixed speed 1= Cooling/heating regulation 2= Constant flow 3= Constant pressure
VE4	100	10	100	%	Maximum fan speed
VE5	40	10	100	%	Mminimum fan speed
VE6	60	0	100	%	Start-up fan speed
VE7	0	0	9999	s	Fan start-up time
VE8	72	0	1000	- - - -	Air flow rate
PARAM.	DEFAULT	MIN.	MAX.	U.M.	MACHINE TYPE CONFIGURATION
UC1	0	0	4	- - - -	Machine type 0= Direct expansion 1= Evaporator 2= Chilled water 3= Free cooling 4= Hybrid unit
UC2	1	0	1	- - - -	Primary Source Selection 0= Direct expansion (DX) 1= Chilled water (CW)
UC3	0	0	1	- - - -	Secondary Source Selection
PARAM.	DEFAULT	MIN.	MAX.	U.M.	DIRECT EXPANSION CONFIGURATION
DX1	1	1	2	- - - -	Number of compressors
DX2	0	0	1	- - - -	Enable compressor inverter 0= No 1= Yes
DX3	0	0	1	- - - -	Type of compressor rotation 0= FIFO+HS 1= LIFO+HS
DX4	0	0	1	- - - -	Enable EVDRIIVE 0= No 1= Yes
PARAM.	DEFAULT	MIN.	MAX.	U.M.	HEATING CONFIGURATION

HE1	0	0	3	----	Heating 0= No 1= Stage heaters 2= Modulating coil 3= Water valve
HE2	1	1	2	----	Electric coil stages number
HE3	1	0	1	----	Type of stage switch on 0= Linear 1= Stepped
PARAM.	DEFAULT	MIN.	MAX.	U.M.	HUMIDITY REGULATION
	100	0	100	%	Humidity production percentage
	1	0	1	----	Cooling and humidifying together 0= No 1= Yes
	1	0	1	----	Dehumidification 0= No 1= Yes
	100	0	100	%	Minimum dehumidification request to trigger regulation
	60	0	100	%	Minimum dehumidification limit
	0	0	1	----	Partial dehumidification 0= No 1= Yes
	4,0	0,1	20,0	°C/°F (1)	Dehumidification lock offset
PARAM.	DEFAULT	MIN.	MAX.	U.M.	CONDENSATION REGULATION SETTING
CS1	0	0	2	----	Condenser regulation 0= No 1= Proportional 2= AutoSet-point
CS2	10	0	100	%	Condensation minimum request
CS3	100	0	100	%	Condensation maximum request
CS4	50	0	100	%	Condensation start-up request
CS5	10	0	999	s	Condensation start-up time

CS6	100	0	100	%	Override with probe error
CS7	5	1	900	Min	AutoSet-point time
CS8	20	0	50	%	AutoSet -point minimum request
PARAM.	DEFAULT	MIN.	MAX.	U.M.	DRY COOLER REGULATION SETTING
DS1	0	0	2	-----	Dry cooler regulation 0= No 1= Proportional 2= AutoSet -point
DS2	10	0	100	%	Minimum fan speed
DS3	100	0	100	%	Maximum fan speed
DS4	50	0	100	%	Start-up fan speed
DS5	10	0	999	s	Fan start-up time
DS6	2,0	0,0	10,0	°C/°F (1)	Fan cut-off
DS7	100	0	100	%	Override with probe error
DS8	5	1	900	Min	AutoSet-point time
DS9	20	0	50	%	AutoSet-point minimum speed
PARAM.	DEFAULT	MIN.	MAX.	U.M.	WATER PUMP CONFIGURATION
PS1	0	0	2	-----	Water pump regulation type 0= No 1= Unit ON 2= Cooling request
PS2	60	0	999	s	Pump switch-off delay
PARAM.	DEFAULT	MIN.	MAX.	U.M.	SET-POINT LIMITS CONFIGURATION
SL1	15,0	-40,0	150,0	°C/°F (1)	Temperature set-point minimum threshold
SL2	40,0	-40,0	150,0	°C/°F (1)	Temperature set-point maximum threshold
SL3	20	0	100	%Rh	Humidity set-point minimum limit
SL4	75	0	100	%Rh	Humidity set-point maximum limit
PARAM.	DEFAULT	MIN.	MAX.	U.M.	NEUTRAL ZONE CONFIGURATION

ZM1	0,2	0,0	10,0	°C/°F (1)	Temperature neutral zone
ZM2	2	0,0	20,0	%	Humidity neutral zone
PARAM.	DEFAULT	MIN.	MAX.	U.M.	LOCAL NETWORK CONFIGURATION
LN1	17	1	17	----	Network address
LN2	0	0	1	----	Network operation 0= No 1= Yes
LN3	2	2	16	----	Number of networked units
LN4	0	0	15	----	Number of stand-by units
LN5	0	0	1	----	Enables unit rotation 0= No 1= Yes
LN6	12	1	9999	h	Rotation interval
LN7	0	0	1	----	Enable support 0= No 1= Yes
LN8	120	1	9999	s	Support switch-on time
LN9	1	0	1	----	Dynamic On/Off 0= No 1= Yes
LN10	1	0	1	----	Dynamic set-point 0= No 1= Yes
PARAM.	DEFAULT	MIN.	MAX.	U.M.	ALARM MANAGEMENT CONFIGURATION
AS1	300	0	9999	s	Temperature and humidity alarms delay
AS2	150	0	9999	s	Shutter status alarm delay
AS3	180	0	9999	s	Compressor low pressure alarm delay
AS4	60	0	9999	s	Compressor discharge high temperature alarm delay
AS5	60	0	9999	s	Compressor low compression alarm delay

AS6	1	0	1	----	Smoke/fire alarm reset type 0= Automatic 1= Manual
AS7	30	0	9999	s	Start-up flow alarm delay
AS8	50	0	9999	s	Flow alarm delay
AS9	2	0	2	----	Unit power failure alarm 0= No 1= Yes 2= Unit ON
PARAM.	DEFAULT	MIN.	MAX.	U.M.	VARIOUS CONFIGURATION
BT1	0	BT1	2	----	Enable keylock 0= No 1= Yes 2= User password
PARAM.	DEFAULT	PARAM.	MAX.	U.M.	PASSWORD
MPW	2	MPW	9999	----	Manufacturer Password

12.4 Advanced loop setup: components configuration

PARAM.	DEFAULT	MIN.	MAX.	U.M.	PARAMETERS
DP1	0	0	1	----	Default values restore 0= No 1= Yes
PARAM.	DEFAULT	MIN.	MAX.	U.M.	BAUDRATE LOCAL NETWORK
BR1	2	1	4	----	Baud rate 1= 20K 2= 50K 3= 125K 4= 500K
PARAM.	DEFAULT	MIN.	MAX.	U.M.	UNIT OF MEASUREMENT
MU1	0	0	1	----	Temperature unit of measurement 0= °C 1= °F

MU2	0	0	1	----	Gas pressure unit of measurement 0= Bar 1= PSI
PARAM.	DEFAULT	MIN.	MAX.	U.M.	TYPE OF PROBE
PC1	1	0	4	----	Room temperature 0= PTC 1= NTC 2= NTC10K2 3=NTC10K3 4=PT100
PC2	1	0	4	----	Supply temperature 0= PTC 1= NTC 2= NTC10K2 3=NTC10K3 4=PT100
PC3	1	0	4	----	IN Water temperature 0= PTC 1= NTC 2= NTC10K2 3=NTC10K3 4=PT100
PC7	1	0	3	----	Room humidity 0= 0-20mA 1= 4-20mA 2=0-5V 3=0-10V
PC8	10	0	100	%Rh	Minimum room humidity
PC9	90	0	100	%Rh	Maximum room humidity
PC13	2	0	3	----	Air differential pressure 0= 0-20mA 1= 4-20mA 2=0-5V 3=0-10V
PC14	0	-5000	5000	Pa	Minimum air differential pressure
PC15	5000	-5000	5000	Pa	Maximum air differential pressure
PC16	0.5	0	20,00	Pa	Minimum air differential pressure

PC17	4.5	0	20,00	Pa	Maximum air differential pressure
PARAM.	DEFAULT	MIN.	MAX.	U.M.	VENTILATION CONFIGURATION
FA1	5	1	100	s	Modulation speed
FA2	100	100	900	m ³ /h	Flow neutral zone
FA3	2	1	100	Pa	Pressure neutral zone
FA4	1	1	5	- - - -	Number of MB fans with machine OFF alarm underway
FA5	20	0	9999	s	Supply fan ON delay from damper limit switch
PARAM.	DEFAULT	MIN.	MAX.	U.M.	LIMIT TEMPERATURE
LM1	0.2	-20,0	20,0	°C/°F (1)	Supply temperature differential
PARAM.	DEFAULT	MIN.	MAX.	U.M.	FREE COOLING REGULATION
SF1	60	0	9999	s	Compressor switch on delay in support to FC
SF2	20	0	9999	s	FC override switch-off time after compressors switch-off
PARAM.	DEFAULT	MIN.	MAX.	U.M.	CHILLED WATER
WS1	0	0	100	%	Valve minimum opening
WS2	100	0	100	%	Valve maximum opening
PARAM.	DEFAULT	MIN.	MAX.	U.M.	HEATING
HS1	0	0	100	%	Minimum heating
HS2	100	0	100	%	Maximum heating
HS3	5	0	99	s	Stages activation delay
PARAM.	DEFAULT	MIN.	MAX.	U.M.	DIRECT EXPANSION
XS1	5	1	6	- - - -	Type of refrigerant 1=R22 2=R134a 3=R404A 4=R407C 5=R410A 6=R507

XS2	0	0	1	----	Low pressure presence 0= No 1= Yes
XS3	4,0	0,0	10,0	Barg	Low pressure set-point
XS4	0,5	0,0	10,0	Barg	Low pressure differential
XS5	5	0	9999	s	Minimum switch on time between one compressor and another
XS6	180	0	9999	s	Minimum time of compressor OFF
XS7	180	0	9999	s	Minimum time of compressor ON
XS8	4	0	9999	H	Compressor hours maximum difference
XS9	1	0	50	----	Hours rotation factor
XS10	1	0	50	----	Switch-on factor
XS11	110,0	0,0	200,0	°C/°F (1)	Discharge temperature protection threshold
XS12	115,0	0,0	200,0	°C/°F (1)	Discharge temperature alarm threshold
XS13	1=Yes	0	1	----	Condensation with compressor on 0= No 1= Yes
XS14	30,0	25,0	100,0	°C/°F (1)	Condensation cut-off set-point
XS15	2,0	0,0	10,0	----	Low compression alarm limit
XS16	0 = No	0	1	----	Enable pump down 0= No 1= Yes
XS17	2,0	0,0	10,0	Barg	Pump down end limit
PARAM.	DEFAULT	MIN.	MAX.	U.M.	COMPRESSOR INVERTER
IS1	0	0	100	%	Minimum speed
IS2	100	0	100	%	Maximum speed
IS3	40	0	100	%	Start-up speed
IS4	20	0	200	rps	Discharge temperature decrease
PARAM.	DEFAULT	MIN.	MAX.	U.M.	EXPANSION VALVE 1

EV1	4	1	28	- - - -	<p>Type of valve</p> <p>1= Sporlan SER AA 2= Sporlan SER A 3= Sporlan SER B 4= Sporlan SER C 5= Sporlan SER D 6= Sporlan SERI F 7= Sporlan SERI G 8= Sporlan SERI J 9= Sporlan SERI K 10= Sporlan SERI L 11= Sporlan SEHI 175 12= Sporlan SEHI 400 13= Sporlan ESX 14= Sporlan EDEV B/C (unipolar) 15= Sporlan reserved 16= Sporlan reserved 17= Sporlan SER 1.5 to 20 18= Sporlan SEI 30 19= Sporlan SEI 50 20= Sporlan SEH 100 21= Sporlan SEI 0.5 to 11 22= Alco EXM/EXL-246 23= Alco EX4 TO 6 24= Alco EX7 25= Alco EX8 26= Danfoss ETS 12.5-25-50 27= Danfoss ETS 100-250 28= Danfoss ETS 400</p>
EV2	0	0	1	Hz	<p>Electric frequency</p> <p>0= 50 1= 60</p>
EV3	0	0	1	- - - -	<p>Operating mode</p> <p>0= SH algo 1= Manual</p>
EV4	0	0	100		Manual position
EV5	0	0	1	- - - -	<p>Resynchronization request</p> <p>0= No 1= Yes</p>
EV6	6,0	3,0	25,0	K	SH set-point
EV7	3,0	1,0	3,0	K	LoSH set-point
EV8	15,0	10,0	40,0	K	HiSH set-point

EV9	-3,0	-40,0	40,0	K	LOP set-point
EV10	12,0	-40,0	40,0	K	MOP set-point
EV11	40,0	1,0	100,0	K	PID – proportional band
EV12	120	0	999	sec	PID – integral time
EV13	30	0	999	sec	PID – derivative time
EV14	5	1	255	sec	Stabilization time
EV15	100	0	100	%	Stabilization position
EV16	30	0	255	sec	Start-up time
EV17	50	0	100	%	Start-up position
EV18	1	0	1	----	Evaporation pressure sensor type 0= 4..20mA 1= 0-5V
EV19	0,0	-1,0	870,0	bar	Minimum evaporation pressure
EV20	17,3	-1,0	870,0	bar	Maximum evaporation pressure
EV21	0,0	-5,0	5,0	bar	Evaporation pressure offset
EV22	1	0	1	----	Condensation pressure sensor type 0= 4..20mA 1= 0-5V
EV23	0,0	-1,0	870,0	bar	Minimum condensation pressure
EV24	45,0	-1,0	870,0	bar	Maximum condensation pressure
EV25	0,0	-5,0	5,0	bar	Condensation pressure offset
EV26	0,0	-10,0	10,0	°C/°F (1)	Suction temperature offset
EV27	0,0	-10,0	10,0	°C/°F (1)	Discharge temperature offset
PARAM.	DEFAULT	MIN.	MAX.	U.M.	EXPANSION VALVE 2
EV29	4	1	28	----	Type of valve 1= Sporlan SER AA 2= Sporlan SER A 3= Sporlan SER B 4= Sporlan SER C 5= Sporlan SER D 6= Sporlan SERI F

					7= Sporlan SERI G 8= Sporlan SERI J 9= Sporlan SERI K 10= Sporlan SERI L 11= Sporlan SEHI 175 12= Sporlan SEHI 400 13= Sporlan ESX 14= Sporlan EDEV B/C (unipolar) 15= Sporlan reserved 16= Sporlan reserved 17= Sporlan SER 1.5 to 20 18= Sporlan SEI 30 19= Sporlan SEI 50 20= Sporlan SEH 100 21= Sporlan SEI 0.5 to 11 22= Alco EXM/EXL-246 23= Alco EX4 TO 6 24= Alco EX7 25= Alco EX8 26= Danfoss ETS 12.5-25-50 27= Danfoss ETS 100-250 28= Danfoss ETS 400
EV30	0	0	1	Hz	Electric frequency 0= 50 1= 60
EV31	0	0	1	----	Operating mode 0= SH algo 1= Manual
EV32	0	0	100	%	Manual position
EV33	0	0	1	----	Resynchronization request 0= No 1= Yes
EV34	6,0	3,0	25,0	K	SH set-point
EV35	3,0	1,0	3,0	K	LoSH set-point
EV36	15,0	10,0	40,0	K	HiSH set-point
EV37	-3,0	-40,0	40,0	K	LOP set-point
EV38	12,0	-40,0	40,0	K	MOP set-point
EV39	40,0	1,0	100,0	K	PID – proportional band
EV40	120	0	999	sec	PID – integral time
EV41	30	0	999	sec	PID – derivative time

EV42	5	1	255	sec	Stabilization time
EV43	100	0	100	%	Stabilization position
EV44	30	0	255	sec	Start-up time
EV45	50	0	100	%	Start-up position
EV46	1	0	1	----	Evaporation pressure sensor type 0= 4..20mA 1= 0-5V
EV47	0,0	-1,0	870,0	bar	Minimum evaporation pressure
EV48	17,3	-1,0	870,0	bar	Maximum evaporation pressure
EV49	0,0	-5,0	5,0	bar	Evaporation pressure offset
EV50	1	0	1	----	Condensation pressure sensor type 0= 4..20mA 1= 0-5V
EV51	0,0	-1,0	870,0	bar	Minimum condensation pressure
EV52	45,0	-1,0	870,0	bar	Maximum condensation pressure
EV53	0,0	-5,0	5,0	bar	Condensation pressure offset
EV54	0,0	-10,0	10,0	°C/°F (1)	Suction temperature offset
EV55	0,0	-10,0	10,0	°C/°F (1)	Discharge temperature offset
PARAM.	DEFAULT	MIN.	MAX.	U.M.	DE-SUPERHEATING CONFIGURATION
SH1	1	0	2	----	Enable SH modulating mode 0= No 1= Safety 2= Yes
SH2	5,0	1,0	25,0	K	SH minimum set-point
SH3	12,0	3,0	25,0	K	SH maximum set-point
SH4	15,0	0,0	50,0	K	DSH minimum set-point
SH5	35,0	0,0	50,0	K	DSH maximum set-point
SH6	20,0	0,0	50,0	K	Minimum DSH threshold to activate SH modulation

SH7	30,0	0,0	50,0	K	Maximum DSH threshold to activate SH modulation
PARAM.	DEFAULT	MIN.	MAX.	U.M.	PASSWORD
APW	3	0	9999	- - - -	Advanced password
PARAM.	DEFAULT	MIN.	MAX.	U.M.	ALARMS LOG
CSA	0	0	1	- - - -	Deletes alarm log 0= No 1= Yes

Notes:



(1) Temperature unit of measurement depends on MU1 parameter (°C= 0; °F= 1)

13 UNIT ALARMS MANAGEMENT

13.1 Signalling, check and clearance of alarm conditions

13.1.1 Alarm presence signalling

The presence of one or more active alarms is signalled by:

- Activation of the **Buzzer** incorporated in the user terminal.
- Illumination of the **RED LED** on the front panel of the user terminal ();
- Alarm presence icon () is displayed in the program's main page.
- If the alarm is **CRITICAL**, and therefore blocks unit operation, the **GREEN LED** () starts flashing.

13.1.2 Alarm condition check

Press and hold the **ALARM** () key to display on the user terminal the message corresponding to the active alarm. The Buzzer is shut off.

Use the **ENTER** () key to scroll through all active alarm signals.

Press **ESC** () to return to the main program page.

13.1.3 Resetting an alarm

While an alarm is displayed, press **ENTER** () for a few seconds, to clear the displayed alarm.

Alarms whose causes have not been restored yet cannot be removed.

14 DESCRIPTION OF UNIT'S ALARMS

The following table shows the meaning of the device's alarm codes.

CODE	ALARMS THAT CAUSE THE UNIT SHUT-OFF
AL7	Flow alarm
	Cause:
	- Water flow insufficient (the flow switch does not operate)
	Delay:
	- On start: According to parameter - In operation: According to parameter
	Effect:
	- The intervention causes the unit to shut off. All devices will be stopped without complying with operating times.
Solutions:	
- Check the hydraulic system	
Restore:	
- The alarm is manually restored	
AL9	Damper status alarm
	Cause:
	- The motorised shutters of the unit are closed
	Delay:
	- On start: According to parameter - In operation: 5 s
	Effect:
	- The intervention causes the unit to shut off. All devices will be stopped without complying with operating times.
Solutions:	
- Check damper motor	
- Check damper motor electrical connection	
- Check damper status	
Restore:	
- The alarm is manually restored	

<p>AL40</p>	<p>General supply fan alarm</p> <p>Cause:</p> <ul style="list-style-type: none"> - The unit fans are blocked because of the intervention of the air flow or electric fan protection sensor. <p>Delay:</p> <ul style="list-style-type: none"> - On start: 40 s - In operation: 5 s <p>Effect:</p> <ul style="list-style-type: none"> - The intervention causes the unit to shut off - All devices will be stopped without complying with operating times <p>Solutions:</p> <ul style="list-style-type: none"> - Check for any air system problems that may reduce the unit's air flow - Check electrical connection of the air flow sensor and fan electrical protection - Check fan speed - Check the condition of the fan <p>Restore:</p> <ul style="list-style-type: none"> - The alarm is manually restored
	<p>AL23 AL24 AL25 AL26 AL27</p>
<p>AL41</p>	
	<p>CODE</p>

<p>AL1 AL2 AL3 AL4 AL5</p>	<p>A specific alarm will trigger for each probe / sensor</p> <p>Broken return humidity probe alarm</p> <p>Broken return temperature probe alarm</p> <p>Broken differential air pressure sensor alarm</p> <p>Broken supply temperature probe alarm</p> <p>Broken IN/Free cooling water temperature probe alarm</p> <p>Cause:</p> <ul style="list-style-type: none"> - The sensor or the probe is broken or disconnected <p>Delay:</p> <ul style="list-style-type: none"> - On start: 10 s - In operation: 10 s <p>Effect:</p> <ul style="list-style-type: none"> - See previous chapters <p>Solutions:</p> <ul style="list-style-type: none"> - Check probe \ sensor electrical connection - Check probe \ sensor signal <p>Restore:</p> <ul style="list-style-type: none"> - The alarm is manually restored
<p>CODE</p>	<p>COMPRESSOR ALARMS</p>
<p>AL11 AL12</p>	<p>Compressor 1/2 magnetic thermal protection alarm</p> <p>Cause:</p> <ul style="list-style-type: none"> - The compressor's magnetic thermal protection has triggered an alarm <p>Delay:</p> <ul style="list-style-type: none"> - On start: 10 - In operation: 5 s <p>Effect:</p> <ul style="list-style-type: none"> - See previous chapters <p>Solutions:</p> <ul style="list-style-type: none"> - Check compressor electrical connection - Check compressor absorbed current <p>Restore:</p> <ul style="list-style-type: none"> - The alarm is manually restored
<p>AL13 AL14</p>	<p>Compressor 1/2 high pressure alarm</p> <p>Cause:</p> <ul style="list-style-type: none"> - The compressor's high pressure protection has triggered an alarm <p>Delay:</p> <ul style="list-style-type: none"> - On start: 10 - In operation: 5 s <p>Effect:</p> <ul style="list-style-type: none"> - See previous chapters <p>Solutions:</p> <ul style="list-style-type: none"> - Check the condensation pressure - Check condenser status - Check the condenser power supply line <p>Restore :</p> <ul style="list-style-type: none"> - The alarm is manually restored

AL15 AL16	<p>Compressor 1/2 low pressure alarm</p> <p>Cause:</p> <ul style="list-style-type: none"> - The compressor's low pressure protection has triggered an alarm <p>Delay:</p> <ul style="list-style-type: none"> - On start: According to parameter - In operation: 5 s <p>Effect:</p> <ul style="list-style-type: none"> - See previous chapters <p>Solutions:</p> <ul style="list-style-type: none"> - Check evaporation pressure - Check electronic expansion valve status - Check the cooling circuit <p>Restore:</p> <ul style="list-style-type: none"> - The alarm is manually restored
AL17 AL18	<p>Compressor 1/2 high discharge temperature alarm</p> <p>Cause:</p> <ul style="list-style-type: none"> - The compressor's drain high temperature protection has triggered an alarm <p>Delay:</p> <ul style="list-style-type: none"> - On start: According to parameter - In operation: According to parameter <p>Effect:</p> <ul style="list-style-type: none"> - See previous chapters <p>Solutions:</p> <ul style="list-style-type: none"> - Check the compressor temperature discharge - Check evaporation pressure - Check the cooling circuit <p>Restore:</p> <ul style="list-style-type: none"> - The alarm is manually restored
AL21 AL22	<p>Compressor 1/2 low compression alarm</p> <p>Cause:</p> <ul style="list-style-type: none"> - The compressor compression ratio is too low <p>Delay:</p> <ul style="list-style-type: none"> - On start: According to parameter - In operation: 5 s <p>Effect:</p> <ul style="list-style-type: none"> - See previous chapters <p>Solutions:</p> <ul style="list-style-type: none"> - Check compressor rotation direction - Check evaporation pressure - Check the cooling circuit <p>Restore:</p> <ul style="list-style-type: none"> - The alarm is manually restored
AL19 AL20	<p>Compressor 1/2 electronic expansion valve alarm</p> <p>Cause:</p> <p>The valve driver has one of the following problems:</p> <ul style="list-style-type: none"> - Communication failure - Evaporation pressure probe alarm - Condensation pressure probe alarm - Suction temperature probe alarm - Discharge temperature probe alarm <p>Delay:</p> <ul style="list-style-type: none"> - On start: 30 s - In operation: 30 s <p>Effect:</p> <ul style="list-style-type: none"> - See previous chapters <p>Solutions:</p> <ul style="list-style-type: none"> - Check valve driver connection - Check probe connection - Check probe signal

	<p>Restore:</p> <ul style="list-style-type: none"> - The alarm is manually restored
CODE	COMPONENT ALARMS
AL6	<p>Water presence/ Condensate drain pump sensor alarm</p> <p>Cause:</p> <ul style="list-style-type: none"> - The water detecting system is in alarm - The condensation drain pump is in alarm <p>Delay:</p> <ul style="list-style-type: none"> - On start: 10 s - In operation: 5 s <p>Effect:</p> <ul style="list-style-type: none"> - According to parameter <p>Solutions:</p> <ul style="list-style-type: none"> - Check water detection probe connection - Check for water on the water detection probe - Check condensate drain pump connection - Check condensate drain pump status <p>Restore:</p> <ul style="list-style-type: none"> - The alarm is manually restored
AL8	<p>Electric coil safety thermostat alarm</p> <p>Cause:</p> <ul style="list-style-type: none"> - The electric heater has overheated <p>Delay:</p> <ul style="list-style-type: none"> - On start: 10 s - In operation: 5 s <p>Effect:</p> <ul style="list-style-type: none"> - The electric heater will be stopped <p>Solutions:</p> <ul style="list-style-type: none"> - Check fan speed - Check fan air flow rate - Check the aeraulic circuit <p>Restore:</p> <ul style="list-style-type: none"> - The alarm is manually restored
AL10	<p>Clogged air filter alarm</p> <p>Cause:</p> <ul style="list-style-type: none"> - The dirty filter differential pressure sensor has detected excessive pressure <p>Delay:</p> <ul style="list-style-type: none"> - On start: 10 s - In operation: 5 s <p>Effect:</p> <ul style="list-style-type: none"> - Warning only <p>Solutions:</p> <ul style="list-style-type: none"> - Check the condition of the air filters - Check pressure sensor calibration - Check pressure sensor connection - Check the aeraulic circuit <p>Restore:</p> <ul style="list-style-type: none"> - The alarm is manually restored

AL35	<p>Dry cooler general alarm</p> <p>Cause:</p> <ul style="list-style-type: none"> - The dry cooler has an alarm <p>Delay:</p> <ul style="list-style-type: none"> - On start: 10 s - In operation: 5 s <p>Effect:</p> <ul style="list-style-type: none"> - See previous chapters <p>Solutions:</p> <ul style="list-style-type: none"> - Check the dry cooler condition <p>Restore:</p> <ul style="list-style-type: none"> - The alarm is manually restored
AL36	<p>Humidifier general alarm</p> <p>Cause:</p> <ul style="list-style-type: none"> - The humidifier has an alarm <p>Delay:</p> <ul style="list-style-type: none"> - On start: 10 s - In operation: 5 s <p>Effect:</p> <ul style="list-style-type: none"> - Humidification will be stopped <p>Solutions:</p> <ul style="list-style-type: none"> - Check status of the external humidifier <p>Restore:</p> <ul style="list-style-type: none"> - The alarm is manually restored
AL37	<p>General water pump alarm</p> <p>Cause:</p> <ul style="list-style-type: none"> - The water pump has an alarm <p>Delay:</p> <ul style="list-style-type: none"> - On start: 10 s - In operation: 5 s <p>Effect:</p> <ul style="list-style-type: none"> - See previous chapters <p>Solutions:</p> <ul style="list-style-type: none"> - Check the condition of the water pump <p>Restore:</p> <ul style="list-style-type: none"> - The alarm is manually restored
AL38 AL39	<p>Condenser 1/2 general alarm</p> <p>Cause:</p> <ul style="list-style-type: none"> - The external condenser has an alarm <p>Delay:</p> <ul style="list-style-type: none"> - On start: 10 s - In operation: 5 s <p>Effect:</p> <ul style="list-style-type: none"> - See previous chapters <p>Solutions:</p> <ul style="list-style-type: none"> - Check the condition of the external condenser <p>Restore:</p> <ul style="list-style-type: none"> - The alarm is manually restored
AL42	<p>Condensing unit generic alarm</p> <p>Cause:</p> <ul style="list-style-type: none"> - The external condensing unit has an alarm <p>Delay:</p> <ul style="list-style-type: none"> - On start: 10 s - In operation: 5 s <p>Effect:</p> <ul style="list-style-type: none"> - See previous chapters <p>Solutions:</p> <ul style="list-style-type: none"> - The external condensing unit has an alarm <p>Restore:</p> <ul style="list-style-type: none"> - The alarm is manually restored

AL43	<p>Power supply failure alarm</p> <p>Cause:</p> <ul style="list-style-type: none"> - The unit's power supply has failed <p>Delay:</p> <ul style="list-style-type: none"> - On start: 5 s - In operation: 5 s <p>Effect:</p> <ul style="list-style-type: none"> - See previous chapters <p>Solutions:</p> <ul style="list-style-type: none"> - Check the unit's power supply line status <p>Restore:</p> <ul style="list-style-type: none"> - The alarm is manually restored
CODE	LAN ALARMS
AL28	<p>Local network communication alarm</p> <p>Cause:</p> <ul style="list-style-type: none"> - The unit does not detect other units in local network <p>Delay:</p> <ul style="list-style-type: none"> - On start: 30 s - In operation: 30 s <p>Effect:</p> <ul style="list-style-type: none"> - See previous chapters <p>Solutions:</p> <ul style="list-style-type: none"> - Check local network connection - Check local network parameter configuration <p>Restore:</p> <ul style="list-style-type: none"> - The alarm will be automatically reset
CODE	TEMPERATURE AND HUMIDITY ALARMS
AL29	<p>High temperature regulation alarm</p> <p>Cause:</p> <ul style="list-style-type: none"> - The regulated temperature has exceeded the alarm threshold <p>Delay:</p> <ul style="list-style-type: none"> - On start: According to parameter - In operation: According to parameter <p>Effect:</p> <ul style="list-style-type: none"> - Warning only <p>Solutions:</p> <ul style="list-style-type: none"> - Check the unit's operation status <p>Restore:</p> <ul style="list-style-type: none"> - The alarm will be automatically reset
AL30	<p>Low temperature regulation alarm</p> <p>Cause:</p> <ul style="list-style-type: none"> - The regulated temperature has exceeded the alarm threshold <p>Delay:</p> <ul style="list-style-type: none"> - On start: According to parameter - In operation: According to parameter <p>Effect:</p> <ul style="list-style-type: none"> - Warning only <p>Solutions:</p> <ul style="list-style-type: none"> - Check the unit's operation status <p>Restore:</p> <ul style="list-style-type: none"> - The alarm will be automatically reset
AL31	<p>High limit temperature alarm</p> <p>Cause:</p> <ul style="list-style-type: none"> - The limit temperature has exceeded the alarm threshold <p>Delay:</p> <ul style="list-style-type: none"> - On start: Second parameter - In operation: Second parameter <p>Effect:</p> <ul style="list-style-type: none"> - According to parameter (See previous chapters)

	<p>Solutions:</p> <ul style="list-style-type: none"> - Check the unit's operation status <p>Restore:</p> <ul style="list-style-type: none"> - The alarm will be automatically reset
AL32	<p>Low limit temperature alarm</p> <p>Cause:</p> <ul style="list-style-type: none"> - The limit temperature has exceeded the alarm threshold <p>Delay:</p> <ul style="list-style-type: none"> - On start: According to parameter - In operation: According to parameter <p>Effect:</p> <ul style="list-style-type: none"> - According to parameter (See previous chapters) <p>Solutions:</p> <ul style="list-style-type: none"> - Check the unit's operation status <p>Restore:</p> <ul style="list-style-type: none"> - The alarm will be automatically reset
AL33	<p>High humidity alarm</p> <p>Cause:</p> <ul style="list-style-type: none"> - The humidity has exceeded the alarm limit <p>Delay:</p> <ul style="list-style-type: none"> - On start: According to parameter - In operation: According to parameter <p>Effect:</p> <ul style="list-style-type: none"> - Warning only <p>Solutions:</p> <ul style="list-style-type: none"> - Check the unit's operation status <p>Restore:</p> <ul style="list-style-type: none"> - The alarm will be automatically reset
AL34	<p>Low humidity alarm</p> <p>Cause:</p> <ul style="list-style-type: none"> - The humidity has exceeded the alarm limit <p>Delay:</p> <ul style="list-style-type: none"> - On start: According to parameter - In operation: According to parameter <p>Effect:</p> <ul style="list-style-type: none"> - Warning only <p>Solutions:</p> <ul style="list-style-type: none"> - Check the unit's operation status <p>Restore:</p> <ul style="list-style-type: none"> - The alarm will be automatically reset

15 SUPERVISION THROUGH MODBUS RTU SLAVE PROTOCOL

c-pro 3 kilo CLOSE may be fitted as part of a supervisory and/or BMS (Building Management System) that adopts the standard MODBUS® RTU through a RS485 serial circuit board.

The serial communication protocol used has the following characteristics:

SERIAL COMMUNICATION PROTOCOL CHARACTERISTICS	
Protocol	MODBUS® Slave, RTU mode
Communication Std.	RS485
Baud Rate	Varies between 1200 and 38400 Baud
Word Length	8
Parity	Even
Stop Bits	1

16 SURVEY DEVICE TROUBLESHOOTING

16.1 The unit does not start

Check the following:

- The mains power supply is on.
- 24 Vac is on downstream of the supply voltage transformer.
- Proper plugging in of 24 Vac supply connector.
- The protection fuse is intact.
- The cable connecting the terminal and the main board has been connected properly.

16.2 Incorrect reading of input signals

Check the following:

- The inputs have been calibrated correctly (from program).
- Proper probe power supply.
- Proper probe connection as per wiring diagram.
- Proper probe output signal.
- The probe wires are positioned at a suitable distance from potential sources of electromagnetic interference (power cables, contactors, high-voltage cables and cables connected to devices with high voltage consumption at start-up).
- The thermal resistance level between the probe and any probe pocket is not too high. Place a little paste or conductive oil inside the pockets if necessary, in order to guarantee effective temperature transmission.

16.3 Questionable alarm signalling from digital input

Check the following:

- 24 Vac power supply presence on the alarm contact.
- The terminal is regularly inserted in its seat.
- There are no breaks upstream of the terminal.

16.4 Failed closure of a digital output

Check the following:

- 24 Vac power supply presence on the digital contact.
- The terminal is regularly inserted in its seat.
- There are no breaks downstream of the terminal.

16.5 Absence of analogue outputs

Check the following:

- 0-10 V cc analogue output signal presence.
- The terminal is regularly inserted in its seat.
- There are no breaks downstream of the terminal.

16.6 The c-pro 3 kilo CLOSE activates the watch-dog function

Check the following:

- The power cables do not run near the main board microprocessors.
- There are no sources of electromagnetic interference near the microprocessor or the data transmission cables.

16.7 Serial connection with the supervisor/bms does not work

Check the following:

- Proper setting of the unit's serial address.
- Proper setting of the unit's baud rate (communication speed).
- The type of serial cables used.
- Correct serial cable connection based on the wiring diagram.
- The power cables do not run near the main board microprocessors.
- There are no sources of electromagnetic interference near the microprocessor or the data transmission cables.

16.8 Local network connection does not work

Check the following:

- Proper setting of the unit's serial address.
- Proper setting of the unit's baud rate (communication speed).
- The type of serial cables used.
- The power cables do not run near the main board microprocessors.
- There are no sources of electromagnetic interference near the microprocessor or the data transmission cables.

16.9 MODBUS master connection does not work

Check the following:

- Correct serial cable connection based on the wiring diagram.
- The power cables do not run near the main board microprocessors.
- There are no sources of electromagnetic interference near the microprocessor or the data transmission cables.

17 ACCESSORIES

17.1 RS-485/USB EVIF20SUXI Serial interface

17.1.1 General information

Using the interface it is possible to connect the main controller (*c-pro 3 kilo CLOSE*) and the bipolar stepper electronic expansion valves driver (EVDRIIVE03) to the Parameters Manager set-up software system.



17.2 EVUSB4096M 4 GB USB flash drive

17.2.1 General information

Using the key it is possible to upload and download the controller configuration parameters (*c-pro 3 kilo CLOSE*).



17.3 EVKEY10 Programming key

17.3.1 General information

Using the key it is possible to upload and download the bipolar stepper electronic expansion valves driver (EVDRIIVE03) configuration parameters.



17.4 0026700005 Frontal plate

17.4.1 General information

Using the plate it is possible to integrate the remote user interface (**Vgraph O**) in both residential and commercial environments.
The plate is black.



17.5 Gasket 0027000018 (Descrizione della guarnizione con codice 0027000007)

17.5.1 General information

Using the gasket it is possible to guarantee the remote user interface (**Vgraph O**) an IP65 protection rating when it is panel mounted.



17.6 Double-sided tape 0043600013

17.6.1 General information

Using the double sided tape is possible to mount the remote user interface (**Vgraph O**) when it is back-panel mounted.(installation is by back-panel)



17.7 Backup module

17.7.1 General information

Using the module it is possible to close the valve in case of lack of power supply to the bipolar stepper electronic expansion valves driver (EVDRIIVE03).



17.8 CJAV18 and CJAV20 connecting kit

17.8.1 General information

Using the connectors it is possible to wire the main controller. (*c-pro 3 kilo CLOSE*).



17.9 CJAV23 connecting kit

17.9.1 General information

Using the kit it is possible to wire the bipolar stepper electronic expansion valves driver (EVDRIVE03).



17.10 CJAV25 connecting kit

17.10.1 General information

Using the kit it is possible to wire the backup module (EPS4B).



c-pro 3 CLOSE

Control solution for close control units

Installer manual ver. 1.0

GA - 18/15

Code 144CP3KCI104

This document is exclusive property of EVCO. EVCO does not assume any liability regarding possible errors stated.

The customer (manufacturer, installer or final user) assumes all liability regarding configuration of the device.

EVCO does not take any responsibility for damages coming by the non-observance of additional information.

EVCO reserves the right to make any change without prejudice the basic safety and operating features.



EVCO S.p.A.

Via Feltre 81, 32036 Sedico Belluno ITALIA

Phone 0437/8422 | Fax 0437/83648

info@evco.it | www.evco.it