

Vcolor 318/328 M & L

Top-floor controllers for bread and pizza ovens, with a 5 or 7-inch colour TFT touch-screen graphic display, in split version that can be built into the unit.





Important

Read this document carefully before installation and before using the device and take all the prescribed precautions. Keep this document with the device for future consultation.

Only use the device in the ways described in this document.

Do not use the device as safety device.



Disposal

The device must be disposed of according to local regulations governing the collection of electrical and electronic waste.

Index

1	INTRODUCTION.....	4	12	Alarm management.....	31
1.1	Introduction	4	13	ACCESSORIES	33
1.2	Table listing the models available, their main features and purchasing codes.....	5	13.1	Safety transformer (ECTSFD004)	33
2	MEASUREMENTS AND INSTALLATION.....	7	13.2	Non-optoisolated RS-485/USB serial interface (EVIF20SUXI)	33
2.1	Vcolor 318M/328M user interface measurements	7	13.3	USB plug for panel installation (0812000002).....	33
2.2	Vcolor 318L/328L user interface measurements	7	13.4	Connecting cables (0810500018/0810500020)	33
2.3	User interface installation	8	13.5	4GB USB flash drive (EVUSB4096M).....	33
2.4	Installation precautions	9	14	TECHNICAL SPECIFICATIONS	34
3	ELECTRICAL CONNECTION.....	10	14.1	Technical specifications.....	34
3.1	Vcolor 318M/328M electrical connection	10			
3.2	Vcolor 318L/328L electrical connection	11			
3.3	Precautions for electrical connection.....	12			
4	DESCRIPTION	13			
4.1	User interface description	13			
4.2	Control module description	15			
5	FIRST-TIME USE.....	16			
5.1	First-time use.....	16			
6	USER INTERFACE.....	17			
6.1	Initial information	17			
6.2	Splash screen.....	17			
6.3	Stand-by screen	17			
6.4	ON screen.....	17			
6.5	Expert Screen	19			
6.6	Screen Saver	19			
7	RECIPES	21			
7.1	Initial information	21			
7.2	Saving a recipe	21			
7.3	Selecting a saved recipe	21			
7.4	Deleting a recipe	21			
8	"Weekly programmed switch-on" function.....	21			
8.1	Initial information	21			
8.2	Setting and activating the "Weekly programmed switch-on" function	21			
9	MANAGING THE LOADS	22			
9.1	Initial information	22			
9.2	Temperature regulation	22			
9.3	Steamer management.....	23			
9.4	Suction hood management	23			
9.5	Buzzer management	23			
9.6	K5 digital output management	23			
10	CONFIGURATION	24			
10.1	Initial information	24			
10.2	Setting the time, date and day of the week.....	24			
10.3	Setting configuration parameters.....	24			
10.4	Setting the language.....	24			
10.5	List of configuration parameters	25			
11	USING THE USB PORT	30			
11.1	Initial information	30			
11.2	Uploading the program settings	30			
11.3	Downloading the program settings.....	30			
11.4	Uploading the settings in the configuration parameters.....	30			
11.5	Downloading the settings in the configuration parameters.....	30			

1 INTRODUCTION

1.1 Introduction

Vcolor 318/328 is a range of stylish controllers for managing different types of top-floor ovens.

Available in split version, the user interface consists of a 5-inch (M) or 7-inch (L) capacitive TFT touch-screen graphic display in glass, 65K colours, 800 x 480 pixel resolution and IP65 protection for easy cleaning.

These controllers are suitable for different types of electric ovens due to the independent management of the power and the temperature at the top and on the floor of the oven. The model **Vcolor 318** manages top-floor heaters by electro-mechanical relays, while the model **Vcolor 328** has 2 12 VDC outputs for managing external SSRs.

They have a complete steam management system (generation, injection and venting) in both automatic and manual modes, the functions "weekly programmed switch-on", "cooking timer", "programs" and energy-saving strategies.

The user interface installed from behind using threaded studs enables it to be placed flush with the panel thus making it fit perfectly with the design of the unit.

1.2 Table listing the models available, their main features and purchasing codes

The table below lists the models available.

Models available	Vcolor 318	Vcolor 328
------------------	------------	------------

The table below shows the main features of the device.

Power supply	Vcolor 318	Vcolor 328
Control module	115...230 VAC	115...230 VAC
User interface	Powered by the control module (Vcolor 318M) or 12 VAC (Vcolor 318L)	Powered by the control module (Vcolor 328M) or 12 VAC (Vcolor 328L)
Analogue inputs (J/K)	Vcolor 318	Vcolor 328
Top probe	•	•
Floor probe	•	•
Steam probe	•	•
Digital inputs (for normally open/normally closed contact)	Vcolor 318	Vcolor 328
Thermal switch	•	•
Door switch	•	•
Multi-purpose 1	•	•
Multi-purpose 2	•	•
Digital outputs (electro-mechanical relays; A res. @ 250 VAC)	Vcolor 318	Vcolor 328
Top	8 A	
Floor	8 A	
Steam injection	8 A	8 A
Venting	8 A	8 A
Steam generation	8 A	8 A
Chamber light	16 A	16 A
Suction hood	16 A	16 A
Load 8 (configurable)	8 A	8 A

Digital outputs (solid-state relay command; 12 VDC, 15 mA max)	Vcolor 318	Vcolor 328
Top		•
Floor		•
Communications ports	Vcolor 318	Vcolor 328
RS-485 MODBUS	•	•
USB	•	•
Other features	Vcolor 318	Vcolor 328
"Cooking timer" function	•	•
"Rapid heating" function	•	•
Clock	•	•
Alarm buzzer	•	•
Independent management of the power delivered to the floor	•	•
Independent management of the top and floor temperatures	•	•
"Weekly programmed switch-on" function	•	•
"Programs" function	•	•
"Energy-saving" function	•	•

For more information see the section 14 "TECHNICAL SPECIFICATIONS".

The table below shows the purchasing codes.

Purchasing codes	Vcolor 318M (control module + 5-inch user interface kit) EVCMC318J9E
	Vcolor 328M (control module + 5-inch user interface kit) EVCMC328J9E
	Vcolor 318L (control module + 7-inch user interface kit) EVCLC318J9E
	Vcolor 328L (control module + 7-inch user interface kit) EVCLC328J9E

For more models contact the EVCO sales network.

2 MEASUREMENTS AND INSTALLATION

2.1 Vcolor 318M/328M user interface measurements

The pictures below show the measurements of the 5-inch user interface; measurements are expressed in mm (inches).

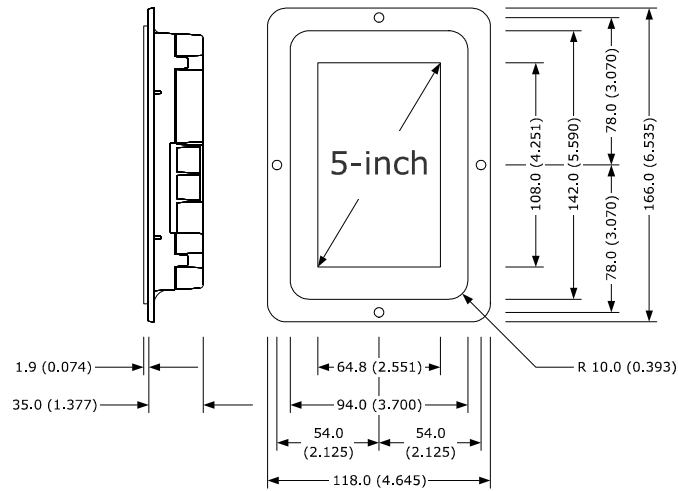

2.2 Vcolor 318L/328L user interface measurements

The pictures below show the measurements of the 7-inch user interface; measurements are expressed in mm (inches).

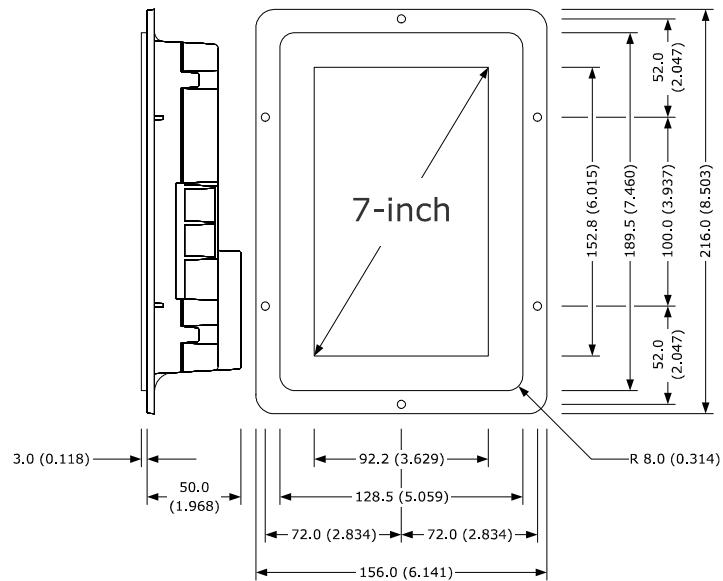

2.3 User interface installation

The picture below shows the installation of the device user interface.

The user interface is installed from behind using threaded studs, making the display flush with the front.

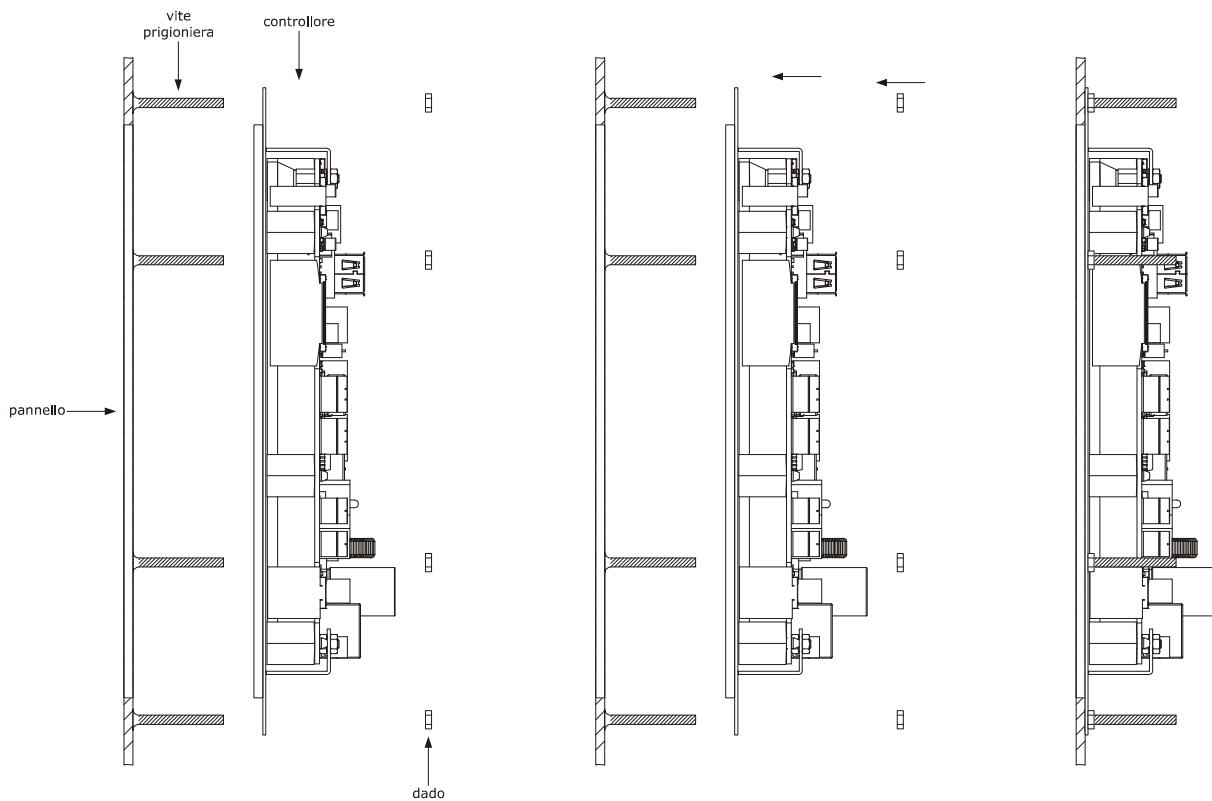

Control module measurements and installation

The pictures below show the measurements of the device control module; measurements are expressed in mm (inches).

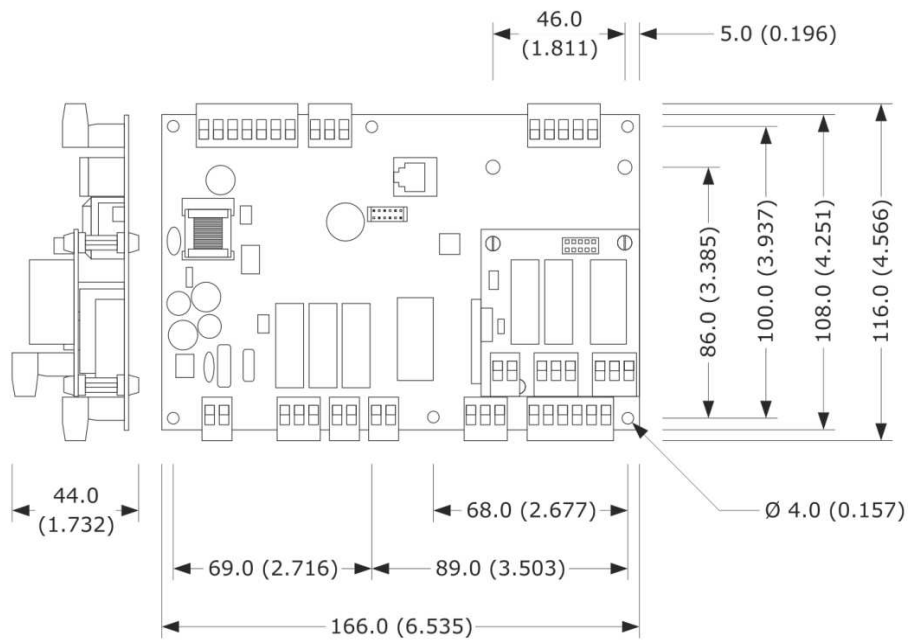

Installation is on a flat surface with spacers.

2.4 Installation precautions

- Ensure that the working conditions for the device (operating temperatures, humidity, etc.) are within the set limits. See section 15 TECHNICAL SPECIFICATIONS.
- Do not install the device close to heat sources (heaters, hot air ducts, etc.), equipment with a strong magnetic field (large diffusers, etc.), in places subject to direct sunlight, rain, damp, excessive dust, mechanical vibrations or shocks.
- Any metal parts close to the control module must be far enough away so as not to compromise the safety distance.
- In compliance with safety regulations, the device must be installed properly to ensure adequate protection from contact with electrical parts. All protective parts must be fixed in such a way as to need the aid of a tool to remove them.
- ensure that the thermocouple is properly insulated from contact with metal parts or use already insulated thermocouples.

3 ELECTRICAL CONNECTION

3.1 Vcolor 318M/328M electrical connection

The picture below shows the electrical connection of devices with a 5-inch user interface.

For more information on how to manage ventilation see subsequent pictures.

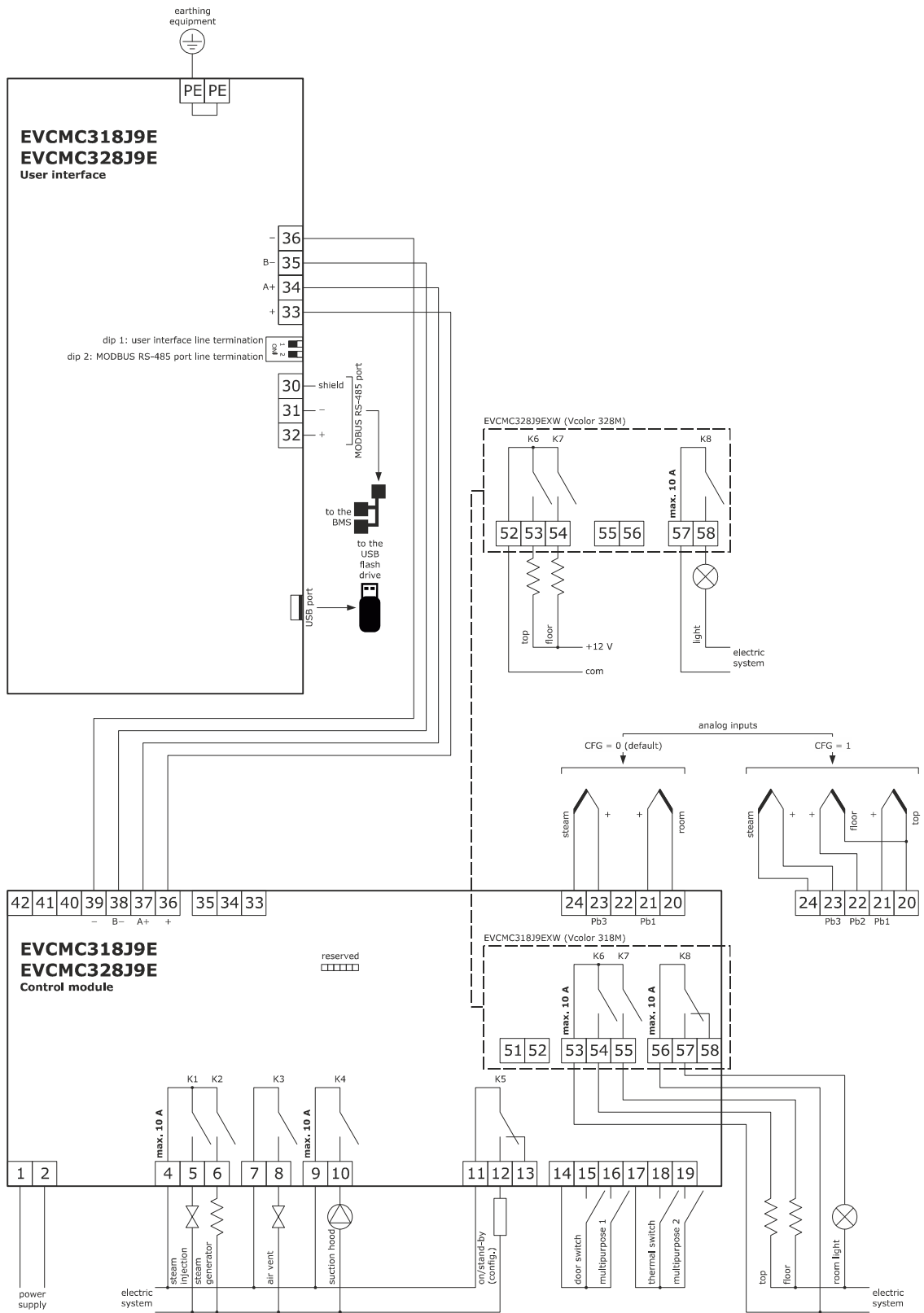

3.2 Vcolor 318L/328L electrical connection

The picture below shows the electrical connection of the device with a 7-inch user interface.

For more information on how to manage ventilation see subsequent pictures.

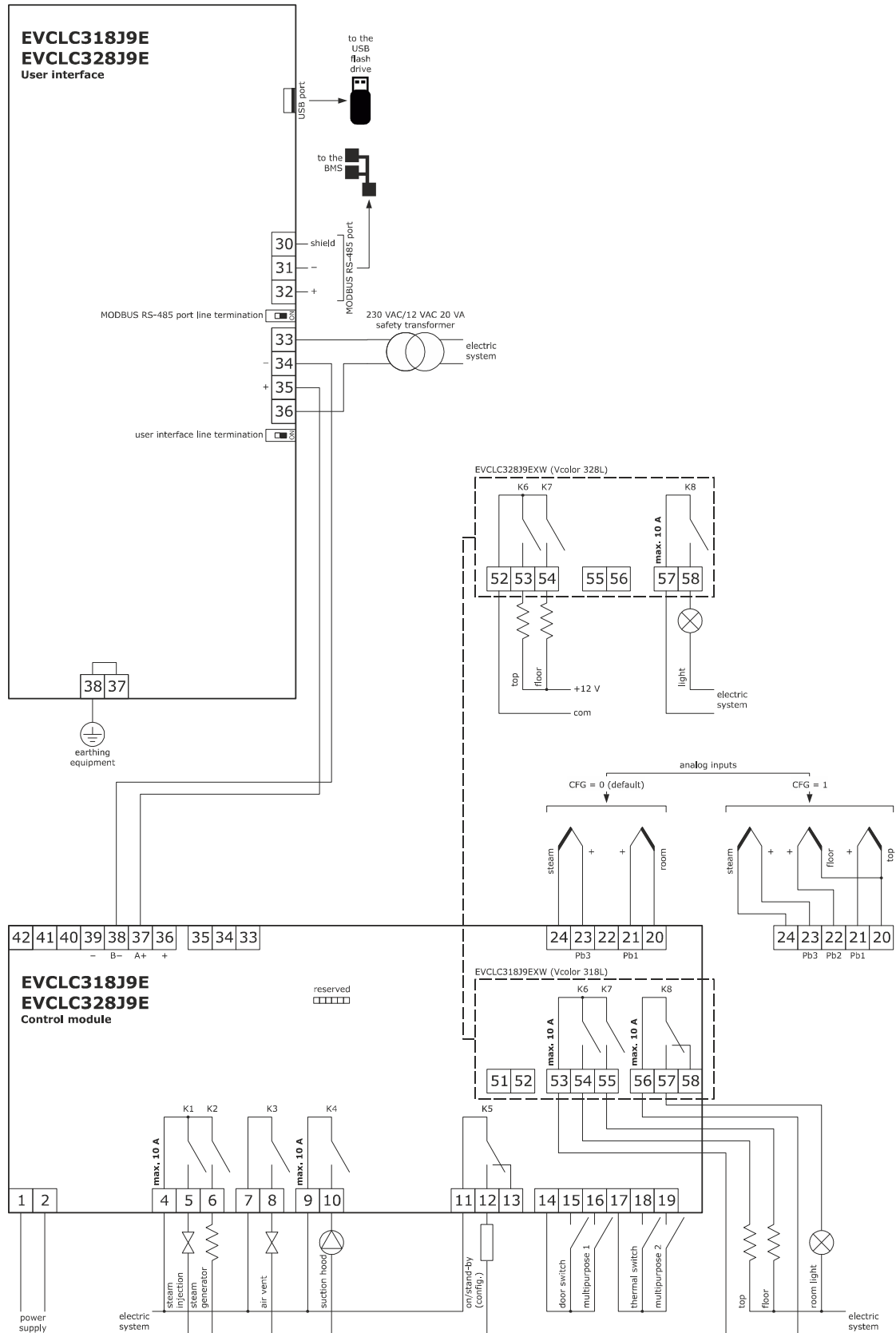

Example of connection of a motorised venting solenoid valve.

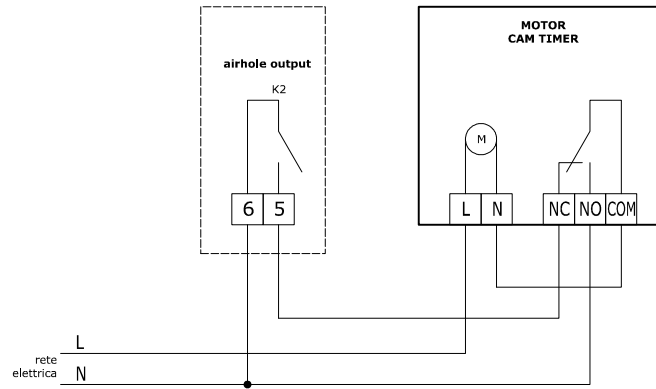

The diagram below shows functioning with the following parameters set.

- u2 = 140 (14 seconds) pause time for cam to run
- u3 = 10 (1 second) motor activation time for short milling output
- u4 = 30 (3 seconds) motor activation time for long milling output

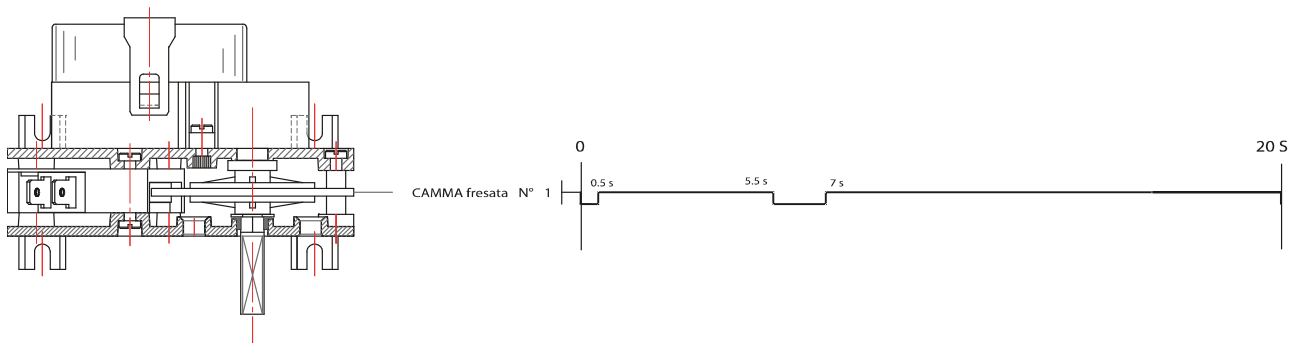

3.3 Precautions for electrical connection

- Do not use electric or pneumatic screwdrivers on the terminal blocks of the device.
- If the device has been moved from a cold to a warm place, the humidity may cause condensation to form inside. Wait about an hour before switching on the power.
- Make sure that the supply voltage, electrical frequency and power of the device correspond to the local power supply. See section 15 TECHNICAL SPECIFICATIONS.
- Disconnect the device from the power supply before doing any type of maintenance.
- Connect the power cables as far away as possible from those for the signal.
- To reduce reflections on the signal transmitted along the cables connecting the user interface to the control module it is necessary to fit a termination resistor.
- Ensure that the thermocouple is properly insulated from contact with metal parts or use already insulated thermocouples.
- For repairs and for further information on the device, contact the EVCO sales network.

4 DESCRIPTION

4.1 User interface description

The picture below shows the front view of the device user interface.

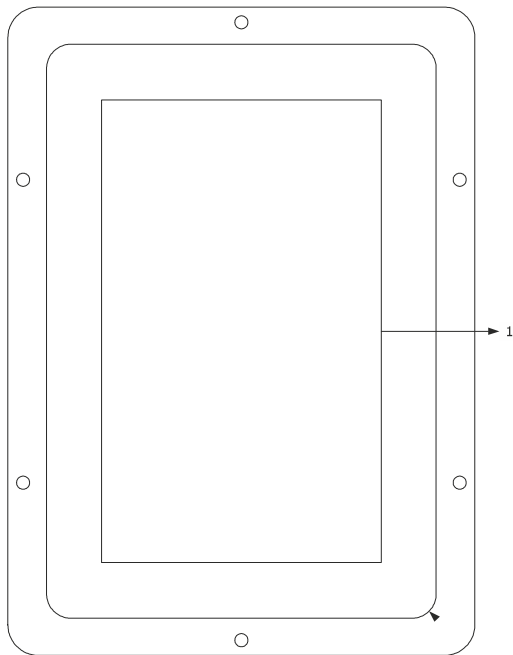

The table below describes the front parts of the device user interface.

PART	DESCRIPTION
1	display

The picture below shows the back view of the device user interface.

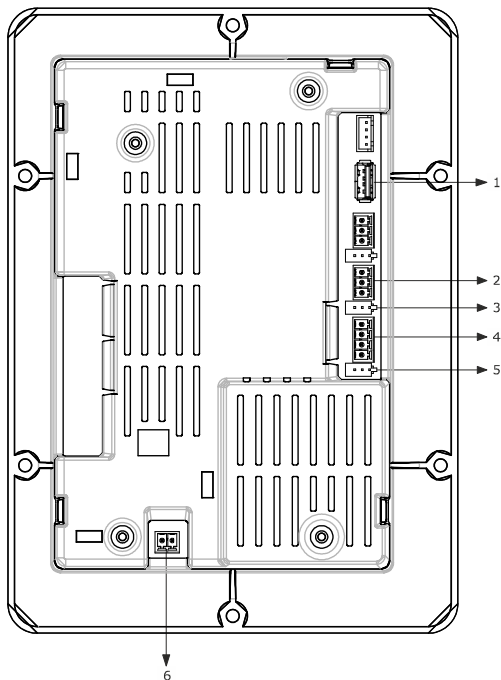

The table below describes the back parts of the device user interface.

PART	DESCRIPTION
1	USB port
2	MODBUS communications port
3	dip switch for the termination resistor for the RS-485 MODBUS port
4	communications port with the user interface (power supply)
5	dip switch
6	earthing

For more information see subsequent sections.

4.2 Control module description

The diagram below shows the intended use of the control module connectors.

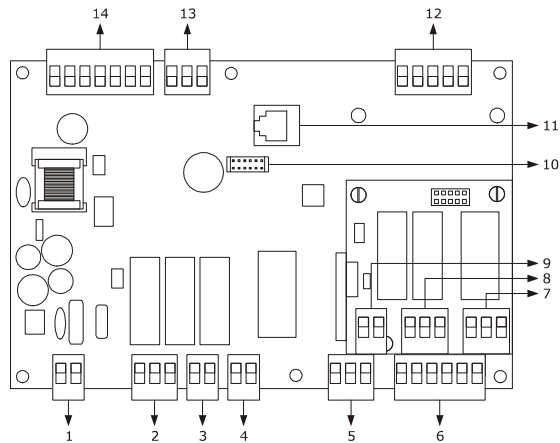

PART	DESCRIPTION
1	control module power supply
2	K1 and K2 relays
3	K3 relay
4	K4 relay
5	K5 relay
6	digital inputs
7	K8 relay
8	K6 and K7 relays
9	unused
10	unused
11	unused
12	analogue outputs
13	unused
14	user interface – control module connection

For more information see subsequent sections.

5 FIRST-TIME USE

5.1 First-time use

Proceed as follows.

1. Install the device as shown in section 2 MEASUREMENTS AND INSTALLATION taking all the precautions mentioned in paragraph 0 Installation precautions.
2. Make the electrical connection as shown in section 3 ELECTRICAL CONNECTION.
3. Connect the power supply to the device: the device will show a splash screen for some seconds.
4. Set the time, date and day of the week. See paragraph 10 CONFIGURATION.
5. Configure the device as shown in paragraph 10.3 Setting configuration parameters.

The following table describes the main configuration parameters. The parameters are listed in the recommended configuration order.

PARAM.	DESCRIPTION	FACTORY SETTING
P0	Type of probe 0 = J thermocouple 1 = K thermocouple	0
P1	Unit of measurement 0 = °C 1 = °F N.B. moving from °C to °F and vice-versa does not automatically adapt the parameter values. Check that they are correctly set.	0
P2	Function type 0 = <u>WITH 1 ANALOGUE INPUT</u> (chamber probe, with separate management of the top and floor heating by setting the percentage of power delivered to the top and floor heaters) 1 = <u>WITH 2 ANALOGUE INPUTS</u> (top and floor probes, with separate temperature management for the top and the floor, setting 2 different temperature setpoints: one for the top heaters and one for the floor heaters)	0
P3	Enable steam injection activation mode 0 = <u>MANUAL</u> - steam injection will be enabled if the steam generator is switched on 1 = <u>REMOTE</u> - steam injection will be enabled if the steam generator is switched on and if the multi-purpose input is activated (until the input is deactivated; only if i5 = 1) 1 = <u>THERMOSTATIC</u> - steam injection will be enabled if the steam temperature regulation is activated and the steam temperature is above t1 - t3. 3 = <u>DISABLED</u> - steam injection and generation are disabled and the appropriate menu is NOT visible	0
u1	Load managed by venting output 0 = <u>ON-OFF SOLENOID VALVE</u> 1 = <u>MOTORISED SOLENOID VALVE</u> - with this setting parameters u2, u3 and u4 are relevant	0
u5	Load managed by digital output K5 0 = <u>ELECTRONICS COMPARTMENT FAN</u> - with this setting parameter u6 is relevant 1 = <u>SWITCH ON/OFF</u> 2 = <u>ACOUSTIC SIGNAL</u> 3 = <u>BURNER FAULT RESET</u>	0

Then check that the remaining settings are appropriate; see paragraph 10.5 List of configuration parameters.

For more information see the subsequent sections.

6 USER INTERFACE

6.1 Initial information

The interface has the following operating modes:

- "ON": the device is powered up and switched on; the loads can be switched on
- "STAND-BY": the device is powered up but switched off by the software; the loads are switched off
- "OFF": the device is not powered up; the loads are switched off.

6.2 Splash screen

When the control module is powered up, it defaults to the EVCO splash screen for a few seconds.



To disable it, set parameter e0 to 0.

6.3 Stand-by screen

Following the splash screen, the user interface displays the screen chosen by parameter e2.

e2 = 0

e2=1



Briefly press the ON/OFF key



to switch on the device; pressing it for 3 seconds, switches it off.

N.B. OFF status can be forced by activating multi-purpose input 1 (see parameter i5) and it can be linked to output K5 by parameter u5 (u5=1).

If the "weekly programming" function is enabled by the parameter (C5 = 1), the Planning key will also be displayed top left



making it possible to set weekly programmed switch-ons (see section 8).

Set-up key



displayed top right, makes it possible to access the date and time settings and to configure the parameters (see section 10 Configuration).

6.4 ON screen

6.4.1 Initial information

Depending on the construction features of the oven, and according to whether it has 1 or 2 analogue inputs, the controller can be regulated in two different ways that have to be correctly set with parameter P2.

P2 = 0 1 analogue input (chamber probe)

P2 = 1 2 analogue inputs (top probe and floor probe)

6.4.2 Ovens with 1 analogue input

In this type of oven, the separate temperature management for the top and the floor is obtained by setting the percentage of power delivered above (top) and below (floor). The percentages can be set individually and are not affected by each other. The following screen is displayed:



The settings for ovens with 1 analogue input are as follows.

- The chamber setpoint (shown in smaller type to the side of the chamber temperature)

- Top power
- Floor power
- Timer
- Venting
- Steam injection

6.4.3 Ovens with 2 analogue inputs

In this type of oven, the separate temperature management for the top and the floor is obtained by setting two different temperature setpoints: one for the top and one for the floor. The following screen is displayed:



The settings for ovens with 2 analogue inputs are as follows.

- Top setpoint (shown in smaller type to the side of the top temperature)
- Floor setpoint (shown in smaller type to the side of the floor temperature)
- Timer
- Venting
- Steam injection

6.4.4 Status bar

When the device is switched on, the oven is already operating and the outputs are active according to the required settings. The status bar shows the function being performed by the oven.

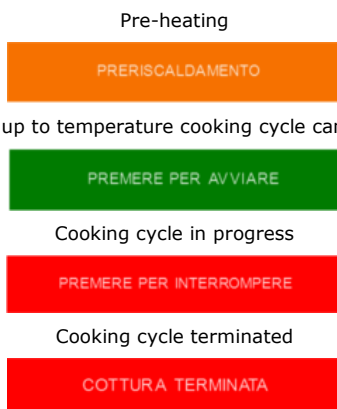

Oven up to temperature cooking cycle can begin

6.4.5 Steamer

If enabled by parameter P3 (P3≠3), the steam On/Off key will appear above the timer.



ON

Press this key to activate the steamer and the functions linked to this will be displayed. If the steamer is not yet up to temperature, the steam On/Off key lights up yellow and steam injection is disabled.



If the steamer is up to temperature, the steam On/Off key lights up green and steam injection is enabled.



The MANUAL key makes possible persistent steam injection (see parameter t0).



The AUTO key makes it possible to activate/deactivate cyclical steam injection during one cooking cycle or, if the cycle is not in progress, to pre-set this.



The SET-UP key makes it possible to access the automatic steam injection setting bar.



The following settings are possible.

- The injector-on duration (ON key)
- The injector-off duration (OFF key)
- The number of On/Off injector repeats (CYCL key)



6.4.6 Venting

The Venting key



when briefly pressed, makes it possible to change the venting status, open/closed, regardless of whether a cooking cycle is or is not in progress.

If the cycle is not in progress, pressing this key for longer enables the time to be set for the vent to open in advance before the end of the cooking cycle.

6.4.7 Light

The light On/Off key



only switches the light on if the device is on; the light goes out when the device is switched off.

6.4.8 Energy-saving function

The energy-saving key



activates the energy-saving function, except when rapid heating is in operation. For more detail, see paragraph 9.2.3.

6.4.9 Rapid heating function

This key is only visible when configured with an analogue input. The rapid heating key



activates the function making it possible to reach the regulation setpoint more quickly by activating the top and floor heaters at full power. This key is not active when energy-saving is in progress.

6.5 Expert Screen

The Expert Menu key



gives access to a screen with additional functions and information on the status of the device.

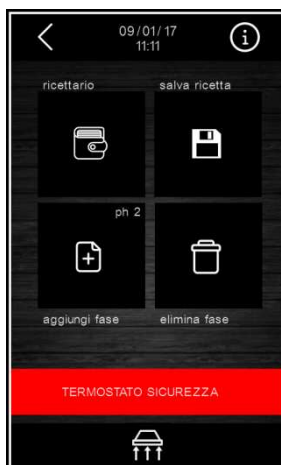

If no cooking cycle is in progress, the following functions can be activated.

- View internal values (analogue inputs, digital inputs, relay outputs)



- Select recipe from recipe book.



- Save a recipe in the recipe book.



- Add phase to a recipe.



- Delete phase from a recipe.



- Manual activation of suction hood



- View and reset alarms

If a cooking cycle is in progress, only the following functions can be activated.

- View internal values (analogue inputs, digital inputs, relay outputs)



- Manual activation of suction hood



- View and reset alarms (only if in progress)

To return to the ON screen (and in general, to return to the previous page at any level of settings you are in), touch the Back key which can be seen top left.

6.5.1 Clock and alarms

The Clock field shows the current date and time.

09/01/17
11:11

If an alarm is active, the following icon will appear in place of the Clock field.



6.6 Screen Saver

Following a period of inactivity of the keypad, which can be set using parameter e3, the display changes to the screen saver in order to enable the cooking chamber temperatures to be seen more easily.

If a cooking cycle is in progress, devices with 1 analogue input will display the percentages set and the chamber temperature, while devices with 2 analogue inputs will display the top and floor temperatures, the cooking timer, the active phase

number and the status of the top/floor outputs (a red line with the heater on, a white line with the heater off).

If no cooking cycle is in progress only the percentages/setpoints and the temperature(s) detected will be displayed.

Just touch the screen to return to the main page.

An example of a screen saver display is given below.







7 RECIPES



7.1 Initial information

A recipe can consist of one or more cooking phases, each one independent of the others.

Phases can be added or deleted using the appropriate keys on the Expert screen.

It is possible to navigate between the various phases using the  and  keys, if no cooking cycle is in progress. The number of the phase in operation is shown to the right of the timer after the letters "ph".





The desired values for each phase can be set by touching the values on display and they can be adjusted using the  or  keys or on the slide bar.

- To save the change, press the  key.
- To exit the procedure without making any changes, press the  key.

7.2 Saving a recipe







It is possible to save up to 99 recipes.

To save a recipe, proceed as follows.

1. Ensure that the device is switched on and that no cooking cycles are in progress.
2. Set the cooking cycle as explained in the previous paragraph.
3. Access the Expert screen and touch the Save recipe key.
4. Scroll through the pages of the recipe book with the list of recipes using the  or  keys and choose the desired position in which to save the recipe, giving it a new name or overwriting an existing recipe.
 - To save the change, press the  key.
 - To exit the procedure without making any changes, press the  key.

7.3 Selecting a saved recipe

To select a saved recipe, proceed as follows.

1. Ensure that the device is switched on and that no procedure is in progress.
2. Touch the Recipe book key on the Expert screen .
3. Touch  or  to select the recipe.
4. Touch the display near the recipe in question.
5. Touch  to load the settings: the recipe name will appear low down under the timer.
6. To start the cycle up touch the status bar ; to make changes to the recipe, proceed as for the manual program.
7. When a cycle starts up, the status bar  will be displayed and the cycle can be interrupted at any time.

7.4 Deleting a recipe

To delete a recipe, proceed as follows.

1. From point 4. of paragraph 7.3, touch  to delete the recipe in question.

8 "WEEKLY PROGRAMMED SWITCH-ON" FUNCTION

8.1 Initial information

If enabled by C5, the "Weekly programmed switch-on" function makes it possible to program the device to switch on weekly up to 9 times to pre-heat the oven.









The recipe will be loaded and the oven will reach the pre-set temperature for the recipe.

To set it off it must be started up manually using the appropriate key.

8.2 Setting and activating the "Weekly programmed switch-on" function



To access this system proceed as follows.

1. Ensure that at least one recipe has been saved and that the device is in stand-by mode (see paragraph 6.3).
2. Touch the  key displayed top left.
3. Touch  to set the day.
4. Touch  to set the time.
5. Touch  to retrieve the recipe from the recipe book.
6. To add a switch-on, touch the  key and repeat the procedure.
7. To delete a switch-on, touch the  key.
8. To move from one switch-on to another, use the  and  arrows at the top, checking the switch-on number displayed beside the word "Planning".

9. To return to the stand-by screen, scroll back through all the switch-ons by pressing the Back  key repeatedly.

Once the programmed switch-on has been set, the device will suggest its activation whenever it is switched off.



If there are multiple programmed switch-ons, the one closest in time will be used.

To switch the device off without activating the programmed switch-on, touch the Switch-off key.

To activate the programmed switch-on, touch the Switch-off with Planning key.

9 MANAGING THE LOADS

9.1 Initial information

This paragraph describes the loads during normal usage.

To learn the main consequences of an alarm signal, see section 13 **Errore. Non è stato specificato un nome segnalibro.** Alarm management.

9.2 Temperature regulation

The temperature is regulated by activating the related relays. When the relay activation is cyclical, switch-ons will be separated in time as much as possible to minimise the top and floor relays overlapping when they switch-on. The minimum relay switch-on is also controlled by parameter r10 (minimum duration of the temperature regulation output switch-on/off) whose value cannot be set below 10 seconds in models with electro-mechanical relays (Vcolor 318M/318L).

9.2.1 Devices with 1 analogue input (chamber probe)

The oven temperature in this type of device is regulated by the chamber probe and there are two relay outputs for the top and floor.

The regulation is always ON-OFF type. The outputs are switched on together or in sequence, according to the power set, until the temperature detected by the chamber probe

reaches the working setpoint. They are switched on again when the temperature falls below that set by parameter r0 ("working setpoint - r0").

The switch-on cycle period is set in seconds by parameter r8. The switch-on time for each load is calculated as follows

$$T_{on} = r8 * power/100$$

$$T_{off} = T_{on} - r8$$

The powers of the top and floor can be linked by setting parameter r7 to 1 (enabling the link between the power delivered to the top and to the floor), in which case the setting of the power delivered to the top causes the power delivered to the floor to be adapted automatically, and vice versa. This guarantees that the sum of the two power values is always 100.

In devices with 1 analogue input, the rapid heating function can be activated using the  key, switching on the top and floor relay outputs.

The parameters are set as follows.

- c7: chamber temperature above which the "rapid heating" function is stopped. If c7 is set at 0, the function stops when the working setpoint is reached.
- c6: this activates the "rapid heating" function when the device is switched on.

N.B. This function cannot be activated in energy-saving mode.

9.2.2 Devices with 2 analogue inputs (top and floor probes)

This type of device has two different independent oven temperature regulation systems: one operates the top probe, the other the floor probe, each linked to a top and a floor relay.

According to parameter r9, the temperature regulation can be ON-OFF or PI (Proportional-Integral).

- **ON-OFF regulation**
The output is on until the probe temperature reaches the working setpoint and it switches on again whenever the temperature falls below parameter r0 setting ("working setpoint - r0").
- **PI regulation**
Parameters r0, r8, r10 and r11 are used for PI regulation (see the List of configuration parameters).

9.2.3 Energy-saving function

The energy-saving function enables consumption to be reduced and it is activated using key  or by multi-purpose digital input 2, if parameter i7 is set at 2, and it will remain active until the input is deactivated. The maximum duration of the energy-saving function is given by parameter c8.

- **Devices with 1 analogue input**

The function cannot be activated in these devices if a "rapid heating" function is in progress. The reduction in consumption is achieved by lowering the power to the top and floor by a percentage that can be set by parameter c9. This percentage can also easily be set directly by prolonged pressure on the key. The ratio is as follows:

Power in ES= power set * c9/100

- **Devices with 2 analogue inputs**

The reduction in consumption is achieved in these devices by inhibiting the activation of the relay outputs at the same time.

For ON-OFF regulation, the switch-on cycle periods are set in seconds by parameter r8. The switch-on time for each load will be half that period, r8/2 seconds, and switch-ons will be separated in time so as to avoid overlapping.

For PI regulation, the relay activation overlap will be automatically inhibited.

9.3 Steamer management

Steam generator operations depend mainly on parameter P3 (enable steam injection) and it can be of the following types.

- 0 = Manual
- 1 = Remote
- 2 = Thermostatic
- 3 = Disabled

Switching on the steamer can also be managed automatically using parameter t6 (automatic steamer switch-on when the oven is switched on) or using the On/Off steam key.



9.3.1 Manual steam regulation (P3 = 0)

Once steamer management is enabled, the steam generator relay output is always active and steam injection is always enabled.

9.3.2 Remote steam regulation (P3 = 1)

Once steamer management is enabled, the steam generator relay output is always active.

Steam injection is enabled if the multi-purpose input has been activated, setting i5 to 1.

9.3.3 Thermostatic steam regulation (P3 = 2)

Once steamer management is enabled the steam probe activates thermostatic steam regulation.

The ON-OFF regulator parameters are as follows.

- t1 = steam setpoint
- t2 = t1 differential

Steam injection is enabled as soon as the steam setpoint is reached (steamer up to temperature). It is disabled if the

temperature detected by the steam probe falls t3 degrees below the setpoint.

9.3.4 Steam injection mode

The following parameters make it possible to personalise steam injection management (see section List of configuration parameters).

- t0 = steam injection activation mode: acts on the manual steam injection key function .
- t4 = enables constraint between cyclical steam injection and the cooking timer start-up.
- t5 = enables constraint between cyclical steam injection and the cooking timer stop.

9.4 Suction hood management

The suction hood can be activated manually by the following key,



or automatically on activation of the door switch input. In all situations the hood only switches off automatically after it has been active for 10 seconds.

9.4.1 Suction hood management with door switch input

Door switch input activation is always displayed on the screen.



The effect of the door switch input on regulation depends on parameter i4.

- 0 = no effect
- 1 = SWITCH ON THE SUCTION HOOD - the suction hood is switched on
- 2 = SWITCH ON THE SUCTION HOOD, SWITCH OFF THE TOP AND FLOOR OUTPUTS AND DISABLE STEAM INJECTION - the suction hood will be switched on, the top and floor outputs switched off and steam injection disabled, until the input is deactivated.

9.5 Buzzer management

The buzzer will be activated in the following situations.

- At the end of the cooking cycle (see parameter c0)
- For 1 second at the end of a cooking cycle phase (see parameter c1)
- On activation of an alarm

N.B. buzzer activation can be linked to the K5 output using parameter u5 (u5=2).

9.6 K5 digital output management

Digital output K5 can be configured to manage the following loads (see parameter u5).

- Electronics compartment fan (u5 = 0)
- On/Stand-by (u5 = 1)

- Acoustic signal (u5 = 2)
- Burner fault reset (u5 = 3)

9.6.1 Electronics compartment fan (u5 = 0)

Management of the electronics compartment fan depends mainly on the status of the device.

- If the device is switched on, the fan will switch on.
- If the device is switched off, the fan will switch off.

N.B. the fan may remain on when the device is switched off if the operating temperature of the control module is above the u6 threshold.

9.6.2 On/Stand-by (u5 = 1)

Management of the load connected depends on the status of the device.

- If the device is switched on, the load will be on.
- If the device is switched off, the load will be off.

9.6.3 Acoustic signal (u5 = 2)

Management of the acoustic signal depends on the buzzer status.

- If the buzzer is switched on, the load will be on.
- If the buzzer is switched off, the load will be off.

9.6.4 Burner fault reset (u5 = 3)

Burner fault reset management is only active if parameter i7 (effect caused by activation of multi-purpose input 2) is set at 3 (type 1 burner fault input) or at 4 (type 2 burner fault input).

In the event of a burner fault alarm, in both cases, to the side of the alarm signal a key is displayed that if pressed will activate the relay output for 5 seconds, resetting the gas control unit and restoring normal function.

10 CONFIGURATION



10.1 Initial information



On the standby screen touch the  key to move to the set up screen with the following functions menu. For alarms and internal values, data are only displayed.

- CLOCK
- ALARM LIST (displays alarms set)
- INTERNAL VALUES (displays real-time data)
- SERVICE
- LANGUAGES









To access the various procedures, touch the screen near the information/function required.

10.2 Setting the time, date and day of the week

1. Access the CLOCK menu by touching the corresponding line.
2. Touch  repeatedly until the green rectangle shows the desired value.
2. To set a value use the  or  keys or the slide-bar.

- To save, press the  key.
- To exit the procedure without making any changes, press the  key.

10.3 Setting configuration parameters

1. Ensure that no procedure is in progress.
2. Access the SERVICE menu by touching the corresponding line.
4. Touch  or  to set password "-19".
5. Touch  to confirm.
6. Touch  or  to scroll through the parameters.
7. Touch the desired parameter.
8. Touch  or  or drag the slide-bar to set the value:
 - To save, touch the  key.
 - To exit the procedure without making any changes, touch the  key.

10.4 Setting the language

1. Access the LANGUAGES menu by touching the corresponding line.
2. Touch the screen on the required language. The screen will immediately display the chosen language, with no need to press other keys to confirm it.

10.5 List of configuration parameters

The table below describes the configuration parameters of the device.

PARAM.	MIN.	MAX.	U.M.	DEF.	ANALOGUE INPUTS
P0	0	1	- - -	0	Type of probe 0 = J thermocouple (only for J/K versions) 1 = K thermocouple (only for J/K versions)
P1	0	1	- - -	0	Temperature measurement unit (1) 0 = °C 1 = °F
P2	0	1	- - -	0	Function type 0 = <u>WITH 1 ANALOGUE INPUT</u> (chamber probe, with separate management of the top and floor heating by setting the percentage of power delivered to the top and floor heaters) 1 = <u>WITH 2 ANALOGUE INPUTS</u> (top and floor probes, with separate temperature management for the top and the floor, setting 2 different temperature setpoints: one for the top heaters and one for the floor heaters)
P3	0	3	- - -	0	Enable steam injection activation mode 0 = <u>MANUAL</u> – steam injection will be enabled if the steam generator is switched on 1 = <u>REMOTE</u> – steam injection will be enabled if the steam generator is switched on and if the multi-purpose input is activated (until the input is deactivated; only if i5 = 1) 1 = <u>THERMOSTATIC</u> – steam injection will be enabled if the steam temperature regulation is activated and the steam temperature is above t1 - t3. 3 = <u>DISABLED</u> – steam injection and generation are disabled and the appropriate menu is NOT visible
CA1	-25/-50	25/50	°C/°F (2)	0	top probe offset
CA2	-25/-50	25/50	°C/°F (2)	0	floor probe offset
CA3	-25/-50	25/50	°C/°F (2)	0	Steam probe offset
PARAM.	MIN.	MAX.	U.M.	DEF.	MAIN REGULATOR
r0	1	99	°C/°F (2)	5	With ON-OFF regulation (r13=0): If P2 = 0, working setpoint differential If P2 = 1, top and floor working setpoint differential With ON-OFF regulation (r13=1 and P2=1): top and floor setpoint proportional band
r1	0	r2	°C/°F (2)	0	If P2 = 0, minimum working setpoint If P2 = 1, minimum top setpoint
r2	r1	999	°C/°F (2)	300	If P2 = 0, maximum working setpoint If P2 = 1, maximum top setpoint
r3	r1	r2	°C/°F (2)	130	Working/top setpoint
r4	0	r5	°C/°F (2)	0	Only if P2 = 1, minimum floor setpoint
r5	r4	999	°C/°F (2)	300	Only if P2 = 1, maximum floor setpoint
r6	r4	r5	°C/°F (2)	130	Floor setpoint
r7	0	1	- - -	0	Enables constraint between power delivered to the top and power delivered to the floor (only P2 = 0)

					<p>0 = NO 1 = YES – the setting for the power delivered to the top causes automatic adaptation of the power delivered to the floor, and vice-versa, so as to guarantee that the sum of the two power values is always 100</p>
r8	1	999	s	80	<p>If P2 = 0, cycle time for switch-on of the top and floor outputs If P2 = 1, cycle time for switch-on of the top and floor outputs during the energy-saving function (or PI cycle time only if r9 = 1)</p>
r9	0	1	---	0	<p>Type of temperature regulation 0 = ON-OFF regulation 1 = PI (Proportional-Integral), <u>ONLY FOR 2-PROBE REGULATION</u></p>
r10	1	240	s	10	Minimum on/off duration of the output for temperature regulation (not under 10 seconds in model V318 with electro-mechanical relays)
r11	0	240	min	30	<p>Integral time (only valid if r9 = 1) N.B. with r11=0: only proportional regulation</p>
PARAM.	MIN.	MAX.	U.M.	DEF.	MISCELLANEOUS
c0	-1	120	s	15	<p>Duration of buzzer activation on completion of the cooking cycle -1 = until manually silenced</p>
c1	0	1	- - -	0	Buzzer activation (for 1 second) at the end of a cooking cycle phase
c2	0	240	min	60	Time that has to pass if the device is not operated (from activation of the "weekly programmed switch-on" function) in order for it to switch off
c3	0	99	°C/°F (2)	10	<p>Temperature above which the temperature detected by the chamber probe cannot be displayed (referring to the working setpoint, i.e. "working setpoint + c3") 0 = function absent</p>
c4	0	99	°C/°F (2)	10	<p>Temperature under which the temperature detected by the chamber probe cannot be displayed (referring to the working setpoint, i.e. "working setpoint - c4") 0 = function absent</p>
c5	0	1	- - -	0	<p>Enable the "weekly programmed switch-on" function 0 = NO 1 = YES</p>
c6	0	1	- - -	0	<p>Activation of the "rapid heating" function when the device is switched on (only for 1-probe operation) 0 = NO 1 = YES</p>
c7	0	999	°C/°F (2)	150	<p>Chamber temperature above which the "rapid heating" function is interrupted (only for 1-probe operation) 0 = THE FUNCTION IS INTERRUPTED WHEN THE WORKING SETPOINT IS REACHED</p>
c8	0	240	min	60	<p>Maximum duration of the energy-saving function 0 = infinite duration (until manual deactivation) N.B. only applies if the energy-saving function has not been activated or kept active by the digital input (see i7)</p>
c9	0	100	%	50	<p>Percentage reduction in the duration of the top and floor switch-ons during the energy-saving function. <u>ONLY APPLIES FOR 1-PROBE OPERATION. IT CAN ALSO BE SET USING THE QUICK PROCEDURE</u></p>

PARAM.	MIN.	MAX.	U.M.	DEF.	STEAM INJECTION
t0	0	1	- - -	1	MANUAL steam injection activation mode 0 = For <u>Ton + PERSISTENCE</u> - pressing and releasing the MANUAL STEAM INJECTION key will cause steam injection for the T on time or for the length of time the key is pressed 1 = <u>PERSISTENCE</u> - pressing and releasing the MANUAL STEAM INJECTION key will cause steam injection for the length of time the key is pressed
t1	0	500	°C/°F	100	Steam setpoint; see also t2 (only if P3 = 2)
t2	0	99	°C/°F	5	t1 differential (only if P3 = 2)
t3	0	999	°C/°F	50	Steam temperature below which steam injection is disabled (relative to t1, where "t1 - t3"; only if P3 = 2); Steam injection is enabled once the steam temperature has reached the parameter t1 setting.
t4	0	1	- - -	1	Enables cyclical steam injection when the cooking timer starts up. 0 = NO 1 = YES - cyclical steam injection will be activated when the cooking timer starts up.
t5	0	1	- - -	1	Enables constraint between cyclical steam injection and the cooking timer stop. 0 = NO 1 = YES - when the cooking timer stops, cyclical steam injection will be deactivated; press and release the AUTO key to reactivate it.
t6	0	1	- - -	0	Automatic steamer switch-on when the oven is switched on 1 = YES - on moving from STAND-BY to ON the steamer starts up automatically.
PARAM.	MIN.	MAX.	U.M.	DEF.	TEMPERATURE ALARMS
A0	1	99	°C/°F (2)	10	A1 differential
A1	0	500	°C/°F (2)	0	Temperature above which the maximum temperature alarm is raised (referring to the temperature detected by the chamber probe or the top and floor temperature). See also A0 and A3
A2	0	240	min	0	Maximum temperature alarm delay
A3	0	2	- - -	0	Type of maximum temperature alarm 0 = alarm absent 1 = absolute (A1) 2 = relative to the working setpoint ("working setpoint + A1")
A4	0	80/175	°C/°F (2)	70	Temperature above which the working temperature alarm is raised (referring to the working temperature of the control module) 0 = alarm absent
A5	0	240	min	240	Duration of a power failure during the cooking cycle sufficient to interrupt it 0 = Always off
PARAM.	MIN.	MAX.	U.M.	DEF.	DIGITAL INPUTS
i0	0	1	- - -	0	Door switch input contact type 0 = normally open (input active with contact closed) 1 = normally closed (input active with contact open)
i1	0	1	- - -	0	Multi-purpose input 1 contact type

					<p>0 = normally open (input active with contact closed) 1 = normally closed (input active with contact open)</p>
i2	0	1	- - -	0	<p>Safety thermal switch input type</p> <p>0 = normally open (input active with contact closed) 1 = normally closed (input active with contact open)</p>
i3	0	1	- - -	0	<p>Multi-purpose input 2 contact type</p> <p>0 = normally open (input active with contact closed) 1 = normally closed (input active with contact open)</p>
i4	0	2	- - -	2	<p>Effect caused by activation of the door switch input</p> <p>0 = no effect 1 = <u>SWITCH ON THE SUCTION HOOD</u> - the suction hood is switched on 2 = <u>SWITCH ON THE SUCTION HOOD, SWITCH OFF THE TOP AND FLOOR OUTPUTS AND DISABLE STEAM INJECTION</u> - the suction hood will be switched on, the top and floor outputs switched off and steam injection disabled, until the input is deactivated.</p>
i5	0	2	- - -	1	<p>Effect caused by activation of the multi-purpose input 1</p> <p>0 = no effect 1 = <u>ENABLE STEAM INJECTION</u> - steam injection is enabled, until the input is deactivated, only if P3 = 1) 2 = <u>SWITCH OFF THE DEVICE</u> - the device is switched off, until the output is deactivated.</p>
i6	0	120	s	5	Thermal switch input alarm signal delay
i7	0	3	- - -	1	<p>Effect caused by activation of the multi-purpose input 2</p> <p>0 = no effect 1 = <u>POWER CONSUMPTION PROTECTION</u> - steam injection is disabled, the steam generator, the top and floor outputs are switched off, the device displays the words PEAK CONSUMPTION and the buzzer is activated, until the input is deactivated. 2 = <u>ENERGY-SAVING FUNCTION ACTIVATED</u> - the energy-saving function is activated, until the input is deactivated. 3 = <u>TYPE 1 BURNER FAULT INPUT</u> - steam injection is disabled, the steam generator, the top and floor outputs are switched off, the device displays the words BURNER FAULT and the buzzer is activated, until the input is deactivated. It is possible to reset the alarm using the appropriate key that will appear to the side of the alarm, which activates, if enabled by u5, the relative relay output for 5 seconds, resetting the gas control unit and restoring normal function. 4 = <u>TYPE 2 BURNER FAULT INPUT</u> - the steam generator, the top and floor outputs are not switched off, the device displays the words BURNER FAULT and the buzzer is activated, until the input is deactivated. It is possible to reset the alarm using the appropriate key that will appear to the side of the alarm, which activates, if enabled by u5, the relative relay output for 5 seconds, resetting the gas control unit and restoring normal function.</p>
PARAM.	MIN.	MAX.	U.M.	DEF.	DIGITAL OUTPUTS
u0	0	1	- - -	0	<p>Venting output contact type</p> <p>0 = normally open (venting open with contact closed)</p>

					1 = normally closed (venting open with contact open)
u1	0	1	---	0	Load managed by venting output 0 = <u>ON-OFF SOLENOID VALVE</u> 1 = <u>MOTORISED SOLENOID VALVE</u> - with this setting parameters u2, u3 and u4 are relevant
u2	0	600	ds (s/10)	120	Duration of the venting output stoppage from the end of the short pulse for opening the vent and from the end of the long pulse for closing it (only if u1 = 1). See also u3 and u4
u3	0	600	ds (s/10)	10	Duration of the short pulse for opening the vent (only if u1 = 1). See also u2 and u4
u4	0	600	ds (s/10)	30	Duration of the long pulse for closing the vent (only if u1 = 1). See also u2 and u3
u5	0	3	---	0	Load managed by digital output K5 0 = <u>ELECTRONICS COMPARTMENT FAN</u> - with this setting parameter u6 is relevant 1 = <u>ON/OFF</u> 2 = <u>ACOUSTIC SIGNAL</u> 3 = <u>BURNER FAULT RESET</u>
u6	20/65	65/150	°C/°F (2)	60	Temperature above which the electronics compartment fan is switched on with the oven in stand-by mode (referring to the operating temperature of the control module). See also F7
u7	1	99	°C/°F (2)	10	u6 differential
PARAM.	MIN.	MAX.	U.M.	DEF.	SERIAL NETWORK
LA	1	247	---	247	Device address
Lb	0	3	---	2	Baud rate 0 = 2,400 baud 1 = 4,800 baud 2 = 9,600 baud 3 = 19,200 baud
LP	0	2	---	2	Parity 0 = none 1 = odd 2 = even
PARAM.	MIN.	MAX.	U.M.	DEF.	OTHERS
e0	0	1	---	1	EVCO Splash enabled 0 = NO 1 = YES
e1	0	1	---	0	Keypad lock 0 = disabled 1 = automatic (after 60 seconds)
e2	0	1	---	0	STAND-BY background 0 = bread-baking background 1 = pizzeria background
e3	0	240	s	60	Screen saver 0 = No screen saver

11 USING THE USB PORT

11.1 Initial information

The USB port makes possible the following operations.

- Upload and download of the settings in the recipes of the "My Recipes" function and in the working cycles of the "Special Cycles" function (known as "programs" from here on)
- Upload and download of the settings in the configuration parameters.

These operations are guaranteed by using the EVUSB4096M USB device.

Uploading operations are only possible if the firmware of the device from which it originates and the firmware of the destination device are the same.

11.2 Uploading the program settings

The program settings can be uploaded as follows.

1. Ensure that the device is switched off and that no procedure is in progress.
2. Insert a USB flash drive containing a text document named "prog.bin" in the USB port of the device and wait for a few seconds.
3. Touch "UPLOAD PROGRAMS".
4. Touch  to confirm.
5. When the upload has finished remove the USB flash drive from the port of the device.

11.3 Downloading the program settings

The program settings can be downloaded as follows.

1. Ensure that the device is switched off and that no procedure is in progress.
2. Insert a USB flash drive in the USB port of the device and wait for a few seconds.
3. Touch "DOWNLOAD PROGRAMS".
4. Touch  to confirm; a file "prog.bin" will be generated to be used for the upload in further controllers.

11.4 Uploading the settings in the configuration parameters

The program settings can be uploaded as follows.

1. Ensure that the device is switched off and that no procedure is in progress.
2. Insert a USB flash drive containing a text document named "param.bin" in the USB port of the device and wait for a few seconds.
3. Touch "UPLOAD PARAMETERS".
4. Touch  to confirm.
5. When the upload has finished remove the USB flash drive from the port of the device.

11.5 Downloading the settings in the configuration parameters

The program settings can be downloaded as follows.

1. Ensure that the device is switched off and that no procedure is in progress.
2. Insert a USB flash drive in the USB port of the device and wait for a few seconds.
3. Touch "DOWNLOAD PARAMETERS".
4. Touch  to confirm; a file "param.bin" will be generated to be used for the upload in further controllers.

12 Alarm management

If an alarm situation happens, the buzzer is activated and on the ON screen, the alarm icon below will appear in place of the clock field.



Touch the key once to silence the buzzer, touch it a second time to access the menu screen displaying the alarm in progress and to reset. An example of an active alarm display is given below.

TERMOSTATO SICUREZZA

If an alarm can be reset manually, the following key appears. Press it to activate the reset alarm procedure.



The table below shows the meaning of the device's various alarm codes.

ALARM CODE	DESCRIPTION
RTC ALARM	Rtc alarm To correct - Set the date and time
Chamber/top probe ALARM	Chamber/top probe alarm To correct - Check the type of probe; see parameter P0 - Check the device-probe connection - Check the chamber temperature Main results - The temperature regulation output will be switched off
Floor probe ALARM	Floor probe alarm To correct - As in the previous case, but relating to the floor Main results - The temperature regulation output will be switched off
Steam probe ALARM	Steam probe alarm To correct - As in the previous case, but working on the steam probe Main results - The steamer management output will be switched off
Power failure ALARM	Power failure alarm To correct - Check the device-power supply connection. Main results - If the alarm is raised when the device is switched on or off, the device will switch off once the power is restored - If the alarm is raised during a cooking cycle and the interruption lasts for a shorter time than that set by parameter A5, when power is restored the cycle will be resumed from the start of the phase in which the power failed (if the interruption lasts longer than the time set by parameter A5, the cycle will be interrupted when power is restored).
No connection ALARM	User interface-control module communication alarm To correct - Check the user interface-control module connection. Main results - The loads will be deactivated
Basic module compatibility ALARM	User interface-control module compatibility alarm To correct

	<ul style="list-style-type: none"> - Check the user interface-control module FIRMWARE versions. <p>Main results</p> <ul style="list-style-type: none"> - The loads will be deactivated
Temperature ALARM	<p>Top/floor maximum temperature alarm</p> <p>To correct</p> <ul style="list-style-type: none"> - Check the temperature detected by the top/floor probe. See parameters A0, A1 and A3 <p>Main results</p> <ul style="list-style-type: none"> - No effect
High board temperature ALARM	<p>Operating temperature alarm</p> <p>To correct</p> <ul style="list-style-type: none"> - Check the operating temperature of the control module; see parameter A4 <p>Main results</p> <ul style="list-style-type: none"> - The vent will open, the electronics compartment fan will switch on, the top and floor outputs and the steam generator will be switched off
	<p>door switch input alarm</p> <p>To correct</p> <ul style="list-style-type: none"> - Check the cause of the input activation; see parameter i0 <p>Main results</p> <ul style="list-style-type: none"> - See parameter i4
Safety thermostat ALARM	<p>Safety thermostat input alarm</p> <p>To correct</p> <ul style="list-style-type: none"> - Check the cause of the input activation; see parameter i2 <p>Main results</p> <ul style="list-style-type: none"> - The top and floor outputs and the steam generator will be switched off
Peak consumption ALARM	<p>Power input alarm</p> <p>To correct</p> <ul style="list-style-type: none"> - Check the cause of the input activation; see parameter i3 <p>Main results</p> <ul style="list-style-type: none"> - The top and floor outputs and the steam generator will be switched off
Burner fault ALARM	<p>Burner fault alarm</p> <p>To correct</p> <ul style="list-style-type: none"> - Check that the burner is working properly; see parameter i3 <p>Main results</p> <ul style="list-style-type: none"> - See parameter i7

13 ACCESSORIES

13.1 Safety transformer (ECTSFD004)

The transformer can power the user interface.



13.2 Non-optoisolated RS-485/USB serial interface (EVIF20SUXI)

The interface enables the device to be connected to the Parameters Manager set-up software system.



13.3 USB plug for panel installation (081200002)

The plug makes the USB communications port of the device more accessible.

To connect the device to the plug, connecting cable 0810500018 or 0810500020 must be used (to be ordered separately).



13.4 Connecting cables (0810500018/0810500020)

These cables are used to connect the USB plug for panel installation 081200002 to the device.

Cable 0810500018 is 2 m long; cable 0810500020 is 0.5 m long.



13.5 4GB USB flash drive (EVUSB4096M)

The flash drive makes it possible to upload and download the settings and the data recorded by the device.



14 TECHNICAL SPECIFICATIONS

14.1 Technical specifications

Purpose of the control device	Function controller	
Construction of the control device	Built-in electronic device	
Container	user interface	control module
	Open frame board behind glass.	Open frame board
Category of heat and fire resistance	D	
Measurements	user interface	control module
	Vcolor 318M/328M: 118.0 x 166.0 x 35.0 mm (4.645 x 6.535 x 1.377 in; L x H x D). Vcolor 318L/328L: 156.0 x 216.0 x 50.0 mm (6.141 x 8.503 x 1.968 in; L x H x D).	166.0 x 116.0 x 44.0 mm (6.535 x 4.566 x 1.732 in; L x H x D).
Mounting methods for the control device	user interface	control module
	Installed from behind using threaded studs.	On a flat surface with spacers.
Degree of protection	user interface	control module
	IP65 (front)	IP00
Connection method	user interface	control module
	Plug-in screw terminal blocks for wires up to 1.5 mm ² , type A female USB connector (USB port).	Plug-in screw terminal blocks for wires up to 2.5 mm ²
	Maximum permitted length for connection cables <ul style="list-style-type: none"> - user-interface-control module connection: 10 m (32.8 ft) - Power supply: 10 m (32.8 ft) - Analogue inputs: 10 m (32.8 ft) - Digital inputs: 10 m (32.8 ft) - Digital outputs: 100 m (328 ft) - RS-485 MODBUS port: 1,000 m (3,280 ft) - USB port: 1 m (3.28 ft). 	
Operating temperature	From 0 to 55 °C (from 32 to 131 °F)	
Storage temperature	From -10 to 70 °C (from 14 to 158 °F).	
Operating humidity	Relative humidity without condensate from 10 to 90%	
Pollution status of the control device	2.	
Environmental standards	<ul style="list-style-type: none"> - RoHS 2011/65/EC - WEEE 2012/19/EU - REACH (EC) Regulation 1907/2006. 	
EMC standards	<ul style="list-style-type: none"> - EN 60730-1 - IEC 60730-1. 	

Power supply	user interface	control module
	Vcolor 318M/328M: provided by the control module Vcolor 318L/328L: 12 VAC 20 VA.	115... 230 VAC ($\pm 15\%$), 50/60 Hz (± 3 Hz), 10 VA max.
Rated impulse-withstand voltage	4 KV	
Over-voltage category	III.	
Software class and structure	A.	
Clock	Built-in (with secondary lithium battery).	
	Clock drift: ≤ 60 s/month at 25 °C (77 °F)	
	Clock battery autonomy in the absence of a power supply: > 6 months at 25 °C (77 °F)	
	Clock battery charging time: 24h (the battery is charged by the power supply of the device).	
Analogue inputs	3 inputs (top probe, floor probe and steam probe), can be set by the configuration parameter for the J/K thermocouples.	
	<p>Thermocouple J type analogue inputs</p> <p>Sensor type: iron/constantan.</p> <p>Measurement field: from -50 to 700 °C (from -58 to 1,292 °F).</p> <p>Resolution: 1 °C (1 °F).</p> <p>Protection: none.</p> <hr/> <p>Thermocouple K type analogue inputs</p> <p>Sensor type: chromel/alumel.</p> <p>Measurement field: from -50 to 1,100 °C (from -58 to 2,012 °F).</p> <p>Resolution: 1 °C (1 °F).</p> <p>Protection: none.</p>	
Digital inputs	4, dry contact (door switch, thermal switch, multi-purpose 1, multi-purpose 2).	
	<i>Dry contact</i>	
	Contact type	5 VDC, 2 mA.
	Power supply:	none

Digital outputs	<p>8 outputs (electro-mechanical relays):</p> <ul style="list-style-type: none"> - 1 8 A res. @ 250 VAC type SPST (K6) output for managing the top temperature regulation (only Vcolor 318M/318L) - 1 8 A res. @ 250 VAC type SPST (K7) output for managing the floor temperature regulation (only Vcolor 318M/318L) - 1 8 A res. @ 250 VAC type SPDT (K1) output for managing steam injection - 1 8 A res. @ 250 VAC type SPST (K3) output for managing the vent - 1 8 A res. @ 250 VAC type SPST (K2) output for managing the steam generation - 1 16 A res. @ 250 VAC type SPDT (K8) output for managing the chamber light* - 1 16 A res. @ 250 VAC type SPST (K4) output for managing the suction hood - 1 8 A res. @ 250 VAC type SPDT (K5) configurable output (for factory settings, on/stand-by) <p>* The relays do not manage LED and fluorescent lamps</p> <p>2 12 V, 30 mA outputs (solid-state relay command)</p> <ul style="list-style-type: none"> - 1 output for managing top temperature regulation (only Vcolor 328M/328L) - 1 output for managing floor temperature regulation (only Vcolor 328M/328L)
Displays	<p>5 or 7-inch TFT touch-screen graphic display, 16K colours, 800 x 480 pixel resolution. The presence of point defects on the display falls within the tolerance limits as provided by applicable standards.</p>
Type 1 or Type 2 Actions	Type 1.
Additional features of Type 1 or Type 2 actions	C.
Communications ports	<p>2 ports:</p> <ul style="list-style-type: none"> - 1 RS-485 MODBUS port - 1 USB port
Warning and alarm buzzer	Built-in

Vcolor 318/328

Top-floor controllers for bread and pizza ovens, with a 5 or 7-inch colour TFT touch-screen graphic display, in split version that can be built into the unit.

Installer manual ver. 2.0

GA - 23/18

Code 144VC318E204

This document and the solutions contained therein are the intellectual property of EVCO and thus protected by the Italian Intellectual Property Rights Code (CPI). EVCO imposes an absolute ban on the full or partial reproduction and disclosure of the content other than with the express approval of EVCO. The customer (manufacturer, installer or end-user) assumes all responsibility for the configuration of the device. EVCO accepts no liability for any possible errors in this document and reserves the right to make any changes, at any time without prejudice to the essential functional and safety features of the equipment.



EVCO S.p.A.
Via Feltre 81, 32036 Sedico Belluno ITALY
Tel. 0437/8422 | Fax 0437/83648
info@evco.it | www.evco.it