

Vcolor 348 M & L

Controller for electric rotary ovens for bread and pastry-making, with a 5 or 7-inch colour TFT touch-screen graphic display, in split version that can be built into the unit.





Important

Read this document carefully before installation and before using the device and take all the prescribed precautions. Keep this document with the device for future consultation.

Only use the device in the ways described in this document.

Do not use the device as safety device.



Disposal

The device must be disposed of according to local regulations governing the collection of electrical and electronic waste.

Index

1	1. INTRODUCTION	4	13.1	Activating expansion	28
1.1	Introduction	4	13.2	Electrical connection	28
1.2	Table listing the models available, their main features and purchasing codes	5	13.3	Application diagram	29
2	MEASUREMENTS AND INSTALLATION	7	13.4	Operation	30
2.1	Vcolor 348M user interface measurements	7	13.5	Error management	30
2.2	Vcolor 348L user interface measurements	7	14	CONFIGURATION	31
2.3	User interface installation	8	14.1	Setting the time, date and day of the week	31
2.4	Control module measurements and installation	8	14.2	Setting configuration parameters	31
2.5	Installation precautions	9	14.3	List of configuration parameters	32
3	ELECTRICAL CONNECTION	10	15	USING THE USB PORT	38
3.1	Vcolor 348M electrical connection	10	15.1	Initial information	38
3.2	Vcolor 348L electrical connection	12	15.2	Uploading the program settings	38
3.3	Precautions for electrical connection	16	15.3	Downloading the program settings	38
4	DESCRIPTION	17	15.4	Uploading the settings in the configuration parameters	38
4.1	User interface description	17	15.5	Downloading the settings in the configuration parameters	38
4.2	Control module description	19	16	ALARMS	39
5	FIRST-TIME USE	21	16.1	Alarms	39
5.1	First-time use	21	17	ACCESSORIES	42
6	MANAGING THE LOADS	22	17.1	Non-optoisolated RS-485/USB serial interface	42
6.1	Initial information	22	17.2	USB plug for panel installation	42
6.2	Temperature adjustment	22	17.3	0810500018/0810500020 connecting cables	42
6.3	Steam injection	22	17.4	EVUSB4096M 4GB USB flash drive	42
6.4	Venting	22	18	TECHNICAL SPECIFICATIONS	43
6.5	Chamber light	22	18.1	Technical specifications	43
6.6	Technical room fan	22			
6.7	Fan	22			
6.8	Fume reduction	23			
6.9	ROTOR management	23			
6.10	Suction hood	23			
7	USER INTERFACE	23			
7.1	Switching the device on and off	23			
7.2	Silencing the buzzer	23			
8	COOKING CYCLE	24			
8.1	Initial information	24			
8.2	Setting the cooking cycle	24			
9	"MY RECIPES" FUNCTION	25			
9.1	Initial information	25			
9.2	Saving a recipe	25			
9.3	Starting up a recipe	25			
9.4	Deleting a recipe	25			
10	"Weekly programmed switch-on" function	25			
10.1	Initial information	25			
10.2	Setting the "Weekly programmed switch-on" function	25			
10.3	Activating the "Weekly programmed switch-on" function	26			
11	OTHER FUNCTIONS	26			
11.1	View alarm status	26			
11.2	View process and machine status variables	26			
11.3	Setting the screen language	26			
12	BOILER EXPANSION	27			
12.1	Activating expansion	27			
12.2	Electrical connection	27			
12.3	Operation	27			
13	BURNER EXPANSION	28			

1 INTRODUCTION

1.1 Introduction

The **Vcolor 348** series is a range of stylish controllers for managing electric rotary ovens for bread and pastry-making.

Available in split version, the user interface can be built into the unit mechanically for optimum aesthetic effect. It consists of a 5-inch (Vcolor 348M) or 7-inch (Vcolor 348L) capacitive TFT touch-screen graphic display, 65K colours, 800 x 480 pixel resolution and guarantees IP65 protection, for easy cleaning.

It is capable of managing the fan in both "on/off" and modulating modes, in the latter case an external speed regulator is also necessary, with inversion of the fan direction.

It has a complete steam management system (generation, injection and venting) in both automatic and manual mode. Steam can be generated either directly or by way of an external boiler module that can also control charge and discharge (the steam generation mode may be a function of the chamber temperature).

The external burner module can manage gas ovens with atmospheric or pressure jet burners.

The user interface is installed from behind using threaded studs, making the display flush with the front.

1.2 Table listing the models available, their main features and purchasing codes

The table below lists the models available.

Models available	Vcolor 348
------------------	------------

The table below shows the main features of the device.

Items shown in quotation marks (" / ") indicate that the feature can be set using a configuration parameter.

Power supply	Vcolor 348
12 VAC	•
Analogue inputs (J/K or Pt 100, according to the model)	Vcolor 348
Chamber probe	•
Fume probe	•
Digital inputs (for normally open/normally closed contact)	Vcolor 348
Door switch	•
Rack rotation limit switch	•
Fan thermal switch (230 VAC)	•
Thermal switch (230 VAC)	•
Power consumption (230 VAC)	•
Analogue outputs	Vcolor 348
0-10 V (fan)	•
Digital outputs (electro-mechanical relays; A res. @ 250 VAC)	Vcolor 348
Chamber temperature adjustment	1 A
Venting	1 A
Direct steam injection	1 A
Chamber light	4 A
Technical room fan	1 A
Fan (1)	1 A
Suction hood	
Fan speed (for configuration in two-speed mode) (1)	1 A
Rack rotation	1 A
Not used	1 A
Not used	1 A
Not used	1 A
Not used	1 A
Communications ports	Vcolor 348
RS-485 MODBUS	•
USB	•
Other features	Vcolor 348
Clock	•

Alarm buzzer	•
Fan management in "on/off" at single or two-speed mode or in modulating mode	•
"Weekly programmed switch-on" function	•
"Programs" function	•

Notes

- (1) configurable for:
- fan management in "on/off" mode at single speed
 - fan management in "on/off" mode at two-speed
 - fan management in modulating mode

Optional extras

None

For more information see the section "TECHNICAL SPECIFICATIONS".

The table below shows the purchasing codes.

Purchasing codes	Vcolor 348M (control module + 5-inch user interface kit)
	EVCMC34DJ2E for J/K thermocouples
	EVCMC34DC2E Pt 100 2 wires
	Vcolor 348L (control module + 7-inch user interface kit)
	EVCLC34DJ2E for J/K thermocouples
EVCLC34DC2E Pt 100 2 wires	
	Optional
	EVCLE305XXE boiler module
	EVCLE302XXE burner module

For more models contact the EVCO sales network.

2 MEASUREMENTS AND INSTALLATION

2.1 Vcolor 348M user interface measurements

The pictures below show the measurements of the 5-inch user interface; measurements are expressed in mm (inches).

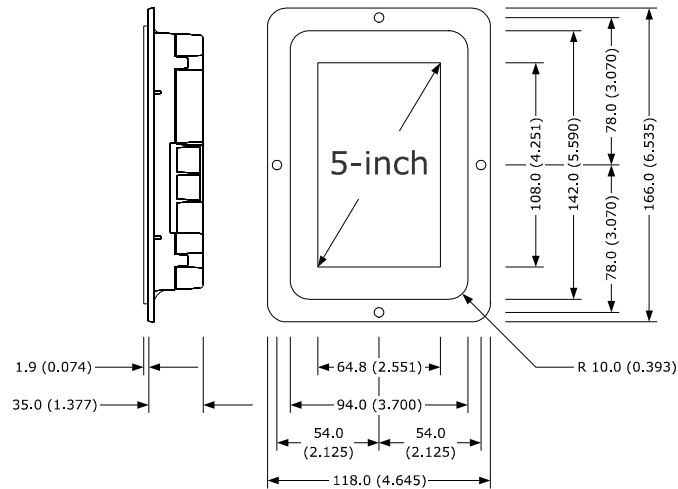

2.2 Vcolor 348L user interface measurements

The pictures below show the measurements of the 7-inch user interface; measurements are expressed in mm (inches).

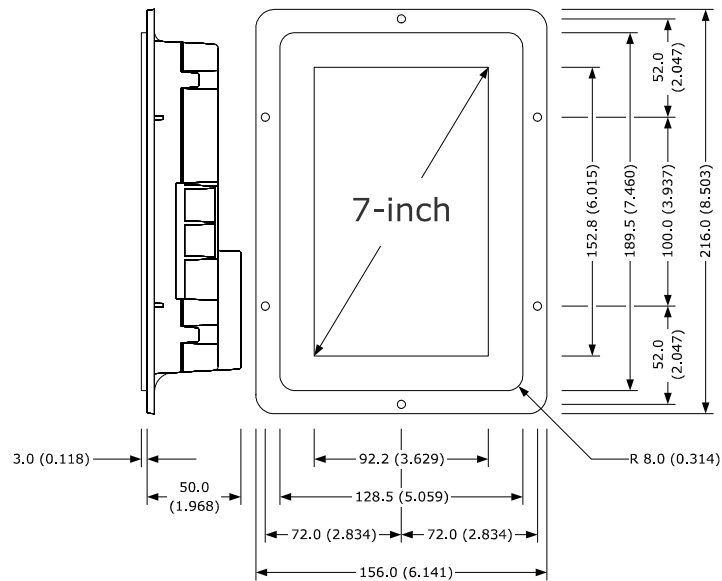

2.3 User interface installation

The picture below shows the installation of the device user interface.

The user interface is installed from behind using threaded studs, making the display flush with the front.

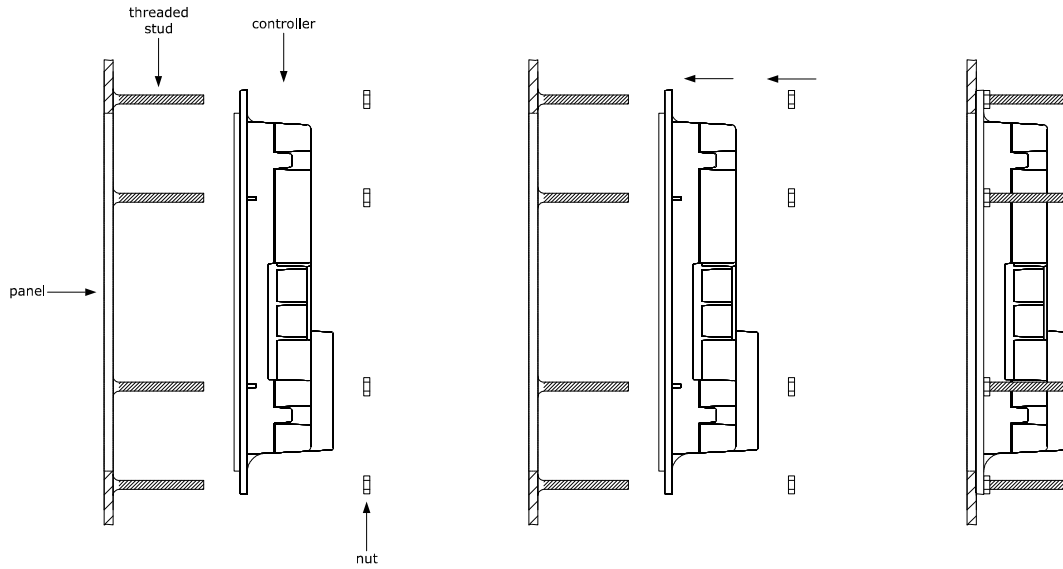

2.4 Control module measurements and installation

The pictures below show the measurements of the device control module; measurements are expressed in mm (inches).

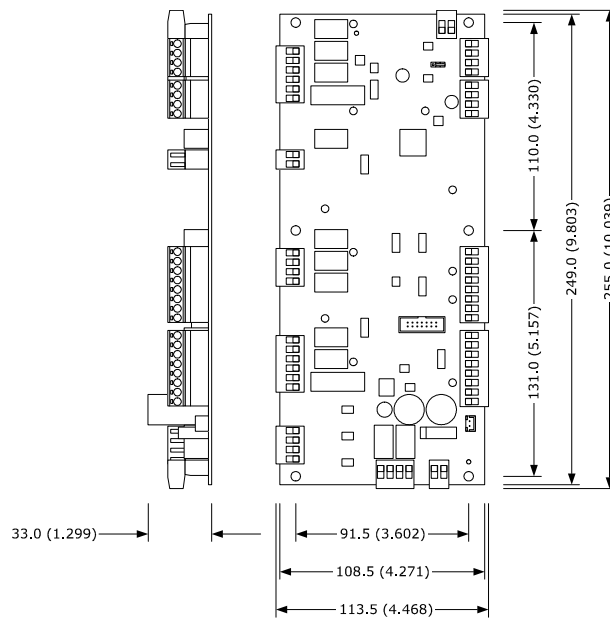

Installation is on a flat surface with spacers.

2.5 Installation precautions

- Ensure that the working conditions for the device (operating temperatures, humidity, etc.) are within the set limits. See the section TECHNICAL SPECIFICATIONS.
- Do not install the device close to heat sources (heaters, hot air ducts, etc.), equipment with a strong magnetic field (large diffusers, etc.), in places subject to direct sunlight, rain, damp, excessive dust, mechanical vibrations or shocks.
- Any metal parts close to the control module must be far enough away so as not to compromise the safety distance.
- In compliance with safety regulations, the device must be installed properly to ensure adequate protection from contact with electrical parts. All protective parts must be fixed in such a way as to need the aid of a tool to remove them
- ensure that the thermocouple is properly insulated from contact with metal parts or use already insulated thermocouples.

3 ELECTRICAL CONNECTION

3.1 Vcolor 348M electrical connection

The picture below shows the electrical connection of devices with a 5-inch user interface.

For more information on how to manage ventilation see subsequent pictures.

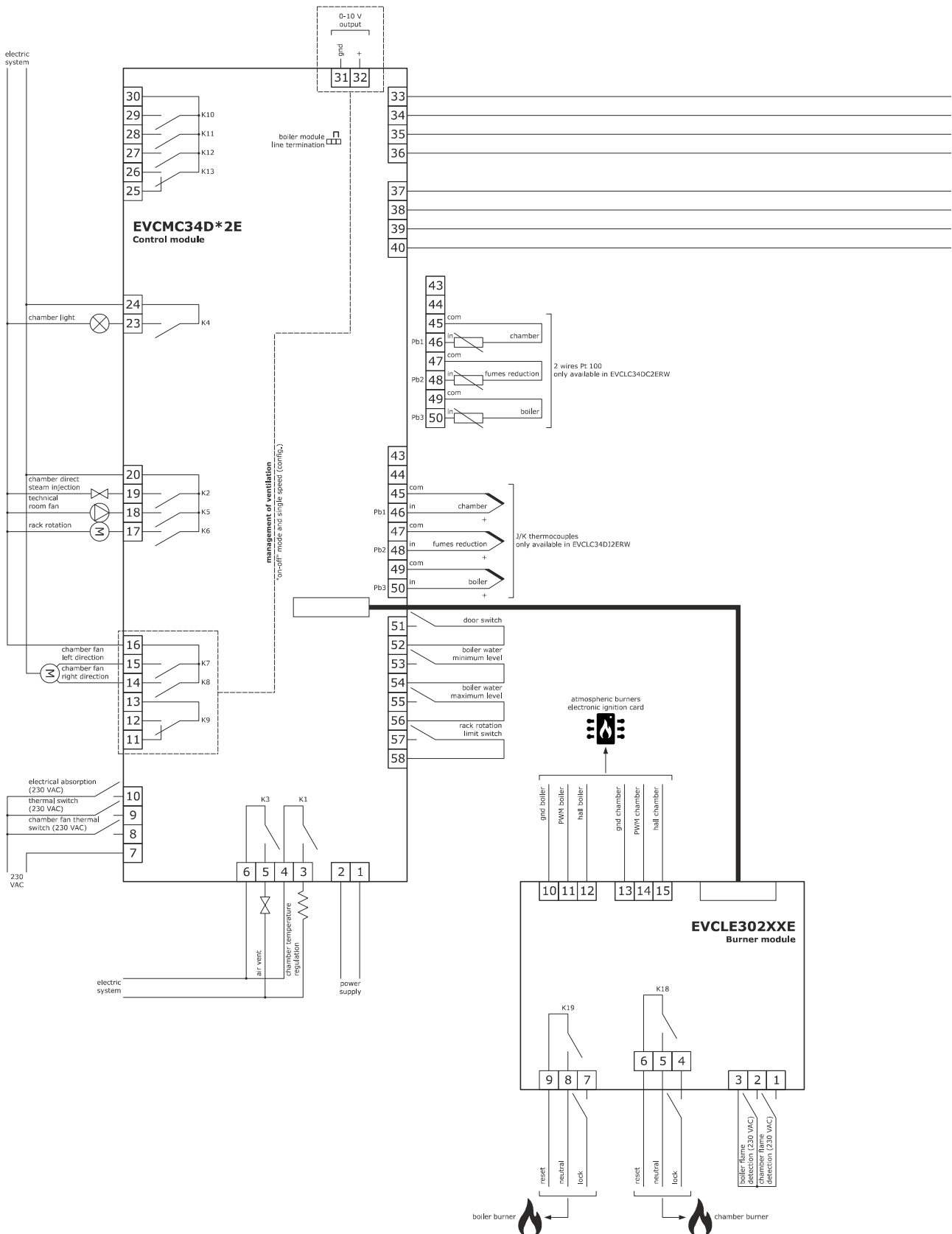

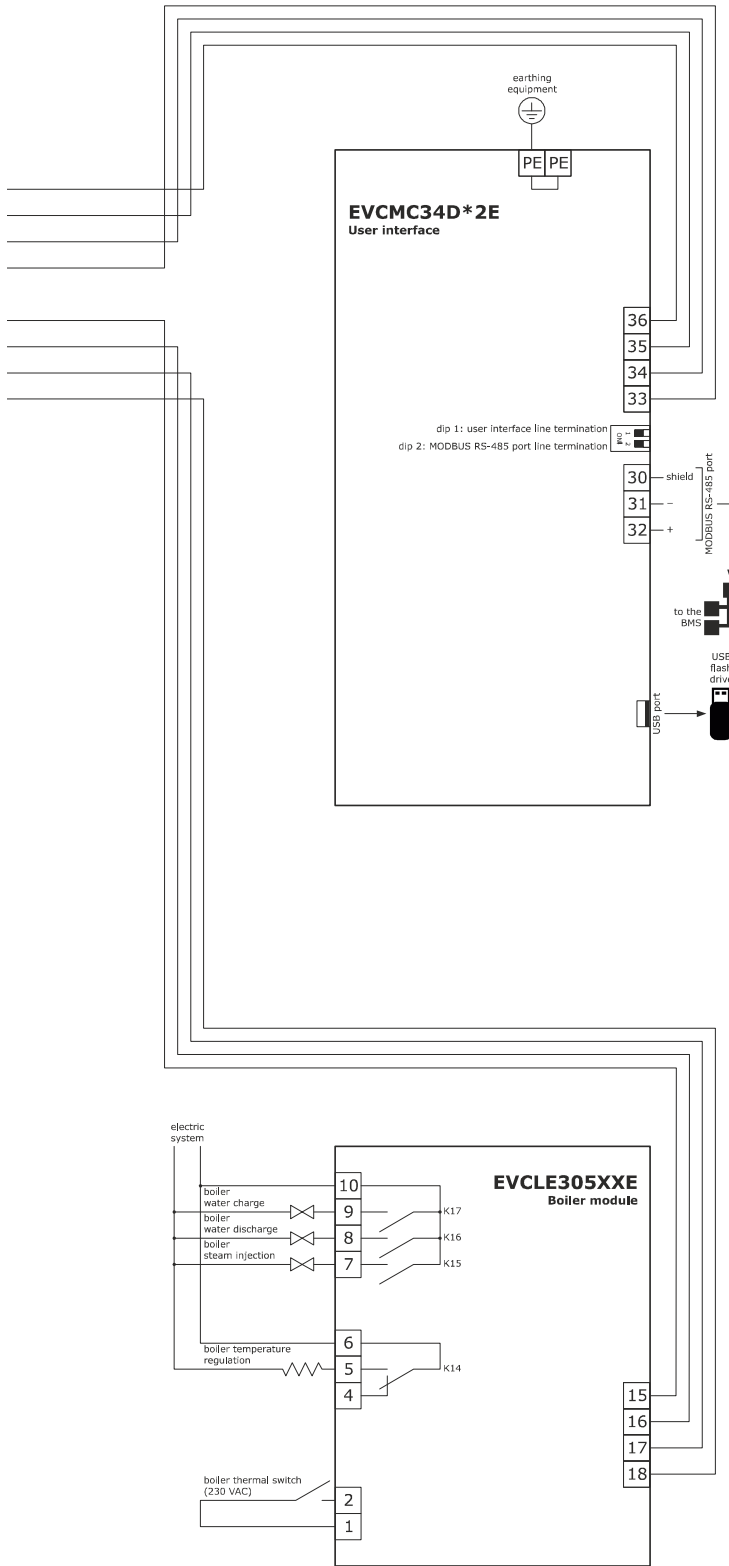

3.2 Vcolor 348L electrical connection

The picture below shows the electrical connection of the device with a 7-inch user interface.
 For more information on how to manage ventilation see subsequent pictures.

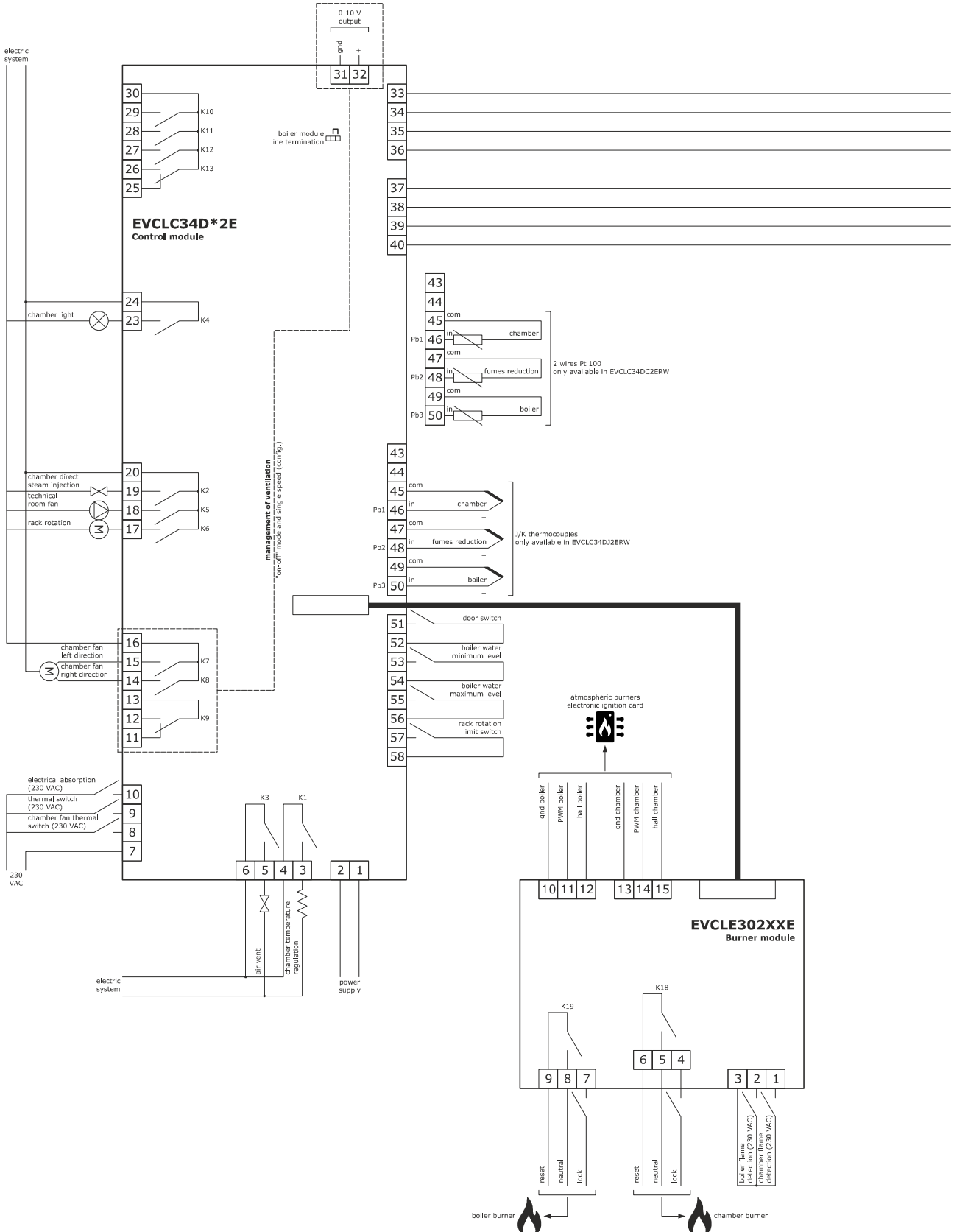

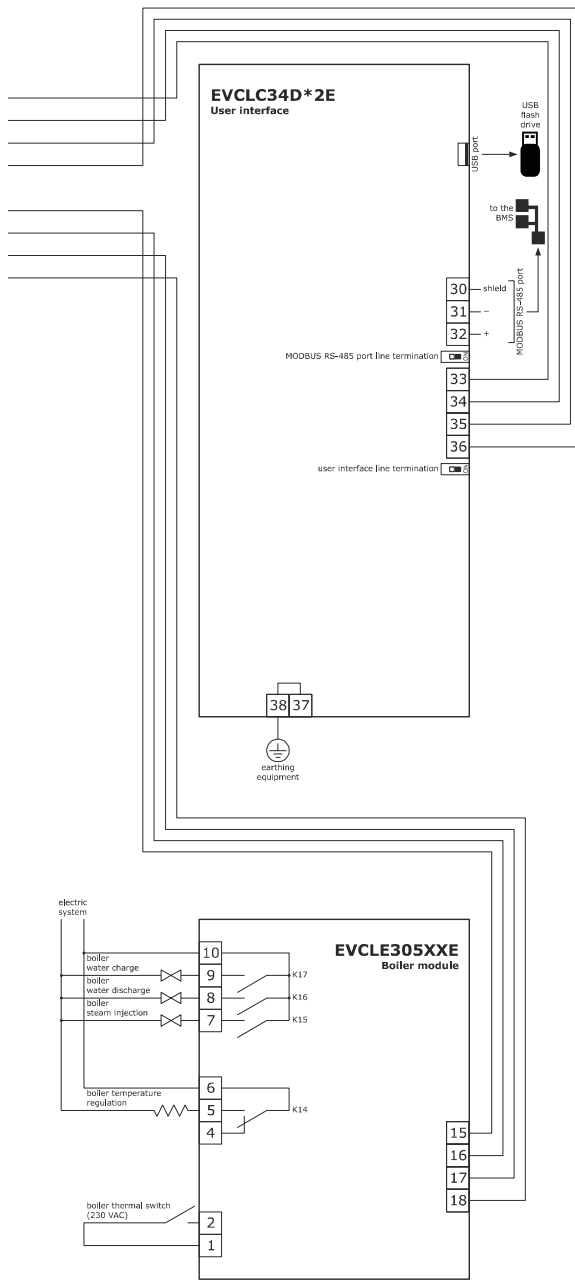

Fan management in "on/off" mode at single speed (parameter F0 = 0).

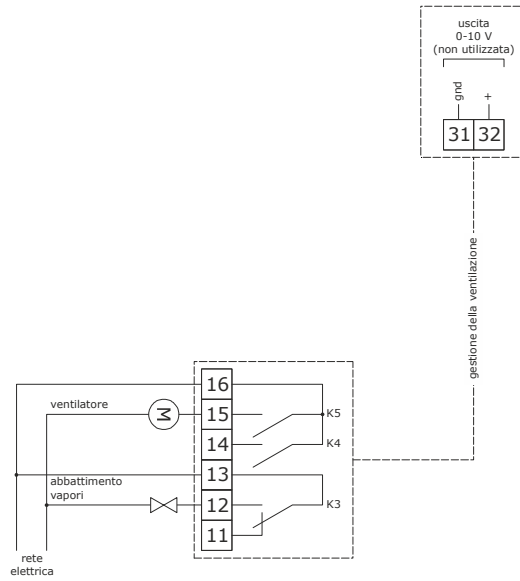

Fan management in "on/off" mode at two-speed (parameter F0 = 2).

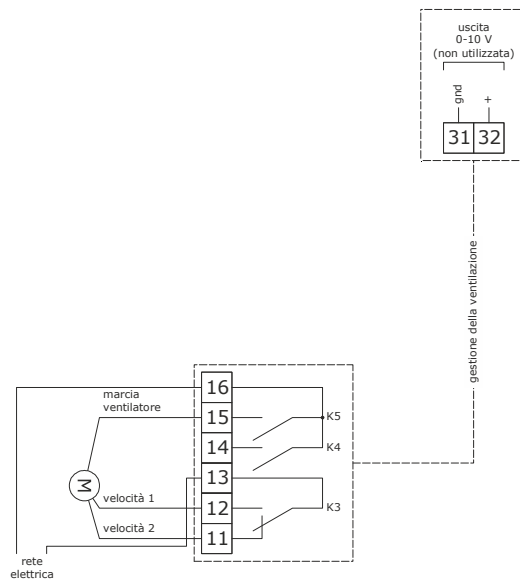

Fan management in modulating mode (parameter F0 = 3).

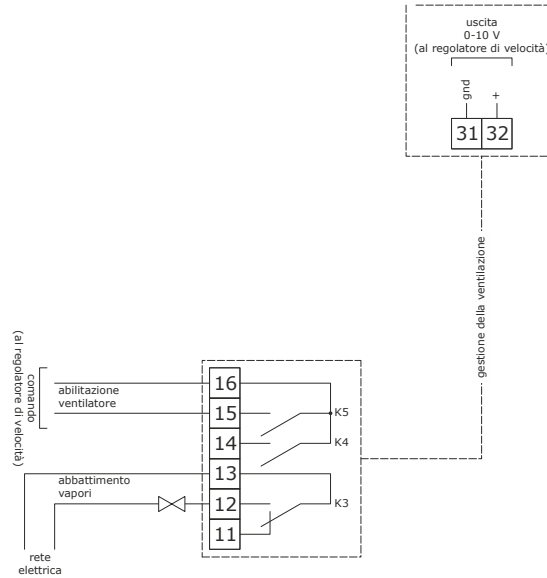

The RS-485 MODBUS port is the communications port with the following EVCO products:

- Parameters Manager set-up software system

The USB port is the communications port for uploading and downloading the device settings using an ordinary USB flash drive.

Example of connection of a motorised venting solenoid valve.

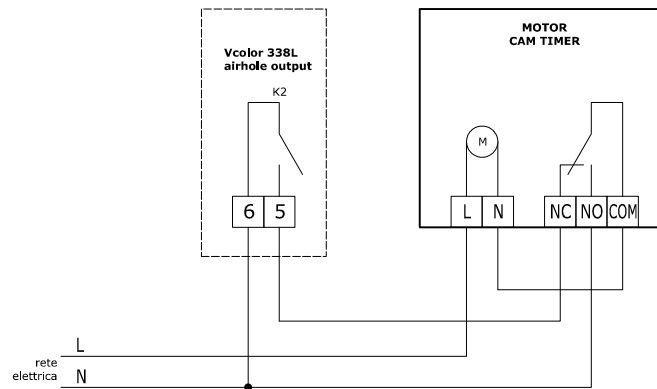

The diagram below shows functioning with the following parameters set.

u2 = 140 (14 seconds) pause time for cam to run

u3 = 10 (1 second) motor activation time for short milling output

u4 = 30 (3 seconds) motor activation time for long milling output

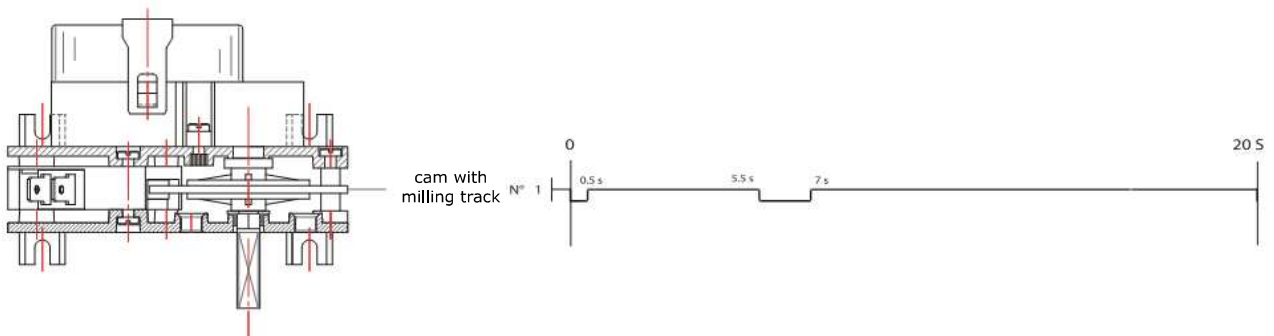

3.3 Precautions for electrical connection

- Do not use electric or pneumatic screwdrivers on the terminal blocks of the device.
- If the device has been moved from a cold to a warm place, the humidity may cause condensation to form inside. Wait about an hour before switching on the power.
- Make sure that the supply voltage, electrical frequency and power of the device correspond to the local power supply. See section 19 TECHNICAL SPECIFICATIONS.
- Disconnect the device from the power supply before doing any type of maintenance.
- Connect the power cables as far away as possible from those for the signal.
- To reduce reflections on the signal transmitted along the cables connecting the user interface to the control module it is necessary to fit a termination resistor
- For repairs and for further information on the device, contact the EVCO sales network.

4 DESCRIPTION

4.1 User interface description

The picture below shows the front view of the device user interface.

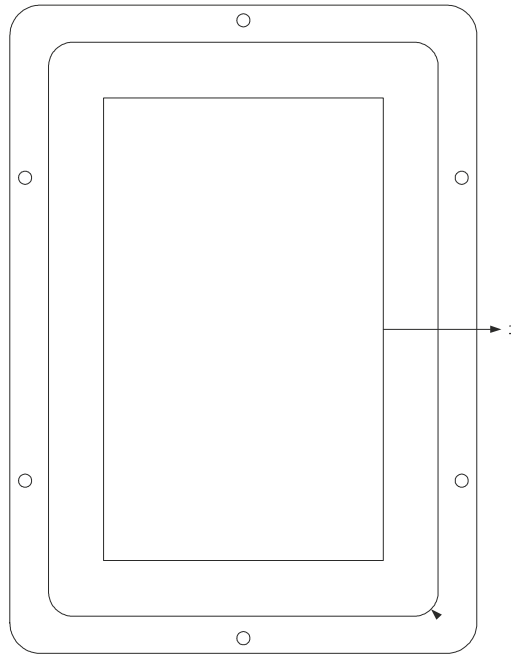

The table below describes the front parts of the device user interface.

PART	DESCRIPTION
1	display

The picture below shows the back view of the device user interface.

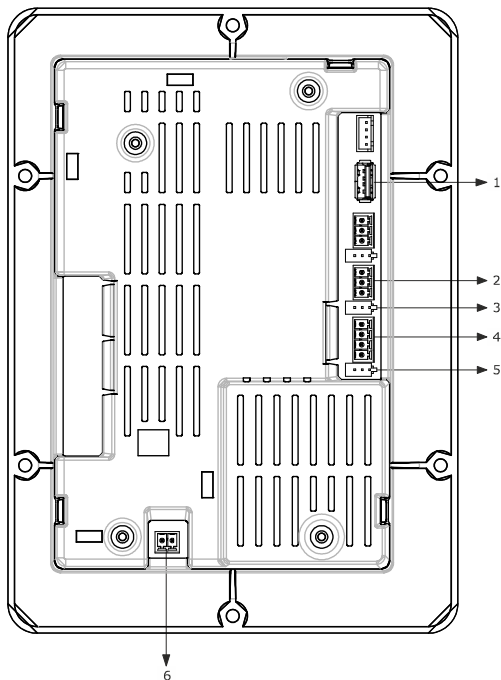

The table below describes the back parts of the device user interface.

PART	DESCRIPTION
1	USB port
2	MODBUS communications port
3	dip switch for the termination resistor for the RS-485 MODBUS port
4	communications port with the user interface (power supply)
5	dip switch
6	earthing

For more information see subsequent sections.

4.2 Control module description

The diagram below shows the appearance of the device control module.

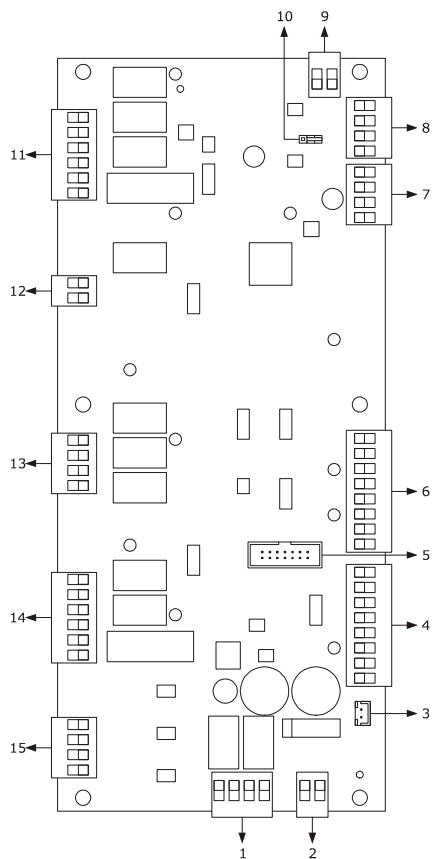

The table below describes the parts of the device control module.

PART	DESCRIPTION
1	K1 and K2 digital outputs
2	power supply
3	external buzzer output
4	digital inputs for dry contact
5	unused
6	analogue inputs
7	unused
8	communications port with the user interface
9	analogue output
10	dip switch for the termination resistor

11	digital outputs K10... K13 (not used)
12	K9 digital output
13	digital outputs K6... K8
14	digital outputs K3... K5
15	high voltage digital inputs

For more information see subsequent sections.

5 FIRST-TIME USE

5.1 First-time use

Proceed as follows.

1. Install the device as shown in section 2 MEASUREMENTS AND INSTALLATION taking all the precautions mentioned in paragraph 0 Installation precautions.
2. Make the electrical connection as shown in section 3 ELECTRICAL CONNECTION taking all the precautions mentioned in paragraph **Errore. L'origine riferimento non è stata trovata.**3 Precautions for electrical connection, without connecting the power supply and the mains.
3. Connect the power supply to the device: the device will show a splash screen for some seconds.
4. Set the time, date and day of the week. See paragraph 14.1 Setting the time, date and day of the week.
5. Configure the device as shown in paragraph 14.2 Setting configuration parameters.

The following table describes the main configuration parameters. The parameters are listed in the recommended configuration order.

PARAM.	DESCRIPTION	FACTORY SETTING
P0	Type of probe 0 = J thermocouple (only for J/K versions) 1 = K thermocouple (only for J/K versions) 2 = Pt 100 (only for Pt 100 versions)	0
P1	Unit of measurement 0 = °C 1 = °F	0
F0	Fan management type 0 = in "on/off" at single speed mode 1 = in "on/off" at single speed mode 2 = in "on/off" at two-speed mode 3 = in modulating mode	0
t0	Steam generation mode 0 = direct 1 = with an external humidifier 2 = combined (both directly and with an external humidifier)	0
u0	Venting output contact type 0 = normally open (venting open with contact closed) 1 = normally closed (venting open with contact open)	0
u1	Load managed by venting output 0 = ON-OFF SOLENOID VALVE 1 = <u>MOTORISED SOLENOID VALVE</u> - with this setting parameters u2, u3 and u4 are relevant	0

Then check that the remaining settings are appropriate; see paragraph 14.3 List of configuration parameters.

6. Connect to the mains supply.
7. Switch on the device; see paragraph 7.1 "Switching the device on and off".

For more information see the subsequent sections.

6 MANAGING THE LOADS

6.1 Initial information

This paragraph describes the loads during normal usage.

To learn the main consequences of an alarm signal, see section **Error. L'origine riferimento non è stata trovata.** ALARMS.

6.2 Temperature adjustment

The output is on until the chamber temperature reaches the working set-point and it switches on again whenever the temperature falls below parameter r0 setting ("working set-point - r0").

To set the working set-point see paragraph 8.2 Cooking cycle settings; to set the configuration parameters see paragraph 14.2 Setting configuration parameters.

6.3 Steam injection

The steam generation method depends on parameter t0, as follows:

- if parameter t0 is set at 0, the steam will be generated directly
- if parameter t0 is set at 1, the steam will be generated by an external humidifier
- if parameter t0 is set at 2, the steam will be generated in combined mode (both directly and with an external humidifier); in this case the temperature set by parameter t12 determines the temperature above which steam will be injected directly and below which steam generated by an external humidifier will be injected (according to the temperature detected by the chamber probe).

Parameter t1 sets the cycle time for the injection of directly generated steam and parameter t2 the duration of steam injection to obtain maximum humidification. If parameter t1 is set at 1000, the steam will be injected on a single-shot basis and not on a cycle basis.

Parameter t6 sets the cycle time for the injection of steam generated by an external humidifier and parameter t7 the duration of steam injection to obtain maximum humidification. If parameter t1 is set at 1000, the steam will be injected on a single-shot basis and not on a cycle basis.

The steam injection deactivates the fan and heater all along the injection (parameter F2=0) for a post-injection pause time set by parameter F9.

It is possible to keep ventilation activated for a few seconds at the beginning of the injection cycle through parameter F2.

To set the humidification, see paragraph 8.2 Cooking cycle settings; to set the configuration parameters, see paragraph 14.2 Setting configuration parameters.

6.4 Venting

The load managed by the venting output depends on the parameter u1 settings, as follows:

- if parameter u1 is set at 0, the load will be an on/off solenoid valve

- if parameter u1 is set at 1, the load will be a motorised solenoid valve.

The vent opens automatically and the end of each phase of the cooking cycle.

To set the duration of the automatic opening of the vent, see paragraph 8.2 Cooking cycle settings.

The vent can also be opened or closed by touching the manual area.



6.5 Chamber light

The chamber light is switched on and off by touching the area labelled .

The light is automatically switched on when the oven is active and when the door is opened.

The light is switched off at the cycle end to show to the user that the cycle is concluded. By pressing the STOP key, the light is automatically switched on.

6.6 Technical room fan

The technical room fan is switched on until the operating temperature of the control module reaches the temperature set by parameter F6 and it is switched on again when the temperature rises above the parameter F7 setting ("F6 + F7"). To set the configuration parameters see the section 14.2 "Setting configuration parameters".

6.7 Fan

The fan management type depends on parameter F0, as follows:

- if parameter F0 is set at 0 or 1, the fan will operate in "on/off" at single speed mode
- if parameter F0 is set at 2, the fan will operate in "on/off" at two-speed mode
- if parameter F0 is set at 3, the fan will operate in modulating mode

If parameter F0 is set at 0, 1 or 2, parameter F1 will set the time the fan is switched off for the purpose of direction inversion and F2 will set the time the fan is switched on for each direction.

If parameter F0 is set at 3, parameters F4 and F5 will set the minimum and maximum fan speeds, parameter F8 will control the minimum fan speed that can be set for the cooking cycles. To set the fan speed see paragraph 8.2 Cooking cycle settings; to set the configuration parameters see paragraph 14.2 Setting configuration parameters.

6.8 Fume reduction

The fume reduction function is activated until the temperature detected by the fume probe reaches the temperature set by parameter t13 and is switched on again whenever the temperature rises above that set by parameter t14 ("t13 + t14"; only if the fume probe is enabled, meaning that parameter P3 is set at 1).

To set the configuration parameters see the section 14.2 Setting configuration parameters.

6.9 ROTOR management

The rotor is operated by:

- the rack rotation motor operating relay;
- the digital input for the rack limit switch which sets the STOP position.

Management of the motor rotation operating relay output and the rack limit switch digital input

The motor rotation output is activated automatically at the start of the cooking cycle.

At the end of the cooking cycle, the rotor will operate according to the value assigned to parameter k6: if k6 = 0, the rotor will keep on rotating; if k6 = 1, the rotor will not rotate until it is manually activated or until a new cooking cycle starts.

It is possible to stop or restart rotation at any time using the motor rotate/stop key on the user interface. The motor will stop once the limit switch input is activated, indicating the status of the rack in place in order for it to be removed safely when the door is opened.

If the limit switch input is out of order, incorrectly cabled or not installed (for example for rotor ovens with a non-removable rack), the rack will stop after the maximum time set by parameter k2.

If the door is opened with rack rotating, the output follows the setting of parameter K4:

- K4 = 0 the motor will stop immediately
- K4 = 1 the motor will stop at the next activation of the limit switch input.

When the door is closed, parameter k1 will control whether the rack starts turning again automatically or is halted in the position it was locked in when the door was opened.

Parameter K5 controls whether it is possible to operate the motor manually with the door open, as follows:

- K5 = 0 With the door open the motor cannot be operated
- K5 = 1 With the door open it will be possible to turn the motor manually by pressing down on the rotor key.

6.10 Suction hood

The suction hood output is activated automatically when the door opens and will be kept on for the time set by parameter k0.

7 USER INTERFACE

7.1 Switching the device on and off

To switch the device on, proceed as follows.

1. Touch .

To switch the device off, proceed as follows.

2. Ensure that no procedure is in progress.
3. Touch .

If the power supply is interrupted when the device is switched on or off, when power is restored the device will return to the status before the interruption.

If the power supply is interrupted during a cooking cycle and the interruption lasts for a shorter time than that set by parameter r12, when power is restored the cycle will be resumed from the start of the phase in which the power failed (if the interruption lasts longer than the time set by parameter r12, the cycle will be interrupted when power is restored).

7.2 Silencing the buzzer

To silence the buzzer, proceed as follows.

1. Ensure that no procedure is in progress.
2. Touch a sensitive area on the display.

8 COOKING CYCLE

8.1 Initial information

Each cooking cycle is preceded by a pre-heating stage. The working set-point relates to the working set-point during the first phase of the cooking cycle, "working set-point during the first cooking cycle phase + working set-point during pre-heating".

During pre-heating the fan works at maximum speed.

When the temperature detected by the chamber probe reaches the working set-point, the buzzer sounds for 3 seconds.

Opening and closing the door sets off the first cooking cycle phase.

Each cooking cycle consists of a minimum of one up to a maximum of six phases. At the end of each phase the device automatically moves on to the next one.

The device is capable of managing the following settings in each phase:

- working set-point
- humidification
- duration of the phase
- fan speed (only if fan management is set to "on/off" two-speed mode or modulating mode, i.e. if parameter F0 is set to 2 or 3)
- The duration of the automatic opening of the vent, meant as the anticipation on the end of the phase.

8.2 Setting the cooking cycle

To set the type of cooking, proceed as follows.

1. Ensure that the device is switched on and that no procedure is in progress.
2. Touch the "manual" key:

select 

13. Repeat actions 5 and 6.

To set/scroll the cooking cycle phases, proceed as follows.

14. Touch the relevant bar 

To add a cooking cycle phase, proceed as follows.

15. Touch the "PH+" key





To cancel the last cooking phase, proceed as follows.

16. Select the phase.
17. Touch the "PH-" key

Cycle start-up:

18. Once all the settings have been done press the "Play" key 

To set the working set-point, proceed as follows.

3. Touch the key 
4. Touch the slide bar 
See also parameters r1 and r2.
5. Touch the green icon  to confirm
Touch the red icon  to exit.



To set the humidification, proceed as follows.

6. Touch the key 
7. Repeat actions 5 and 6.

To set the phase duration, proceed as follows.

8. Touch the key 
9. Repeat actions 5 and 6.

To set the fan speed, proceed as follows.

10. Touch the  key and select the desired speed 
11. Repeat actions 5 and 6.

To set the duration of the vent automatic opening, proceed as follows.

12. Touch the key  and

9 "MY RECIPES" FUNCTION

9.1 Initial information

The "My Recipes" function makes it possible to save the settings of a cooking cycle for a recipe. When the recipe is started up the device uses the settings stored.

It is possible to save up to 99 recipes.





9.2 Saving a recipe

With the device switched on showing "Cycle Details" a recipe can be saved, as follows:

1. Set the cooking cycle; see paragraph 8.2 Setting the cooking cycle.

2. Touch "SAVE"  .

The "My Recipes" screen will appear on which it is possible to select the recipe to be saved.





3. Touch  or  to scroll up and down the pages with the list of recipes.
4. Touch the recipe name in order to save it.
5. Touch the display to give a new name to the recipe.
6. Touch  to exit without overwriting
7. Touch  to confirm.

To change the name of a recipe, proceed as follows.

4. Touch over the name of the recipe to be changed
5. Touch  to confirm.

9.3 Starting up a recipe

To start up a recipe, proceed as follows.

1. Ensure that the device is switched on and that no procedure is in progress.
2. Touch the "recipes" key: 
3. Touch  or  to select the recipe.
4. Touch the display near the recipe to be run.
5. Touch  to start up the recipe.
6. Touch  to enter the recipe settings and make any changes to it.

9.4 Deleting a recipe

To delete a recipe, proceed as follows.

1. From point 4. of paragraph 9.3 "Starting up a Recipe", touch "delete" to delete the recipe in question.

10 "WEEKLY PROGRAMMED SWITCH-ON" FUNCTION

10.1 Initial information

The "Weekly Programmed Switch-on" function makes it possible to programme the device to start up a maximum of 9 times a week and to start up a recipe. See section 9 "MY RECIPES" FUNCTION

10.2 Setting the "Weekly programmed switch-on" function



The procedure operates as follows.

1. Ensure that at least one recipe has been saved, that the device is switched on and no other procedure is in progress.
2. Touch the key  .







To set the switch-on day, proceed as follows.

3. Touch  .

The "Planning" screen will appear on which to make the settings.

4. Touch  or  (within 15 seconds) to go back or forward.
5. Touch the key  to confirm the day entered.

To set the switch-on time, proceed as follows.

6. Touch  .
7. To set the hour, touch  or  (within 15 seconds) to go forward or backward in time.
8. To set the minutes, touch the display near the centre, touch  or  (within 15 seconds) to go forward or backward in time.
9. Touch the key  to confirm the setting.

To set the recipe to be used, proceed as follows starting from the main screen:

10. Touch the "recipes" key .
11. Repeat actions 3.-5. in paragraph 9.3 "Starting up a recipe".

10.3 Activating the "Weekly programmed switch-on" function

The procedure operates as follows.

1. Ensure that at least one switch-on event has been set, that the device is switched on and no other procedure is in progress.
2. Touch  for 1 second.

To select a switch-on event, proceed as follows.

3. Touch  or .

To change a switch-on event, proceed as follows.

4. Repeat actions 3.-11. in paragraph 10.2 "Setting the "Weekly programmed switch-on" function".

To activate the function, proceed as follows.

5. Touch .

To deactivate the function, proceed as follows.

6. Touch  before action 4.

11 OTHER FUNCTIONS

11.1 View alarm status

The procedure operates as follows.

1. Ensure that the device is switched on and that no procedure is in progress.
2. Touch .
3. Touch "ALARM LIST".

11.2 View process and machine status variables

The procedure operates as follows.

1. Ensure that the device is switched on and that no procedure is in progress.
2. Touch .
3. Touch "INTERNAL VALUES".

11.3 Setting the screen language

The procedure operates as follows.

1. Ensure that the device is switched on and that no procedure is in progress.
2. Touch .
3. Touch "LANGUAGE" to select the language.
4. Touch the display on the language to be selected.

12 BOILER EXPANSION

12.1 Activating expansion

The following conditions must be met to enable to EVCLE305XXE boiler expansion.

1. Enable the boiler by setting parameter T15 (T15 = 1)
2. Set the steam generation mode with external or mixed humidification by setting parameter T0 (T0 = 1 or 2)
3. Board on.

12.2 Electrical connection

Example for Vcolor 348L.

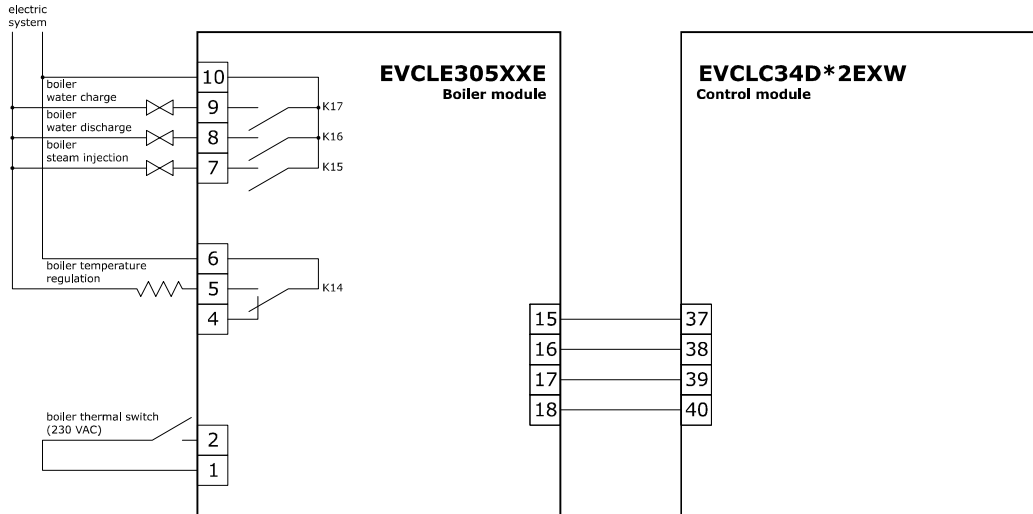



12.3 Operation

12.3.1 Water load management

With the board ON the water is loaded and kept above the maximum level.

If the necessary minimum level is not reached within the prescribed time (parameter t27), the "MIN. BOILER WATER LEVEL" alarm signal will be activated.

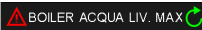
If the necessary maximum level is not reached within the prescribed time (parameter t28), the "MAX. BOILER WATER LEVEL" alarm signal will be activated.

These alarms can be reset manually using key , pressing  to reset the alarm and start up a new water loading cycle.

12.3.2 Water heating management

With the board ON the water is heated and kept at "Boiler steam maintenance temperature" (parameter t18). During cooking, boiler or chamber cleaning the water is heated and kept at "Boiler steam working temperature" (parameter T17).

If there is a lack of water (minimum level not reached) this operation is deactivated.

13 BURNER EXPANSION

13.1 Activating expansion

To enable burner expansion parameter b14 = 1 (gas oven) must be set.

13.2 Electrical connection

Example for Vcolor 348L.

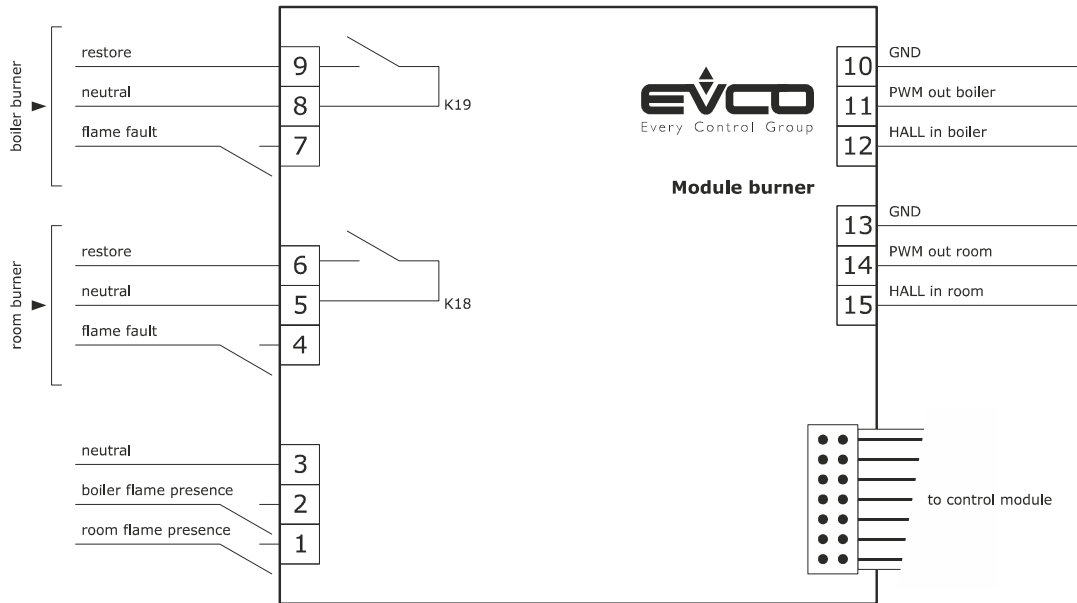

13.3 Application diagram

The EVCLE302XXE burner module interacts with electronic ignition circuit boards for Honeywell series 4565 and similar atmospheric burners and with variable speed centrifugal fans with PWM control + feedback.
 Example for Vcolor 348L.

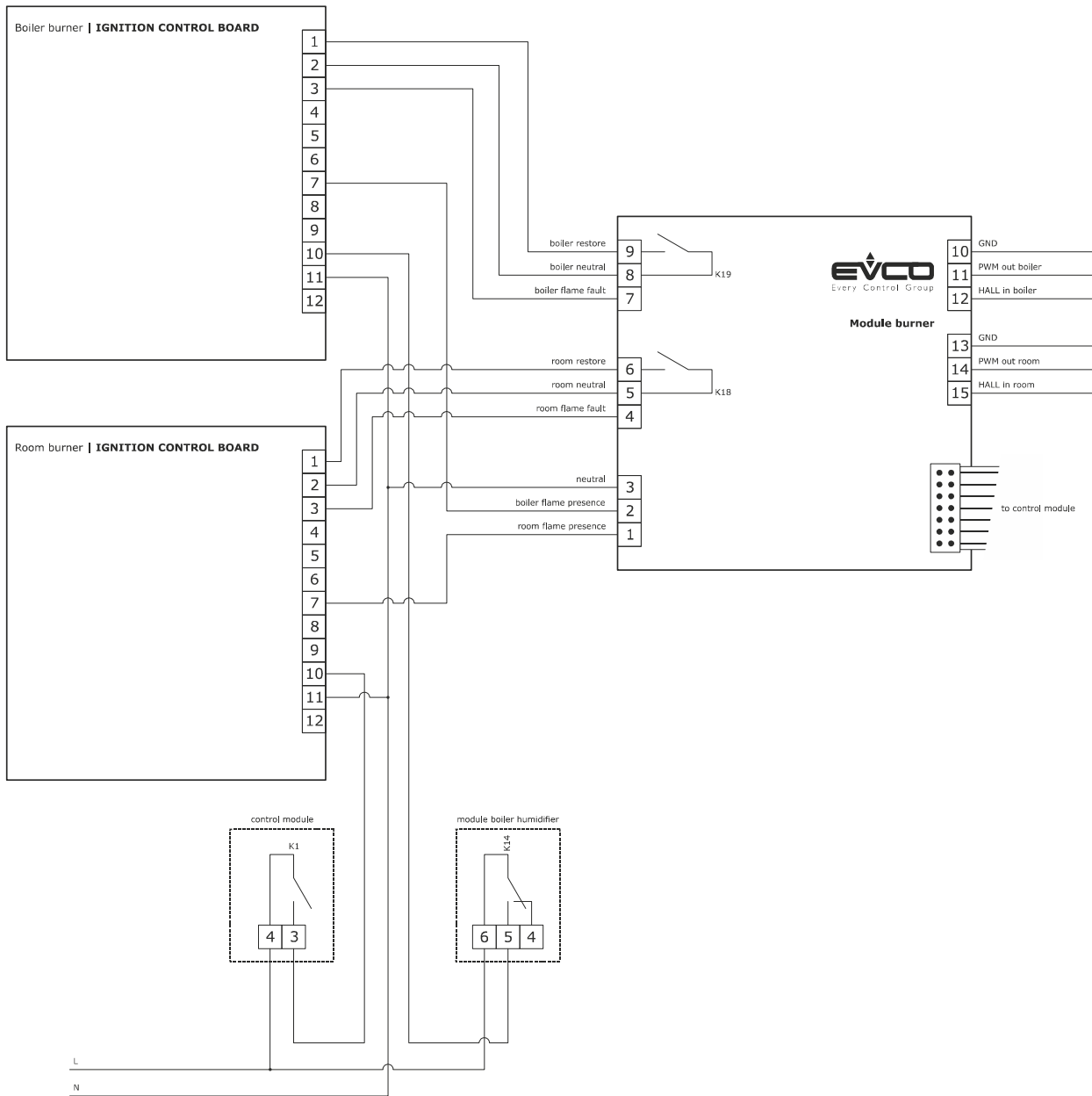

13.4 Operation

During the heating phase, the controller activates the chamber and boiler heating outputs also activating the relevant burner with a power in proportion to the distance from the temperature controlled by the working set-point by adjusting the rotation speed of the centrifugal fan. In addition to activating the chamber or boiler heater, during heating the corresponding burner is activated and the power used to heat the oven is adjusted in proportion to the burner speed.

The burner is activated as follows:

1. Pre-ventilation phase: the burner speed is raised to the value set by parameter b2 for the chamber burner or parameter b9 for the boiler burner, keeping this constant for 10 seconds.
2. Ignition phase: after the pre-ventilation time has elapsed, the feedback from the Hall sensor checks the stability of the speed and then the burner control unit is activated by activating the corresponding relay (chamber or boiler heating). After the presence of the digital input flame has been checked the heating phase begins.
3. Heating phase: the burner reaches the speed required by the controller for heating the oven. This value is calculated in proportion to the temperature band set by parameter b3 for the chamber or b10 for the boiler. The speed may vary from the minimum set by parameter b1 for the chamber or b8 for the boiler to a maximum set by parameter b0 for the chamber or b7 for the boiler.

13.5 Error management

Ignition phase:

if no flame is present during the ignition phase, the burner stays at ignition speed.

Heating phase:

if no flame is present during the heating phase, the activation relay is switched off, the fan returns to the ignition speed for 10 seconds and after 20 seconds another attempt is made to switch this on.

Chamber/boiler burner fault alarm:

when the control unit activates the digital input for the chamber/boiler burner fault, a reset procedure takes place in which 3 attempts are made to switch on the burner in fault state before raising the alarm.

Chamber burner alarm:

the burner speed is always checked by the Hall input and if the speed set for the chamber burner differs from the actual speed by a value above parameter b5 for a period longer than parameter b6, the alarm is raised.

Boiler burner alarm:

the burner speed is always checked by the Hall input and if the speed set for the boiler burner differs from the actual speed by a value above parameter b12 for a period longer than parameter b13, the alarm is raised.

14 CONFIGURATION

14.1 Setting the time, date and day of the week



The procedure operates as follows.

1. Ensure that the device is switched on and that no procedure is in progress.
2. Touch .

To select a value, proceed as follows.





3. Touch  repeatedly until the green rectangle shows the desired value.

To set a value, proceed as follows.



5. Touch  or  to change the value.
6. Touch  after changing the values to confirm.

14.2 Setting configuration parameters



The procedure operates as follows.

1. Ensure that the device is switched on and that no procedure is in progress.
2. Touch .
3. Touch "SERVICE".
4. Touch  or  to set password "**-19**".
5. Touch  to confirm.

To select a parameter, proceed as follows.

6. Touch  or  to select the desired parameter.

To set a parameter, proceed as follows.

7. Touch the desired parameter.
8. Touch  or  to set the value.
9. Touch  to confirm.

14.3 List of configuration parameters

The table below describes the configuration parameters of the device.

PARAM.	MIN.	MAX.	U.M.	DEF.	ANALOGUE INPUTS
P0	0	2	---	0	Type of probe 0 = J thermocouple (only for J/K versions) 1 = K thermocouple (only for J/K versions) 2 = Pt 100 (only for Pt 100 versions)
P1	0	1	---	0	Temperature measurement unit (1) 0 = °C 1 = °F
P2	0	1	---	0	Unused
P3	0	2	---	0	Enable fume/condenser water discharge probe 0 = probe not enabled 1 = fume probe 2 = water discharge probe
CA1	-25/-50	25/50	°C/°F (2)	0	Chamber probe offset
CA2	-25/-50	25/50	°C/°F (2)	0	Unused
CA3	-25/-50	25/50	°C/°F (2)	0	fume probe offset
PARAM.	MIN.	MAX.	U.M.	DEF.	MAIN REGULATOR
r0	1	99	°C/°F (2)	5	If r13 = 0 working set-point differential (referring to the temperature detected by the chamber probe) If r13 = 1 proportional band for adjusting PI
r1	0	r2	°C/°F (2)	0	Minimum working set-point (referring to the temperature detected by the chamber probe)
r2	r1	500	°C/°F (2)	300	Maximum working set-point (referring to the temperature detected by the chamber probe)
r3	r1	r2	°C/°F (2)	130	Working set-point for factory setting (referring to the temperature detected by the chamber probe). See also r0
r4	0	r5	°C/°F (2)	0	Unused
r5	r4	500	°C/°F (2)	100	Unused
r6	r4	r5	°C/°F (2)	30	Unused
r7	0	r8	°C/°F (2)	0	Unused
r8	r7	150	°C/°F (2)	30	Unused
r9	r7	r8	°C/°F (2)	5	Unused
r10	-199	199	°C/°F (2)	10	Working set-point during pre-heating (referring to the working set-point during the first cooking cycle phase, i.e. "working set-point during the first cooking cycle phase + r10"; referring to the temperature detected by the chamber probe). See also parameter r0
r11	0	500	°C/°F (2)	50	Unused
r12	0	240	min	240	Duration of a power failure during the cooking cycle sufficient to interrupt it (3)
r13	0	1	---	0	Type of temperature adjustment 0 = ON-OFF 1 = PI (Proportional-Integral), FOR ELECTRIC OVENS ONLY

r14	60	999	s	180	Minimum time between two consecutive output switch-ons for temperature adjustment (only valid if r13 = 1)
r15	10	240	s	10	Minimum on/off duration of the output for temperature adjustment (only valid if r13 = 1)
r16	0	240	min	30	Integral time (only valid if r13 = 1)
PARAM.	MIN.	MAX.	U.M.	DEF.	MISCELLANEOUS
c0	-1	120	s	10	Duration of buzzer activation on completion of the cooking cycle -1 = until manually silenced
c1	0	1	- - -	0	Buzzer activation (for 1 second) at the end of a cooking cycle phase
c2	0	240	min	60	Time that has to pass if the device is not operated (from activation of the "weekly programmed switch-on" function) in order for it to switch off
c3	0	99	°C/°F (2)	10	Temperature above which the temperature detected by the chamber probe cannot be displayed (referring to the working set-point, i.e. "working set-point + c3") 0 = function absent
c4	0	99	°C/°F (2)	10	Temperature under which the temperature detected by the chamber probe cannot be displayed (referring to the working set-point, i.e. "working set-point - c4") 0 = function absent
PARAM.	MIN.	MAX.	U.M.	DEF.	FAN
F0	0	3	- - -	0	Fan management type 0 = in "on/off" mode at single speed 1 = in "on/off" mode at single speed 2 = in "on/off" mode at two-speed 3 = in modulating mode
F1	5	120	s	15	Unused
F2	0	10	s	0	Time the fan (and the heater) is kept switched-on at the beginning of the steam injection cycle 0 = switched-off all along the injection cycle
F3	0	1	- - -	0	Unused
F4	0	F5	%	0	Minimum fan speed (meaning the percentage of the maximum speed; only if F0 = 3)
F5	F4	100	%	100	Maximum fan speed (meaning the percentage of the maximum speed; only if F0 = 3)
F6	20/65	65/150	°C/°F (2)	60	Temperature above which the technical room fan is switched on (referring to the operating temperature of the control module). See also F7
F7	1	99	°C/°F (2)	10	F6 differential
F8	0	100	%	10	Minimum fan speed that can be set by the user (meaning the percentage of the maximum speed; only if F0 = 3)
F9	0	120	s	10	Time the fan is switched off after humidification 0 = no switch-offs
F10	0	999	°C/°F (2)	150	Temperature below which the fan is switched off after the controller is switched off

PARAM.	MIN.	MAX.	U.M.	DEF.	STEAM INJECTION
t0	0	2	---	0	Steam generation mode 0 = direct 1 = with an external humidifier 2 = combined (both directly and with an external humidifier)
t1	t2	1000	s	60	Cycle time for injection of steam generated directly 1000 = single cycle of steam injection
t2	0	t1	s	30	Maximum value the end user can set for the injection of steam generated directly
t3	0	999	s	60	Delay of injection of steam generated directly from the start-up of a cooking cycle phase 0 = the controller manages chamber humidification at the humidity value set for the first cooking cycle phase, also during pre-heating
t4	0	1	---	0	Unused
t5	0	1	---	0	Unused
t6	t7	1000	s	60	Cycle time for injection of steam generated by an external humidifier 1000 = single steam injection
t7	0	t6	s	30	Maximum value the end user can set for the injection of steam generated by an external humidifier
t8	0	999	s	60	Delay of injection of steam generated by an external humidifier from the start-up of a cooking cycle phase 0 = the controller manages chamber humidification at the humidity value set for the first cooking cycle phase, also during pre-heating
t9	0	1	---	0	Unused
t10	0	1	---	0	Unused
t11	0	240	s	5	Unused
t12	0	500	°C/°F (2)	120	Temperature above which directly generated steam injection is activated and below which steam generated by an external humidifier is injected (referring to the temperature detected by the chamber probe; only if t0 = 2)
t13	0	500	°C/°F (2)	90	Temperature above which fume reduction is activated (referring to the temperature detected by the fume probe). See also t14
t14	1	99	°C/°F (2)	5	t13 differential
t15	0	1	---	0	Enable boiler expansion 1 = YES
t16	1	500	°C/°F (2)	80	Boiler temperature above which boiler steam injection is enabled
t17	1	500	°C/°F (2)	95	Boiler steam working temperature
t18	1	500	°C/°F (2)	70	Boiler steam maintenance temperature
t19	1	99	°C/°F (2)	2	Hysteresis for t17, t18
t20	0	240	s	2	Delay in boiler water loading stop
t21	0	240	min	2	Delay in boiler water discharge stop
t22	0	240	min	25	Unused

t23	1	500	°C/°F (2)	60	Unused
t24	0	240	min	20	Unused
t25	1	500	°C/°F (2)	60	Unused
t26	1	10	---	3	Unused
t27	0	240	s	5	Alarm activation delay for water at minimum level
t28	0	240	min	3	Alarm activation delay for water at maximum level
t29	0	1	---	1	Humidification value display 0 = percentage (gastronomy ovens) 1 = in seconds (bread/pastry ovens)
PARAM.	MIN.	MAX.	U.M.	DEF.	TEMPERATURE ALARMS
A0	1	99	°C/°F (2)	10	A1 differential
A1	0	500	°C/°F (2)	0	Temperature above which the maximum temperature alarm is raised (referring to the temperature detected by the chamber probe). See also A0 and A3
A2	0	240	min	0	Maximum temperature alarm delay
A3	0	2	---	0	Type of maximum temperature alarm 0 = alarm absent 1 = absolute (A1) 2 = relative to the working set-point ("working set-point + A1")
A4	0	80/175	°C/°F (2)	70	Temperature above which the working temperature alarm is raised (referring to the working temperature of the control module) 0 = alarm absent
PARAM.	MIN.	MAX.	U.M.	DEF.	DIGITAL INPUTS
i0	0	1	---	0	Door switch input contact type 0 = normally open (input active with contact closed) 1 = normally closed (input active with contact open)
i1	0	1	---	0	Fan thermal switch input type 0 = normally open (input active with contact closed) 1 = normally closed (input active with contact open)
i2	0	1	---	0	unused
i3	0	1	---	0	Safety thermal switch input type 0 = normally open (input active with contact closed) 1 = normally closed (input active with contact open)
i4	0	1	---	0	Power input contact type 0 = normally open (input active with contact closed) 1 = normally closed (input active with contact open)
PARAM.	MIN.	MAX.	U.M.	DEF.	DIGITAL OUTPUTS
u0	0	1	---	0	Venting output contact type 0 = normally open (venting open with contact closed) 1 = normally closed (venting open with contact open)
u1	0	1	---	0	Load managed by venting output 0 = ON/OFF SOLENOID VALVE 1 = MOTORIZED SOLENOID VALVE - with this setting parameters u2, u3 and u4 are relevant

u2	0	600	ds (s/10)	120	Duration of the venting output stoppage from the end of the short pulse for opening the vent and from the end of the long pulse for closing it (only if u1 = 1). See also u3 and u4
u3	0	600	ds (s/10)	10	Duration of the short pulse for opening the vent (only if u1 = 1). See also u2 and u4
u4	0	600	ds (s/10)	30	Duration of the long pulse for closing the vent (only if u1 = 1). See also u2 and u3
PARAM.	MIN.	MAX.	U.M.	DEF.	SERIAL NETWORK
LA	1	247	- - -	247	Device address
Lb	0	3	- - -	2	Baud rate 0 = 2,400 baud 1 = 4,800 baud 2 = 9,600 baud 3 = 19,200 baud
LP	0	2	- - -	2	Parity 0 = none 1 = odd 2 = even
PARAM.	MIN.	MAX.	U.M.	DEF.	ROTOR
k0	0	100	s	10	Duration of suction hood activation after the door opens
k1	0	1	- - -	1	Motor action after the door closes 0 = the motor remains stopped 1 = the motor returns to its state before the door was opened
k2	0	100	s	10	Maximum duration of rotor activation fromr switch-off request when the rack limit switch digital input is not activated
k3	0	1	- - -	0	Rack limit switch input contact type 0 = normally open (input active with contact closed) 1 = normally closed (input active with contact open)
K4	0	1	- - -	0	Effect on the rotor by door opening 0 = the rotor stops immediately 1 = the rotor stops at the next activation of the limit switch input
K5	0	1	- - -	0	Manual rotor activation when the door is opened 0 = with the door open it will not be possible to act on the rotor 1 = with the door open it will be possible to operate the rotor manually by pressing down on the rotor key.
K6	0	1	- - -	0	Rotor operation at the end of cooking cycle 0 = the rotor keeps rotating 1 = the rotor stops until it is automatically activated at the start of a new cooking cycle
PARAM.	MIN.	MAX.	U.M.	DEF.	UNUSED
w0	0	500	°C/°F (2)	60	Unused
w1	1	99	°C/°F (2)	10	Unused
w2	0	240	min	10	Unused
w3	0	500	°C/°F (2)	70	Unused
w4	0	240	s	5	Unused
w5	0	240	min	10	Unused

w6	0	240	min	10	Unused
w7	0	240	s	10	Unused
w8	0	500	°C/°F (2)	70	Unused
w9	0	240	s	5	Unused
w10	0	240	min	10	Unused
w11	0	240	min	10	Unused
w12	0	500	°C/°F (2)	60	Unused
w13	0	240	min	5	Unused
w14	0	500	°C/°F (2)	100	Unused
w15	0	240	min	10	Unused
w16	0	240	sec	15	Unused
w17	0	1	s	1	Unused
w18	r0	99	°C/°F (2)	7	Unused
w19	0	500	°C/°F (2)	70	Unused
W20	0	1	---	1	Unused
PARAM.	MIN.	MAX.	U.M.	DEF.	BURNERS
b0	2500	6000	RPM	5000	Chamber burner maximum revolution number
b1	1500	4000	RPM	2500	Chamber burner minimum revolution number
b2	1000	3000	RPM	1000	Chamber burner ignition revolution number
b3	1	99	°C/°F (2)	10	Band for chamber temperature proportional adjustment
b4	2	10	sec	3	Chamber ramp time
b5	200	1000	RPM	200	Chamber burner alarm revolution number
b6	10	120	sec	10	Chamber burner revolution alarm delay
b7	2500	6000	RPM	5000	Boiler burner maximum revolution number
b8	1500	4000	RPM	2500	Boiler burner minimum revolution number
b9	1000	3000	RPM	1000	Boiler burner ignition revolution number
b10	1	99	°C/°F (2)	10	Band for boiler temperature proportional adjustment
b11	2	10	sec	3	Boiler ramp time
b12	200	1000	RPM	200	Boiler burner alarm revolution number
b13	10	120	sec	10	Boiler burner revolution alarm delay
b14	0	1	---	0	Type of oven 0 = electric, 1 = gas
PARAM.	MIN.	MAX.	U.M.	DEF.	
e0	0	1	---	1	Unused
e1	0	1	---	1	Keypad lock 0 = disabled 1 = automatic

Notes

- (1) Set the appropriate parameters for the regulators after setting parameter P1

- (2) The unit of measurement depends on parameter P1
- (3) If the power failure duration is lower than the time set by parameter r12, when power is restored the cycle will be restarted from the beginning of cycle in which the power failed.

15 USING THE USB PORT

15.1 Initial information

The USB port makes possible the following operations.

- Upload and download of the settings in the recipes of the "My Recipes" function and in the working cycles of the "Special Cycles" function (known as "programs" from here on)
- Upload and download of the settings in the configuration parameters.

These operations are guaranteed by using the EVUSB4096M USB device.

Uploading operations are only possible if the firmware of the device from which it originates and the firmware of the destination device are the same.

15.2 Uploading the program settings

The program settings can be uploaded as follows.

1. Ensure that the device is switched off and that no procedure is in progress.
2. Insert a USB flash drive containing a text document named "prog.txt" in the USB port of the device and wait for a few seconds.
3. Touch "UPLOAD PROGRAMS".
4. Touch  to confirm.
5. When the upload has finished remove the USB flash drive from the port of the device.

15.3 Downloading the program settings

The program settings can be downloaded as follows.

1. Ensure that the device is switched off and that no procedure is in progress.
2. Insert a USB flash drive in the USB port of the device and wait for a few seconds.
3. Touch "DOWNLOAD PROGRAMS".
4. Touch  to confirm.

15.4 Uploading the settings in the configuration parameters

The program settings can be uploaded as follows.

1. Ensure that the device is switched off and that no procedure is in progress.
2. Insert a USB flash drive containing a text document named "prog.txt" in the USB port of the device and wait for a few seconds.
3. Touch "UPLOAD PARAMETERS".
4. Touch  to confirm.
5. When the upload has finished remove the USB flash drive from the port of the device.

15.5 Downloading the settings in the configuration parameters

The program settings can be downloaded as follows.

1. Ensure that the device is switched off and that no procedure is in progress.
2. Insert a USB flash drive in the USB port of the device and wait for a few seconds.
3. Touch "DOWNLOAD PARAMETERS".
4. Touch  to confirm.

16 ALARMS

16.1 Alarms

If an alarm happens the buzzer sounds and the display shows the  icon and an alarm code. Touch the display near the centre to silence the buzzer and restore the normal view.

The table below shows the meaning of the device's various alarm codes.

ALARM CODE	DESCRIPTION
Chamber probe ALARM	<p>Chamber probe alarm</p> <p>To correct</p> <ul style="list-style-type: none"> - Check the type of probe; see parameter P0 - Check the device-probe connection - Check the chamber temperature <p>Main results</p> <ul style="list-style-type: none"> - If the alarm is raised when the device is on it will not be possible to start up a cooking cycle - If the alarm is raised during a cooking cycle, the cycle will be interrupted - The temperature adjustment output will be switched off
Fume probe ALARM	<p>Fume probe alarm</p> <p>To correct</p> <ul style="list-style-type: none"> - As in the previous case, but working on the fume probe <p>Main results</p> <ul style="list-style-type: none"> - The fume reduction management output will be switched off
Power failure ALARM	<p>Power failure alarm</p> <p>To correct</p> <ul style="list-style-type: none"> - Check the device-power supply connection. <p>Main results</p> <ul style="list-style-type: none"> - If the alarm is raised when the device is switched on or off, the device will switch off once the power is restored - If the alarm is raised during a cooking cycle and the interruption lasts for a shorter time than that set by parameter r12, when power is restored the cycle will be resumed from the start of the phase in which the power failed (if the interruption lasts longer than the time set by parameter r12, the cycle will be interrupted when power is restored).
No connection ALARM	<p>User interface-control module communication alarm</p> <p>To correct</p> <ul style="list-style-type: none"> - Check the user interface-control module connection. <p>Main results</p> <ul style="list-style-type: none"> - If the alarm is raised when the device is on it will not be possible to start up a cooking cycle - If the alarm is raised during a cooking cycle, there will be no effect
Temperature ALARM	<p>Maximum temperature alarm</p> <p>To correct</p> <ul style="list-style-type: none"> - Check the temperature detected by the chamber probe. See parameters A0, A1 and A3 <p>Main results</p> <ul style="list-style-type: none"> - No effect
High board temperature ALARM	<p>Operating temperature alarm</p> <p>To correct</p> <ul style="list-style-type: none"> - Check the operating temperature of the control module; see parameter A4 <p>Main results</p> <ul style="list-style-type: none"> - If the alarm is raised when the device is on it will not be possible to start up a cooking cycle - If the alarm is raised during a cooking cycle, the cycle will be interrupted - The vent will open, the technical room fan will switch on and the remaining outputs will be switched off
	<p>Door switch input alarm</p> <p>To correct</p> <ul style="list-style-type: none"> - Check the cause of the input activation; see parameter i0

	<p>Main results</p> <ul style="list-style-type: none"> - If the alarm is raised during a cooking cycle, the temperature adjustment output, the fan and the steam injection output will be switched off and the vent opened
Thermal switch ALARM	<p>Fan thermal switch input alarm</p> <p>To correct</p> <ul style="list-style-type: none"> - Check the cause of the input activation; see parameters i1 and i2 <p>Main results</p> <ul style="list-style-type: none"> - If the alarm is raised during a cooking cycle, the temperature adjustment output and the fan will be switched off
Peak consumption ALARM	<p>Power input alarm</p> <p>To correct</p> <ul style="list-style-type: none"> - Check the cause of the input activation; see parameter i4 <p>Main results</p> <ul style="list-style-type: none"> - If the alarm is raised during a cooking cycle, the outputs will be switched off
Boiler probe ALARM	<p>Boiler probe alarm</p> <p>To correct</p> <ul style="list-style-type: none"> - Check the type of probe; see parameter P0 - Check the device-probe connection - Check the boiler temperature <p>Main results</p> <ul style="list-style-type: none"> - The boiler temperature adjustment output will be deactivated
Minimum boiler water level ALARM	<p>Below minimum water loading level boiler alarm</p> <p>To correct</p> <ul style="list-style-type: none"> - Check the boiler input; see parameter t27 <p>Main results</p> <ul style="list-style-type: none"> - The boiler temperature adjustment output will be deactivated
Maximum boiler water level ALARM	<p>Over maximum water loading level boiler alarm</p> <p>To correct</p> <ul style="list-style-type: none"> - Check the boiler input; see parameter t28 <p>Main results</p> <ul style="list-style-type: none"> - The boiler temperature adjustment output will be deactivated
Boiler discharge ALARM	<p>Boiler discharge alarm</p> <p>To correct</p> <ul style="list-style-type: none"> - Check the Min, Max H2O Boiler inputs; see parameter t21 <p>Main results</p> <ul style="list-style-type: none"> - The boiler temperature adjustment output will be deactivated
Boiler communication ALARM	<p>Control module–boiler expansion module communication alarm</p> <p>To correct</p> <ul style="list-style-type: none"> - Check the control module–boiler expansion module connection <p>Main results</p> <ul style="list-style-type: none"> - All the boiler adjustments will be deactivated
Boiler safety ALARM	<p>Boiler safety alarm</p> <p>To correct</p> <ul style="list-style-type: none"> - Check the cause of the input activation <p>Main results</p> <ul style="list-style-type: none"> - All the boiler adjustments will be deactivated
Chamber/boiler burner fault ALARM	<p>Burner fault alarm</p> <p>To correct</p> <ul style="list-style-type: none"> - Check the cause of the burner fault <p>Main results</p> <ul style="list-style-type: none"> - The chamber/boiler burner will be deactivated

Chamber/boiler burner ALARM	Chamber/boiler burner alarm
	To correct
	- Check that the centrifugal fan is working properly, the feedback from the Hall sensor and parameters b5/b6 (chamber) or b12/b13 (boiler)
	Main results
	- The chamber/boiler burner will be deactivated

When the cause of the error has been eliminated the device returns to normal working.

17 ACCESSORIES

17.1 Non-optoisolated RS-485/USB serial interface

The interface enables the device to be connected to the Parameters Manager set-up software system.



17.2 USB plug for panel installation

The plug makes the USB communications port of the device more accessible.

To connect the device to the plug, connecting cable 0810500018 or 0810500020 must be used (to be ordered separately).



17.3 0810500018/0810500020 connecting cables

These cables are used to connect the USB plug for panel installation 0812000002 to the device.

Cable 0810500018 is 2 m long; cable 0810500020 is 0.5 m long.



17.4 EVUSB4096M 4GB USB flash drive

The flash drive makes it possible to upload and download the settings and the data recorded by the device.



18 TECHNICAL SPECIFICATIONS

18.1 Technical specifications

Purpose of the control device	Function controller	
Construction of the control device	Built-in electronic device	
Container	user interface	control module
	Black, self-extinguishing	Open frame board
Measurements	user interface	control module
	118.0 x 166.0 x 35.0 mm (4.645 x 6.535 x 1.377 in; L x H x D).	113.5 x 255.0 x 33.0 mm (4.468 x 10.039 x 1.299 in; L x H x D).
Mounting methods for the control device	user interface	control module
	Installed from behind using threaded studs to guarantee flush fitting.	On a flat surface with spacers.
Degree of protection	user interface	control module
	IP40	IP00
Connections	user interface	control module
	plug-in screw terminal blocks (control module and RS-485 MODBUS port), type A USB connector (USB port).	Plug-in screw terminal blocks (user interface, power supply, inputs and outputs).
	The maximum length of the connection cables of analogue inputs, digital inputs and analogue output must be lower than 10 m (32.808 ft). The maximum length of the connection cables of user interface-control module must be lower than 10 m (32.808 ft).	
Operating temperature	From 0 to 55 °C (from 32 to 131 °F)	
Storage temperature	From -10 to 70 °C (from 14 to 158 °F).	
Operating humidity	Relative humidity without condensate from 10 to 90%	
Pollution status of the control device	2.	
Power supply	user interface	control module
	provided by the control module	12 VAC (±15%), 50 / 60 Hz (±3 Hz), 20 VA max.
Rated impulse-withstand voltage	4 KV	
Over-voltage category	III	
Software class and structure	A	
Clock	Built-in	
	Autonomy in the absence of a power supply: 24 hours with full charge.	
	Battery charging time: 2 min (the battery is charged by the power supply of the device).	
Analogue inputs	2 inputs (chamber probe and fume probe) that can be set using the configuration parameter for the J/K thermocouples or the Pt 100 2-wire probes.	
	Thermocouple J type analogue inputs Sensor type: iron/constantan. Measurement field: from -50 to 700 °C (from -58 to 1,292 °F). Resolution: 1 °C (1 °F). Protection: none	
	Thermocouple K type analogue inputs Sensor type: chromel/alumel. Measurement field: from -50 to 1,100 °C (from -58 to 2,012 °F). Resolution: 1 °C (1 °F). Protection: none	

	<p>Pt 100 type analogue inputs</p> <p>Sensor type: Pt 100 class A.</p> <p>Measurement field: from -50 to 550 °C (from -58 to 1,022 °F).</p> <p>Resolution: 1 °C (1 °F).</p> <p>Protection: none</p>
Digital inputs	<p>5 inputs:</p> <ul style="list-style-type: none"> - 2 (door switch and rotor rack limit switch) can be set using the configuration parameter for a normally open/normally closed contact (dry contact, 5 VDC, 0.5 mA) - 3 (fan thermal switch, thermal switch and power consumption) can be set using the configuration parameter for a normally open/normally closed contact (high voltage contact, 230 VAC)
	<p>digital inputs for dry contact</p> <p>Power supply: none</p> <p>Protection: none</p>
	<p>digital inputs for high voltage contact</p> <p>Power supply: 230 VAC.</p> <p>Protection: none.</p>
Analogue outputs	<p>1 0-10 V output for fan management (in this case an external speed regulator should also be used).</p>
Digital outputs	<p>13 outputs (electro-mechanical relays), 9 used for:</p> <ul style="list-style-type: none"> - 1 1 A res. @ 250 VAC type SPST (K1) output for managing the chamber temperature adjustment - 1 1 A res. @ 250 VAC type SPST (K2) output for managing the vent - 1 1 A res. @ 250 VAC type SPDT (K3) output for managing fan speed 1 or 2 - 1 1 A res. @ 250 VAC type SPST (K4) output unused - 1 1 A res. @ 250 VAC type SPST (K5) output for managing fan activation - 1 1 A res. @ 250 VAC type SPST (K6) output for managing rack rotation - 1 1 A res. @ 250 VAC type SPST (K7) output for managing technical room fan - 1 1 A res. @ 250 VAC type SPDT (K8) output for managing direct steam injection - 1 4 A res. @ 250 VAC type SPST (K9) output for managing the chamber light - 1 1 A res. @ 250 VAC type SPDT (K10) output for managing the suction hood - 3 1 A res. @ 250 VAC type SPST (K11, K12, K13) outputs unused <p>* The relays do not manage LED and fluorescent lamps</p>
Displays	<p>5- or 7-inch TFT touch-screen graphic display, 16K colours, 800 x 480 pixel resolution. The presence of point defects on the display falls within the tolerance limits as provided by applicable standards.</p>
Type 1 or Type 2 Actions	<p>Type 1.</p>
Additional features of Type 1 or Type 2 actions	<p>C</p>
Communications ports	<p>2 ports:</p> <ul style="list-style-type: none"> - 1 RS-485 MODBUS port - 1 USB port
Warning and alarm buzzer	<p>Built-in</p>

Vcolor 348

Controller for electric rotary ovens for bread and pastry-making, with a 5 or 7-inch colour TFT touch-screen graphic display, in split version that can be built into the unit.

Installer manual ver. 2.0

GL - 23/18

Code 144VC348E204

This document and the solutions contained therein are the intellectual property of EVCO and thus protected by the Italian Intellectual Property Rights Code (CPI). EVCO imposes an absolute ban on the full or partial reproduction and disclosure of the content other than with the express approval of EVCO. The customer (manufacturer, installer or end-user) assumes all responsibility for the configuration of the device. EVCO accepts no liability for any possible errors in this document and reserves the right to make any changes, at any time without prejudice to the essential functional and safety features of the equipment.



EVCO S.p.A.
Via Feltre 81, 32036 Sedico Belluno ITALY
Tel. 0437/8422 | Fax 0437/83648
info@evco.it | www.evco.it