



PLEASE READ CAREFULLY
and save this document
CONSIDER THE ENVIRONMENT

1 ENGLISH

- power supply 115... 230 VAC or 24 VAC (according to the model)
- built-in clock
- chamber probe or top and floor probes (J/K or Pt 100 2-wire)
- multi-purpose input
- steam generator relay, 16 A res. @ 250 VAC
- alarm buzzer
- TTL MODBUS slave port for programming key or for BMS
- INTRABUS master/slave port (deck centralized management)
- USB port (set up recipe book)
- on-off/PI control
- independent regulation of the power or the top and floor temperature.

Models available

Purchasing code	Power supply	Type of analogue inputs	Number of digital outputs	Type of digital outputs for top and floor
EV8318J9	115... 230 VAC	for J/K thermocouples or Pt 100 2-wire probes	8	electro-mechanical relay
EV8318J4	24 VAC	for Pt 100 2-wire probes and J/K thermocouples	8	electro-mechanical relay

1 MEASUREMENTS AND INSTALLATION

Measurements in mm (inches). To be fitted to a panel, screwed-in brackets provided.

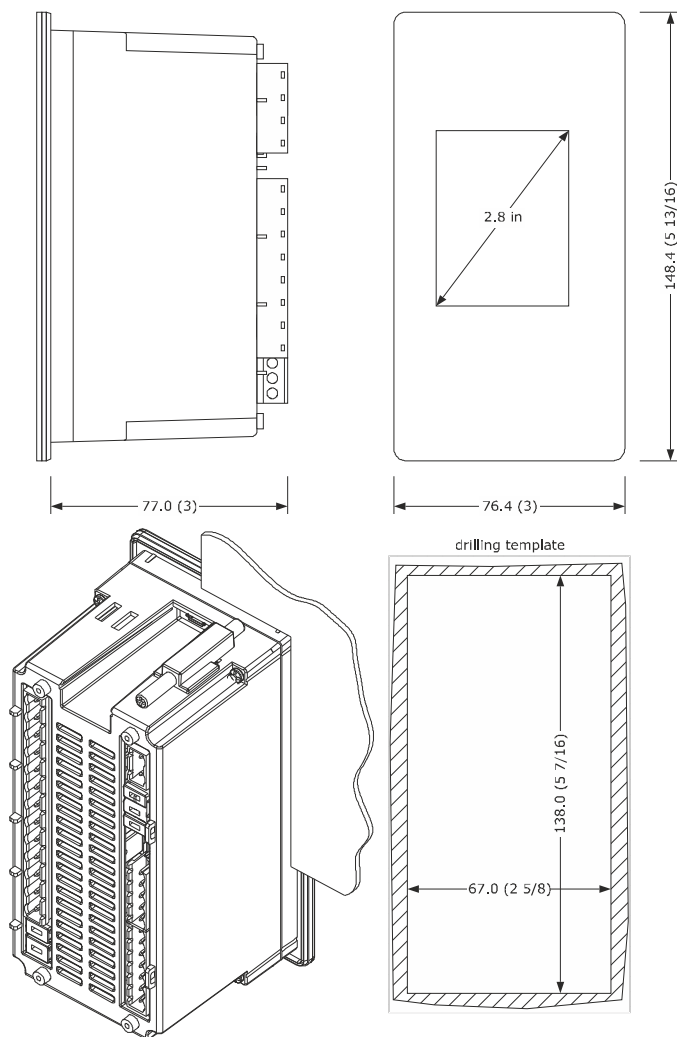

The tolerance of the measurements of the drilling template is +0.2 -0 mm.

INSTALLATION PRECAUTIONS

- the thickness of the panel must be between 0.8 and 5.0 mm (1/32 and 1/16 in)
- the maximum clamping torque applicable to the screwed-in brackets is 10 cNm
- ensure that the working conditions are within the limits stated in the **TECHNICAL SPECIFICATIONS** section
- do not install the device close to heat sources, equipment with a strong magnetic field, in places subject to direct sunlight, rain, damp, excessive dust, mechanical vibrations or shocks
- in compliance with safety regulations, the device must be installed properly to ensure adequate protection from contact with electrical parts. All protective parts must be fixed in such a way as to need the aid of a tool to remove them.

2 ELECTRICAL CONNECTION

- N.B.**
- use cables of an adequate section for the current running through them
 - ensure that the thermocouple is properly insulated from contact with metal parts or use already insulated thermocouples
 - if necessary, extend the thermocouple cables using compensating cables
 - where they are two multi-purpose inputs, multi-purpose input 1 has priority over multi-purpose input 2
 - the TTL MODBUS port can be used as an alternative to the USB port and vice versa
 - to reduce any electromagnetic interference locate the power cables as far away as possible from the signal cables.

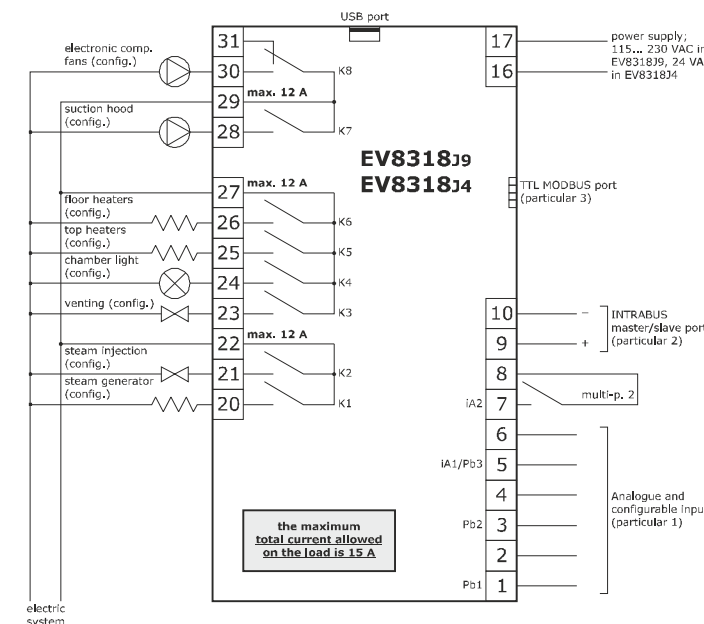

Particular 1

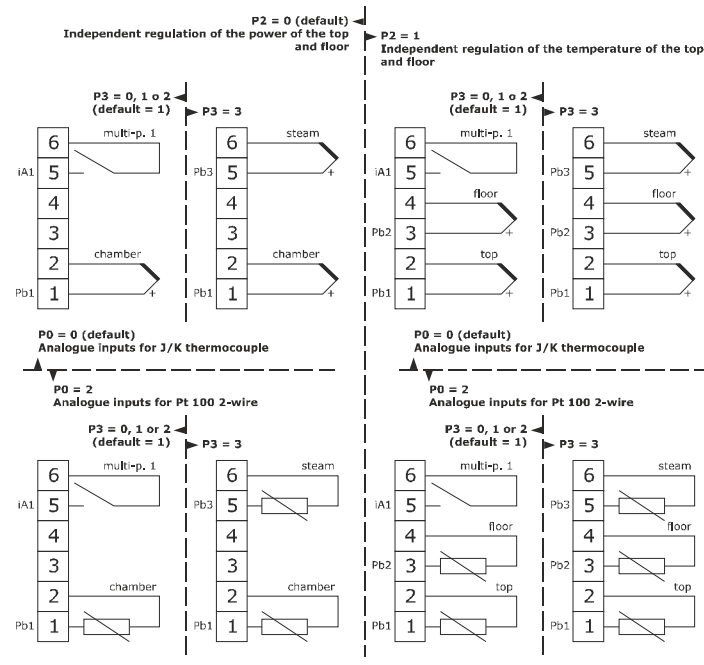

Particular 2

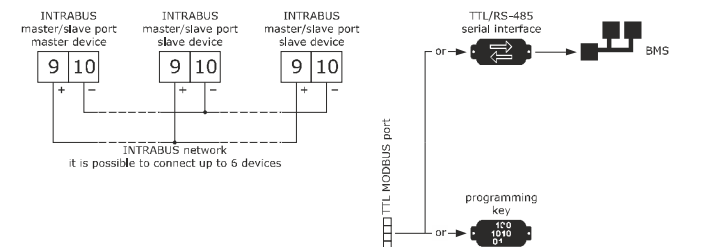

PRECAUTIONS FOR ELECTRICAL CONNECTION

- if using an electrical or pneumatic screwdriver, adjust the tightening torque
- if the device is moved from a cold to a warm place, humidity may cause condensation to form inside. Wait for about an hour before switching on the power
- make sure that the supply voltage, electrical frequency and power are within the set limits. See the section **TECHNICAL SPECIFICATIONS**
- disconnect the power supply before carrying out any type of maintenance
- do not use the device as a safety device
- for repairs and for further information, contact the EVCO sales network.

3 FIRST-TIME USE

1. Carry out the installation following the instructions given in the section **MEASUREMENTS AND INSTALLATION**.
2. Power up the device as set out in the section **ELECTRICAL CONNECTION**: an internal test will start up. The test normally takes a few seconds; when it is finished the display will switch off.
3. Configure the device as shown in the section **Setting configuration parameters**.

Recommended configuration parameters for first-time use:

PAR.	DEF.	PARAMETER	MIN... MAX.
P0	0	type of probe	0 = J 1 = K 2 = Pt 100 2-wire
P1	0	unit of measurement	0 = °C 1 = °F
P2	0	operating logic	0 = independent regulation of the top and floor power 1 = independent regulation of the top and floor temperature
r3	130	default chamber setpoint when configuring a phase	r1... r2 if P2 = 1, top setpoint
r6	130	default floor setpoint when configuring a phase	r4... r5

Then check that the remaining settings are appropriate; see the section **CONFIGURATION PARAMETERS**.

4. Disconnect the device from the mains.
5. Make the electrical connection as shown in the section **ELECTRICAL CONNECTION** without powering up the device.
6. When connecting to an RS-485 network, connect the EVIF22TSX interface. See the relative instruction sheets.
7. Power up the device.

4 USER INTERFACE AND MAIN FUNCTIONS

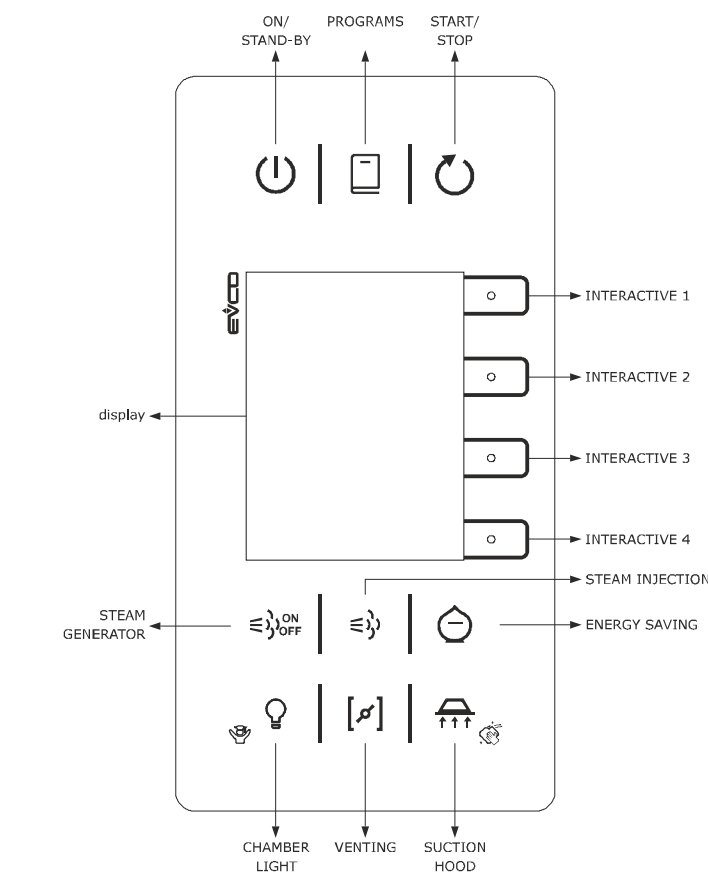

4.1 Switching the device on/off

- To switch the device on:
1. Touch the ON/STAND-BY key.
- To switch the device off:
1. Touch the ON/STAND-BY key for 3 s.
- If the device is on and the operating logic has independent regulation of the top and floor power (P2 = 0, default), the display will show:

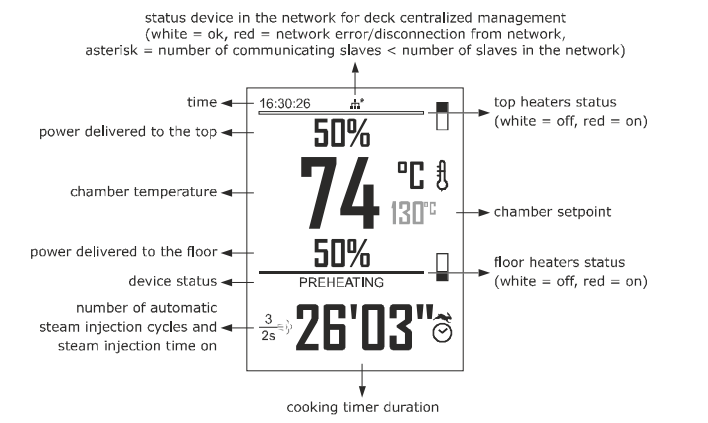

If the chamber setpoint has been reached, the status of the device will show "READY", if not, it will show "PRE-HEATING".

If the device is on and the operating logic has independent regulation of the top and floor temperature (P2 = 1), the display will show:

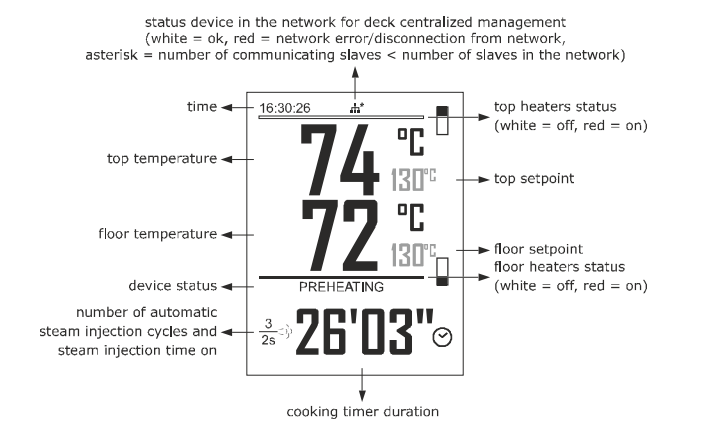

If the top and floor setpoints have been reached, the status of the device will show "READY", if not, it will show "PRE-HEATING".

If the device is switched off, the display will show the time. If the weekly programmed switch-on function is activated, the display will also show the day and time of the next switch-on and the programme that will start.

If the status of the device shows an alarm code, see the section **ALARMS**.

4.2 Starting up/interrupting the cooking cycle

- To start up a cooking cycle:
- make sure that the device is switched on
 - make sure that the cooking timer is set
1. Touch the START/STOP key: the cooking timer will start up and the status of the device will show "COOKING". When the timer stops, it will show "END".

To interrupt the cooking cycle:

1. Touch the START/STOP key for 1 s.

4.3 Setting the cooking timer

- Make sure that the device is switched on.
1. Touch the INTERACTIVE 4 key: the display will show the minutes in yellow.
 2. Touch the INTERACTIVE 1 key or the INTERACTIVE 2 key within 15 s to set the value.
 3. Touch the INTERACTIVE 3 key: the display will show the seconds in yellow.
 4. Touch the INTERACTIVE 1 key or the INTERACTIVE 2 key within 15 s to set the value.
 5. Touch the INTERACTIVE 3 key (or take no action for 15 s).

- Touch the INTERACTIVE 4 key to exit the procedure beforehand (any changes made will not be saved).

4.4.1 Setting the chamber setpoint (if P2 = 0)

Make sure that the device is switched on.

- Touch the INTERACTIVE 2 key: the display will show the value in yellow.
- Touch the INTERACTIVE 1 key or the INTERACTIVE 2 key within 15 s to set the value within the limits r1 and r2 (default "0...300").
- Touch the INTERACTIVE 3 key (or take no action for 15 s).
- Touch the INTERACTIVE 4 key to exit the procedure beforehand (any changes made will not be saved).

4.4.2 Setting the top and floor setpoints (if P2 = 1)

To set the floor setpoint:

- make sure that the device is switched on

- Touch the INTERACTIVE 1 key: the display will show the value in yellow.
- Touch the INTERACTIVE 1 key or the INTERACTIVE 2 key within 15 s to set the value within the limits r1 and r2 (default "0...300").
- Touch the INTERACTIVE 3 key (or take no action for 15 s).
- Touch the INTERACTIVE 4 key to exit the procedure beforehand (any changes made will not be saved).

To set the floor setpoint:

- make sure that the device is switched on

- Touch the INTERACTIVE 3 key: the display will show the value in yellow.
- Touch the INTERACTIVE 1 key or the INTERACTIVE 2 key within 15 s to set the value within the limits r1 and r2 (default "0...300").
- Touch the INTERACTIVE 3 key (or take no action for 15 s).
- Touch the INTERACTIVE 4 key to exit the procedure beforehand (any changes made will not be saved).

4.5 Setting the power delivered to the top and floor (if P2 = 0)

The power delivered means the switch-on time of the top and floor heaters, calculated as a percentage of the cycle time r8.

To set the power delivered to the top:

- make sure that the device is switched on

- Touch the INTERACTIVE 1 key: the display will show the value in yellow.
- Touch the INTERACTIVE 1 key or the INTERACTIVE 2 key within 15 s to set the value.
- Touch the INTERACTIVE 3 key (or take no action for 15 s).
- Touch the INTERACTIVE 4 key to exit the procedure beforehand (any changes made will not be saved).

To set the power delivered to floor:

- make sure that the device is switched on

- Touch the INTERACTIVE 3 key: the display will show the value in yellow.
- Touch the INTERACTIVE 1 key or the INTERACTIVE 2 key within 15 s to set the value.
- Touch the INTERACTIVE 3 key (or take no action for 15 s).
- Touch the INTERACTIVE 4 key to exit the procedure beforehand (any changes made will not be saved).

4.6 Switching the steam generator on/off (if u1c... u8c = 4)

Make sure that the device is switched on.

- Touch the STEAM GENERATOR key.

4.7 Steam injection (if u1c... u8c = 5)

If a cooking cycle is not active:

- make sure that the device is switched on
- make sure that the steam generator is switched on

- Touch the STEAM INJECTION key without releasing it.

The injector will be activated for as long as they key is held down.

If a cooking cycle is active:

- make sure that the steam generator is switched on

- Touch the STEAM INJECTION key.

The injector will automatically be activated for the time t8 (remaining off for the time t9) multiplied by the number of cycles t10.

If P3 = 2, the injector will be activated provided the function of the multi-purpose input 1 or 2 is "enable steam injection" (I1 or I4 = 6) and that the input is active.

If P3 = 3, the injector will be activated provided the temperature of the steam is no lower than the threshold t3.

To automatically activate the injector at start-up of cooking cycle:

- make sure that the device is switched on
- make sure that the steam generator is switched on

- Touch the STEAM INJECTION key.

2. Start up the cooking cycle.

To quickly set times t8, t9 and the number of cycles t10:

- make sure that the device is switched on

- Touch the STEAM GENERATOR key for 3 s: the display will show the "Steam" menu.
 - Touch the INTERACTIVE 1 key or the INTERACTIVE 2 key within 15 s to select a label (the availability of the labels depends on parameter t7).
- | LABEL | DESCRIPTION |
|------------|--|
| T On | t8 (steam injection time on) |
| T Off | t9 (steam injection time off) |
| Cycles | t10 (number of steam injection automatic cycles) |
| Steam gen. | status of steam generator at start-up of cooking cycle (on, off, man. = the same status as the previous phase) |
- Touch the INTERACTIVE 3 key: the display will show the value in yellow.
 - Touch the INTERACTIVE 1 key or the INTERACTIVE 2 key within 15 s to set the value.
 - Touch the INTERACTIVE 3 key (or take no action for 15 s).
 - Touch the INTERACTIVE 4 key to exit the procedure beforehand (any changes made will not be saved).

4.8 Opening/closing the vent (if u1c... u8c = 6)

Make sure that the device is switched on.

- Touch the VENTING key.

To set the amount of time for the vent to open in advance at the end of the cooking cycle:

- make sure that the device is switched on
- make sure that a cooking cycle is not active

- Touch the VENTING key for 3 s: the display will show the "Venting" menu.
- Touch the INTERACTIVE 3 key: the display will show the minutes in yellow.
- Touch the INTERACTIVE 1 key or the INTERACTIVE 2 key within 15 s to set the value or a label.

LABEL	DESCRIPTION
opn	vent open during the cooking cycle and for time u1 at the end of the cycle
clo	vent closed during the cooking cycle and at the end of the cycle

- Touch the INTERACTIVE 3 key: the display will show the seconds in yellow.
- Touch the INTERACTIVE 1 key or the INTERACTIVE 2 key within 15 s to set the value.
- Touch the INTERACTIVE 3 key (or take no action for 15 s).
- Touch the INTERACTIVE 4 key to exit the procedure beforehand (any changes made will not be saved).

4.9 Switching the chamber light on/off (if u1c... u8c = 3)

- Touch the CHAMBER LIGHT key.

4.10 Switching the suction hood on/off (if u1c... u8c = 7)

Make sure that the device is switched on.

- Touch the SUCTION HOOD key.

The hood remains on at maximum for the time u2.

If u2 = 0, touch the SUCTION HOOD again to switch the hood off.

4.11 Keypad lock (cleaning the device)

- Touch the SUCTION HOOD key for 3 s: the display will show "Cleaning controller" and the remaining count of the time c10.

4.12 Silencing the buzzer

Touch a key.

If u1c... u8c = 10, the buzzer is silenced.

5 ADDITIONAL FUNCTIONS

5.1 Activating/deactivating overheating

- make sure that the device is switched on
- make sure that parameter P2 is set to 0 (default)
- make sure that a cooking cycle is not active
- make sure that the energy saving function is not active

- Touch the INTERACTIVE 4 key for 3 s.

When overheating is activated, the top and floor heaters remain on in continuous mode until they reach the threshold c7.

5.2 Activating/deactivating the energy saving function

- make sure that the device is switched on
- make sure that the overheating function is not active

- Touch the ENERGY SAVING key.

If the operating logic has independent regulation of the top and floor power (P2 = 0, default), when the energy saving function is active, the switch-on time of the top and floor heaters is reduced by the percentage c9.

To quickly set the percentage reduction c9:

- make sure that the device is switched on

- Touch the ENERGY SAVING key for 3 s: the display will show the value in yellow.
- Touch the INTERACTIVE 1 key or the INTERACTIVE 2 key within 15 s to set the value.
- Touch the INTERACTIVE 3 key (or take no action for 15 s).

If the operating logic has independent regulation of the top and floor temperature (P2 = 1), when the energy saving function is active, the switch-on time of the top and floor heaters is calculated as 50% of the cycle time r8.

The energy saving function remains active at maximum for the time c8.

5.3 Setting the language

Make sure that the device is switched on.

- Touch the INTERACTIVE 4 key: the display will show the "Configuration" menu.
- Touch the INTERACTIVE 1 key or the INTERACTIVE 2 key to select "Language".
- Touch the INTERACTIVE 3 key: the display will show the "Language" menu.
- Touch the INTERACTIVE 1 key or the INTERACTIVE 2 key to select a language.
- Touch the INTERACTIVE 3 key.
- Touch the INTERACTIVE 4 key to exit the procedure (or take no action for 60 s).

5.4 Display of device status

Make sure that the device is switched on.

- Touch the CHAMBER LIGHT key for 3 s: the display will show the "Expert" menu.
- Touch the INTERACTIVE 1 key or the INTERACTIVE 2 key to select "Internal values" or "Alarms".
- Touch the INTERACTIVE 3 key.
- Touch the INTERACTIVE 4 key to exit the procedure (or take no action for 60 s).

6 DECK CENTRALIZED MANAGEMENT

6.1 Initial information

The deck centralized management makes it possible not to exceed the maximum power consumption allowed by your electric system. At the same time, an evenly distributed use of all decks and priority in the management of the interconnected loads are both ensured.

Priority in the management of the interconnected loads:

- Steam generator, chamber light and suction hood (immediate priority).
- Loads of devices temporarily excluded by the centralized management.
- Loads of devices with overheating function active.
- Loads of remaining devices. The priority depends on the error between the working point and the measured value.

It is possible to connect in the network up to 6 devices.

6.2 Deck centralized management

For all devices:

- make sure the device is connected to the network as shown in the section **ELECTRICAL CONNECTION**
- set an univocal INTRABUS address (parameter MS1); it is possible to connect 1 master device (MS1 = 1) and up to 5 slave devices (MS1 = 2... 6)
- enable the deck centralized management (parameter MS2 = 1)
- activate the deck centralized management after power-on (parameter MS3 = 1)
- set the power absorbed from top (parameter Pt)
- set the power absorbed from floor (parameter Pf)
- set the power absorbed by the chamber light (parameter Pbl).

For the master device:

- set the number of devices in the network (parameter MS6)
- set the available power in the electric system (parameter Pow)
- set the power absorbed from the suction hood (parameter Ph)
- set the power absorbed from the steam generator (parameter Pbs)
- set the type of steam generator (parameter Pbt)
- set the interval for interval for power distribution recalculation (parameter MS5)
- set the difference between the number of slave in the network and the number of those communicating (parameter MS7) such as to provoke the activation of protections in the master (loads switch off).

For the slave devices:

- set the consecutive time without communication without communication with the master such as to provoke the independent regulation (parameter MS4).

6.3 Activate deck centralized management

- Touch the ENERGY SAVING key.

6.4 Temporary exclusion of a device from the deck centralized management

- Touch the ENERGY SAVING key for 3 s.

7 PROGRAMS

7.1 Initial information

It is possible to save up to 50 programs. To start up the cooking cycle with the settings stored in the program, touch the START/STOP key.

Each program can consist of one or two cooking phases.

To add the second phase:

- make sure that the device is switched on

- Touch the CHAMBER LIGHT key for 3 s: the display will show the "Expert" menu.
- Touch the INTERACTIVE 1 key or the INTERACTIVE 2 key to select "Add phase".
- Touch the INTERACTIVE 3 key.
- Touch the INTERACTIVE 4 key to exit the procedure (or take no action for 60 s).

To configure a phase:

- make sure that the device is switched on

- Touch the CHAMBER LIGHT key for 3 s: the display will show the "Expert" menu.
- Touch the INTERACTIVE 1 key or the INTERACTIVE 2 key to select a phase.
- Touch the INTERACTIVE 3 key.

- Configure the device as shown in the previous paragraphs.

To delete the second phase:

- make sure that the device is switched on

- Touch the CHAMBER LIGHT key for 3 s: the display will show the "Expert" menu.
- Touch the INTERACTIVE 1 key or the INTERACTIVE 2 key to select "Delete phase".
- Touch the INTERACTIVE 3 key.
- Touch the INTERACTIVE 3 key again.
- Touch the INTERACTIVE 4 key to exit the procedure (or take no action for 60 s).

7.2 Storing a program

Configure the device as shown in the previous paragraphs.

- Touch the PROGRAMS key for 3 s: the display will show the "Programs" menu, "Programs" appears in yellow.
- Touch the INTERACTIVE 1 key or the INTERACTIVE 2 key to select a position, any previously stored programs will be overwritten.
- Touch the INTERACTIVE 3 key: "Programs" will become white.
- Touch the INTERACTIVE 4 key to exit the procedure (or take no action for 60 s).

7.3 Starting a program

Make sure that the device is switched on.

- Touch the PROGRAMS key: the display will show the "PROGRAMS" menu.
- Touch the INTERACTIVE 1 key or the INTERACTIVE 2 key to select a program.
- Touch the INTERACTIVE 3 key: the program will start up, the status of the device will show the name of the program.
- Touch the INTERACTIVE 4 key to exit the procedure (or take no action for 60 s).

7.4 Deleting a program

Make sure that the device is switched on.

- Touch the PROGRAMS key: the display will show the "Programs" menu.
- Touch the INTERACTIVE 1 key or the INTERACTIVE 2 key to select a program.
- Touch the INTERACTIVE 4 key for 3 s.
- Touch the INTERACTIVE 3 key.
- Touch the INTERACTIVE 4 key to exit the procedure (or take no action for 60 s).

8 WEEKLY PROGRAMMED SWITCH-ON

8.1 Initial information

It is possible to save up to 9 weekly programmed switch-ons. A program will start up when the device is switched on. To start up the cooking cycle with the settings stored in the program, touch the START/STOP key.

8.2 Storing a switch-on

- make sure that parameter C5 is set to 1 (default)
- make sure that at least one program has been stored
- make sure that the device is switched off

- Touch the INTERACTIVE 3 key.
- Touch the INTERACTIVE 1 key or the INTERACTIVE 2 key to select "Add switch-on".
- Touch the INTERACTIVE 3 key.
- Touch the INTERACTIVE 1 key or the INTERACTIVE 2 key to select "Day".
- Touch the INTERACTIVE 3 key: the display will show the day in yellow.
- Touch the INTERACTIVE 1 key or the INTERACTIVE 2 key within 15 s to set the value.
- Touch the INTERACTIVE 3 key (or take no action for 15 s).
- Touch the INTERACTIVE 1 key or the INTERACTIVE 2 key to select "Time".
- Touch the INTERACTIVE 3 key: the display will show the time in yellow.
- Touch the INTERACTIVE 1 key or the INTERACTIVE 2 key within 15 s to set the value.
- Touch the INTERACTIVE 3 key: the display will show the minutes in yellow.
- Touch the INTERACTIVE 1 key or the INTERACTIVE 2 key within 15 s to set the value.
- Touch the INTERACTIVE 3 key (or take no action for 15 s).
- Touch the INTERACTIVE 1 key or the INTERACTIVE 2 key to select "Program".
- Touch the INTERACTIVE 3 key: the display will show the program in yellow.
- Touch the INTERACTIVE 1 key or the INTERACTIVE 2 key within 15 s to set the value.
- Touch the INTERACTIVE 3 key (or take no action for 15 s).
- Touch the INTERACTIVE 1 key or the INTERACTIVE 2 key to select "Save".
- Touch the INTERACTIVE 3 key.
- Touch the INTERACTIVE 4 key to exit the procedure (or take no action for 60 s).

8.3 Activating the switch-ons

1. Switch off the device.
2. Touch the INTERACTIVE 1 key or the INTERACTIVE 2 key to select a switch-on.
3. Touch the START/STOP key: the display will show the day and time of the next switch-on and the program that will start.
 Touch the ON/STAND-BY key to switch the device off without activating the switch-ons.

8.4 Changing a switch-on

Make sure that the device is switched off.

1. Touch the INTERACTIVE 3 key.
2. Touch the INTERACTIVE 1 key or the INTERACTIVE 2 key to select "Switch-ons".
3. Touch the INTERACTIVE 3 key: the display will show the switch-ons in yellow.
4. Touch the INTERACTIVE 1 key or the INTERACTIVE 2 key to select a switch-on.
5. Touch the INTERACTIVE 3 key.
6. Touch the INTERACTIVE 4 key to exit the procedure (or take no action for 60 s).

8.5 Deleting a switch-on

Make sure that the device is switched off.

1. Touch the INTERACTIVE 3 key.
2. Touch the INTERACTIVE 1 key or the INTERACTIVE 2 key to select "Switch-ons".
3. Touch the INTERACTIVE 3 key: the display will show the switch-ons in yellow.
4. Touch the INTERACTIVE 1 key or the INTERACTIVE 2 key to select a switch-on.
5. Touch the INTERACTIVE 3 key.
6. Touch the INTERACTIVE 1 key or the INTERACTIVE 2 key to select "Delete switch-on".
7. Touch the INTERACTIVE 3 key.
8. Touch the INTERACTIVE 3 key again.
9. Touch the INTERACTIVE 4 key to exit the procedure (or take no action for 60 s).

9 SETTINGS

9.1 Setting configuration parameters

N.B.
Changing parameter P2 causes the value of the parameters whose unit of measurement is °C or °F to be changed automatically.

Make sure that the device is switched off.

1. Touch the INTERACTIVE 4 key: the display will show the "Configuration" menu.
2. Touch the INTERACTIVE 1 key or the INTERACTIVE 2 key to select "Service".
3. Touch the INTERACTIVE 3 key: the display will show "Password" in yellow.
4. Touch the INTERACTIVE 1 key or the INTERACTIVE 2 key within 15 s to set "-19".
5. Touch the INTERACTIVE 3 key: the display will show the "Service" menu.
6. Touch the INTERACTIVE 1 key or the INTERACTIVE 2 key to select a parameter.
7. Touch the INTERACTIVE 3 key: the display will show the parameter in yellow.
8. Touch the INTERACTIVE 1 key or the INTERACTIVE 2 key within 15 s to set the value.
9. Touch the INTERACTIVE 3 key (or take no action for 15 s).
10. Touch the INTERACTIVE 4 key to exit the procedure (or take no action for 60 s).

9.2 Setting the time and day of the week

N.B.
Do not disconnect the device from the mains in the two minutes after setting the time and day of the week.

Make sure that the device is switched off.

1. Touch the INTERACTIVE 4 key: the display will show the "Configuration" menu.
2. Touch the INTERACTIVE 1 key or the INTERACTIVE 2 key to select "Clock".
3. Touch the INTERACTIVE 3 key.
4. Touch the INTERACTIVE 1 key or the INTERACTIVE 2 key to select "Time".
5. Touch the INTERACTIVE 3 key: the display will show the time in yellow.
6. Touch the INTERACTIVE 1 key or the INTERACTIVE 2 key within 15 s to set the value.
7. Touch the INTERACTIVE 3 key: the display will show the minutes in yellow.
8. Touch the INTERACTIVE 1 key or the INTERACTIVE 2 key within 15 s to set the value.
9. Touch the INTERACTIVE 3 key (or take no action for 15 s).
10. Touch the INTERACTIVE 1 key or the INTERACTIVE 2 key to select "Day".
11. Touch the INTERACTIVE 3 key: the display will show the day in yellow.
12. Touch the INTERACTIVE 1 key or the INTERACTIVE 2 key within 15 s to set the value.
13. Touch the INTERACTIVE 3 key (or take no action for 15 s).
14. Touch the INTERACTIVE 4 key to exit the procedure (or take no action for 60 s).

9.3 Restoring factory settings (default)

N.B.
Check that the factory settings are appropriate; see the section CONFIGURATION PARAMETERS.

Make sure that the device is switched off.

1. Touch the INTERACTIVE 4 key: the display will show the "Configuration" menu.
2. Touch the INTERACTIVE 1 key or the INTERACTIVE 2 key to select "Service".
3. Touch the INTERACTIVE 3 key: the display will show "Password" in yellow.
4. Touch the INTERACTIVE 1 key or the INTERACTIVE 2 key within 15 s to set "149".
5. Touch the INTERACTIVE 3 key: the display will show the "Service" menu.
6. Touch the INTERACTIVE 1 key or the INTERACTIVE 2 key to select "Restore default".
7. Touch the INTERACTIVE 3 key for 3 s: the display will show a tick.

8. Touch the INTERACTIVE 4 key to exit the procedure beforehand (the reset will not be carried out).

10 CONFIGURATION PARAMETERS

N.	PAR.	DEF.	ANALOGUE INPUTS	MIN... MAX.
1	P0	0	type of probe	0 = J 1 = K 2 = Pt 100 2-wire
2	P1	0	unit of measurement	0 = °C 1 = °F
3	P2	0	operating logic	0 = independent regulation of the top and floor power 1 = independent regulation of the top and floor temperature
4	P3	1	type of steam injection	0 = disabled 1 = manual and automatic (with t8, t9 and t10) if generator is on 2 = manual and automatic (with t8, t9 and t10), with digital input active and if generator is on 3 = manual and automatic (with t8, t9 and t10), thermoregulated (with t1, t2 and t3) and if generator is on
5	CA1	0	chamber probe offset	-25... 25 °C/°F if P2 = 1, top probe offset
6	CA2	0	floor probe offset	-25... 25 °C/°F
7	CA3	0	steam probe offset	-25... 25 °C/°F
N.	PAR.	DEF.	REGULATION	MIN... MAX.
8	r0	5	setpoint chamber differential	1... 99 °C/°F if P2 = 1, top setpoint and floor setpoint differential effective if r10 = 0
9	r1	0	minimum chamber setpoint	0 °C/°F... r2 if P2 = 1, minimum top setpoint
10	r2	300	maximum chamber setpoint	r1... 999 °C/°F if P2 = 1, maximum top setpoint
11	r3	130	default chamber setpoint when configuring a phase	r1... r2 if P2 = 1, top setpoint
12	r4	0	minimum floor setpoint	0 °C/°F... r5
13	r5	300	maximum floor setpoint	r4... 999 °C/°F
14	r6	130	default floor setpoint when configuring a phase	r4... r5
15	r7	0	constraint between top and floor powers	0 = disabled 1 = changing a power causes the other to be changed automatically so that the sum of the two is always 100
16	r8	80	cycle time for top and floor heaters on	1... 999 s if P2 = 1, cycle time for top and floors heaters on in energy saving mode if P2 = 1 and r10 > 0, cycle time PI
17	r9	0	minimum time top and floor heaters on and off	0... 240 s we recommend > 10 s
18	r10	50	proportional band	0... 99 °C/°F 0 = on-off control effective only if P2 = 1
19	r11	80	integral action time	0... 999 s 0 = P control effective only if P2 = 1
N.	PAR.	DEF.	GENERAL SETTINGS	MIN... MAX.
20	c0	15	time buzzer on from end of cooking cycle	-1... 120 s -1 = until silencing
21	c1	0	activate buzzer for 1 s at end of the cooking phase	0 = no 1 = yes
22	c2	60	keyboard inactivity time to switch off the device from weekly programmed switch-on activation	0... 240 min 0 = disabled
23	c3	10	high chamber temperature threshold for locked display (relative to chamber setpoint)	0... 99 °C/°F chamber setpoint + c3 0 = disabled
24	c4	10	low chamber temperature threshold for locked display (relative to chamber setpoint)	0... 99 °C/°F chamber setpoint - c4 0 = disabled
25	c5	1	enable weekly programmed switch-on	0 = no 1 = yes
26	c6	0	activate overheating at power-on	0 = no 1 = yes effective only if P2 = 0
27	c7	150	chamber temperature threshold for end of overheating	0... 999 °C/°F 0 = on reaching the working setpoint effective only if P2 = 0
28	c8	60	maximum duration of energy saving	0... 240 min 0 = until manual deactivation not effective if activated by digital input
29	c9	50	percentage reduction time top and floor heaters on in energy saving mode	0... 100 % effective only if P2 = 0
30	c10	10	duration of controller cleaning	1... 120 s
31	c11	0	setting used at end of the cooking phase	0 = setting phase 1 1 = last settings
32	c12	0	deactivate the energy saving switching the device off	0 = yes 1 = no
N.	PAR.	DEF.	STEAM INJECTION	MIN... MAX.
33	t1	100	steam setpoint	0... 500 °C/°F
34	t2	5	steam setpoint differential	1... 99 °C/°F
35	t3	50	steam temperature threshold for injection stoppage (relative to steam setpoint)	0... 999 °C/°F steam setpoint - t3 injection available on reaching steam setpoint
36	t4	1	activate automatic steam injection cycles at start-up of cooking cycle	0 = no 1 = yes
37	t5	1	deactivate automatic steam injection cycles at end of cooking cycle	0 = no 1 = yes
38	t6	0	steam generator on at power-on	0 = no 1 = yes
39	t7	2	time available with quick setting of automatic steam injection cycles	0 = injection time on 1 = injection time on and injection time off 2 = injection time on, injection time off and number of automatic cycles 3 = injection time on and number of automatic cycles
40	t8	2	steam injection default time on with quick setting	1... 99 s
41	t9	10	steam injection default time off with quick setting	1... 999 s if t7 = 1 or 2, injection time off

N.	PAR.	DEF.	ALARMS	MIN... MAX.
42	t10	3	number of automatic steam injection cycles default	-1... 20 -1 = until generator is switched off if t7 = 0 or 1, number of automatic cycles
N.	PAR.	DEF.	DIGITAL INPUTS	MIN... MAX.
43	A0	10	temperature alarm switch off differential	1... 99 °C/°F
44	A1	0	high temperature alarm threshold	0... 500 °C/°F
45	A2	0	high temperature alarm delay and delay after modifying setpoint	0... 240 min
46	A3	0	high temperature alarm type	0 = disabled 1 = absolute 2 = relative to setpoint
47	A4	70	high operating temperature alarm threshold	0... 88 °C/175 °F
48	A5	240	power failure duration due to interruption of cooking cycle	0 = disabled
N.	PAR.	DEF.	DIGITAL INPUTS	MIN... MAX.
49	i0	0	activation multi-purpose input 1	0 = with contact closed 1 = with contact open
50	i1	4	multi-purpose input 1 function (option 6 effective only if P3 = 2)	0 = disabled 1 = suction hood on (door open alarm) 2 = steam injection off, top and floor heaters off, suction hood on (door open alarm) 3 = switches device on/off 4 = steam generator off, top and floor heaters off (thermal switch alarm) 5 = energy saving activation/deactivation 6 = enable steam injection 7 = steam injection
51	i2	0	door open alarm delay and thermal switch alarm delay from multi-purpose input 1	0... 120 s
52	i3	0	multi-purpose input 2 activation	0 = with contact closed 1 = with contact open
53	i4	6	multi-purpose input 2 function (option 6 effective only if P3 = 2)	0 = disabled 1 = suction hood on (door open alarm) 2 = steam injection off, top and floor heaters off, suction hood on (door open alarm) 3 = switches device on/off 4 = steam generator off, top and floor heaters off (thermal switch alarm) 5 = energy saving activation/deactivation 6 = enable steam injection 7 = steam injection
54	i5	0	door open alarm delay and thermal switch alarm delay from multi-purpose input 2	0... 120 s
N.	PAR.	DEF.	DIGITAL OUTPUTS	MIN... MAX.
55	u0	0	opening vent	0 = with contact closed 1 = with contact open
56	u1	10	time vent open from end of cooking cycle	0... 600 s -1 = open until closed by pressing key
57	u2	10	time suction hood on	0... 999 s 0 = switching on/off by key
58	u3	0	switch the chamber light on switching the device on	0 = yes 1 = no
59	u4	0	switch the chamber light off switching the device off	0 = yes 1 = no
60	u6	60	operating temperature threshold when electronics compartment fans on and device off	20... 65 °C/65... 150 °F fans always on with device on and device sensor in alarm mode
61	u7	10	u6 differential	1... 99 °C/°F
62	u8	0	activate chamber light flashing for 10 s at end of the cooking cycle	0 = no 1 = yes
63	u1c	4	K1 output configuration	0 = disabled 1 = top heaters 2 = floor heaters 3 = chamber light 4 = steam generator 5 = steam injection 6 = venting 7 = suction hood 8 = electronics compartment fans 9 = on/stand-by 10 = sound
64	u2c	5	K2 output configuration	0 = disabled 1 = top heaters 2 = floor heaters 3 = chamber light 4 = steam generator 5 = steam injection 6 = venting 7 = suction hood 8 = electronics compartment fans 9 = on/stand-by 10 = sound
65	u3c	6	K3 output configuration	0 = disabled 1 = top heaters 2 = floor heaters 3 = chamber light 4 = steam generator 5 = steam injection 6 = venting 7 = suction hood 8 = electronics compartment fans 9 = on/stand-by 10 = sound
66	u4c	3	K4 output configuration	0 = disabled 1 = top heaters 2 = floor heaters 3 = chamber light 4 = steam generator 5 = steam injection 6 = venting 7 = suction hood 8 = electronics compartment fans 9 = on/stand-by 10 = sound

67	u5c	1	K5 output configuration	0 = disabled 1 = top heaters 2 = floor heaters 3 = chamber light 4 = steam generator 5 = steam injection 6 = venting 7 = suction hood 8 = electronics compartment fans 9 = on/stand-by 10 = sound
68	u6c	2	K6 output configuration	0 = disabled 1 = top heaters 2 = floor heaters 3 = chamber light 4 = steam generator 5 = steam injection 6 = venting 7 = suction hood 8 = electronics compartment fans 9 = on/stand-by 10 = sound
69	u7c	7	K7 output configuration	0 = disabled 1 = top heaters 2 = floor heaters 3 = chamber light 4 = steam generator 5 = steam injection 6 = venting 7 = suction hood 8 = electronics compartment fans 9 = on/stand-by 10 = sound
70	u8c	8	K8 output configuration	0 = disabled 1 = top heaters 2 = floor heaters 3 = chamber light 4 = steam generator 5 = steam injection 6 = venting 7 = suction hood 8 = electronics compartment fans 9 = on/stand-by 10 = sound

N.	PAR.	DEF.	MODBUS	MIN... MAX.
71	LA	247	MODBUS address	1... 247
72	Lb	3	MODBUS baud rate	0 = 2,400 baud 1 = 4,800 baud 2 = 9,600 baud 3 = 19,200 baud

N.	PAR.	DEF.	CENTRALIZED MANAGEMENT	MIN... MAX.
73	MS1	1	INTRABUS address	1... 6 1 = dispositivo master
74	MS2	0	enable deck centralized management	0 = no 1 = yes
75	MS3	0	activate deck centralized management after power-on	0 = no 1 = yes
76	MS4	30	consecutive time without communication with master for independent regulation	10... 240 s
77	MS5	30	interval for power distribution recalculation	5... 999 s
78	MS6	1	number of devices in the network	1... 6
79	MS7	1	difference between number of slaves in the network and number of slaves communicating for master protections (master loads off)	1... 5 if number of communicating slaves < MS6, the master assigns the not communicating slaves a power equivalent to its own
80	Pow	999	available power in the electric system	0... 999 KW
81	Pt	0	absorbed power from top	0... 9999 W x 10 for its deck
82	Pf	0	absorbed power from floor	0... 9999 W x 10 for its deck
83	Ph	0	absorbed power from the suction hood	0... 9999 W x 10 in common
84	Pb	0	absorbed power from the steam generator	0... 9999 W x 10 for its deck or in common
85	Pbt	0	steam generator type	0 = for its deck 1 = in common
86	Pbl	0	absorbed power from chamber light	0... 9999 W x 10 for its deck

11 ALARMS

LABEL	RESET	TO CORRECT
Chamber probe	automatic	- check P0
Top probe	automatic	- check the integrity of the probe
Floor probe	automatic	- check electrical connection
Steam probe	automatic	
Board probe	automatic	check operating temperature
time flashing	manual	set time and day of the week
Chamber high temp.	automatic	check A1 and A3
Top high temp.	automatic	check A1 and A3
Floor high temp.	automatic	check A1 and A3
Controller high temp.	automatic	check A4
Door	automatic	check i0, i1, i3 and i4
Power failure	manual	- touch a key - check A5 - check electrical connection
Thermal switch	manual	check i0, i1, i3 and i4
Top thermal switch	manual	check i0, i1, i3 and i4
Floor thermal switch	manual	check i0, i1, i3 and i4

12 TECHNICAL SPECIFICATIONS

Purpose of the control device:	function controller.
Construction of the control device:	built-in electronic device.
Housing:	black, self-extinguishing.
Category of heat and fire resistance:	D.
Measurements:	76.4 x 148.4 x 77.0 mm (3 x 5 13/16 x 3 in).
Mounting methods for the control device:	to be fitted to a panel, screwed-in brackets provided.
Degree of protection provided by the covering:	IP65 (front).
Connection method:	
plug-in screw terminal blocks for wires up to 2.5 mm ²	Pico-Blade connector female Micro USB connector.
Maximum permitted length for connection cables:	
power supply: 10 m (32.8 ft)	analogue inputs: 10 m (32.8 ft)
digital inputs: 10 m (32.8 ft)	digital outputs: 10 m (32.8 ft)
Operating temperature:	from 0 to 60 °C (from 32 to 140 °F).
Storage temperature:	from -25 to 70 °C (from -13 to 158 °F).
Operating humidity:	relative humidity without condensate from 10 to 90%.

Pollution status of the control device:	3.	
Compliance:		
RoHS 2011/65/EC	WEEE 2012/19/EU	REACH (EC) Regulation N. 1907/2006
EMC 2014/30/EU	LVD 2014/35/EU.	
Power supply:	115... 230 VAC (+10% -15%), 50/60 Hz (±3 Hz), max. in EV8318J9 24 VAC (+10% -15%), 50/60 Hz (±3 Hz), max. in EV8318J4	
Earthing methods for the control device:	none.	
Rated impulse-withstand voltage:	2.5 KV	
Over-voltage category:	II.	
Software class and structure:	A.	
Clock:	built-in secondary lithium battery.	
Clock drift:	≤ 60 s/month at 25 °C (77 °F).	
Clock battery autonomy in the absence of a power supply:	> 24 h at 25 °C (77 °F).	
Clock battery charging time:	24 h (the battery is charged by the power supply of the device).	
Analogue inputs:	2 for J/K thermocouples or Pt 100 2-wire probes (chamber probe or top and floor probes).	
J thermocouples:	Measurement field:	from 0 to 700 °C (from 32 to 999 °F).
	Resolution:	1 °C (1 °F).
K thermocouples:	Measurement field:	from 0 to 999 °C (from 32 to 999 °F).
	Resolution:	1 °C (1 °F).
Pt 100 probes:	Measurement field:	from 0 to 650 °C (from 32 to 999 °F).
	Resolution:	1 °C (1 °F).
Digital inputs:	1 dry contact (multi-purpose 2).	
Dry contact:	Contact type:	3.3 V, 1 mA
	Protection:	none.
Other inputs:	can be configured for analogue input (steam probe) or digital input (multi-purpose input 1).	
Digital outputs:	8 with electro-mechanical relay (K1...K8 relays). The maximum overall current permitted for loads is 15 A.	
K1 relay:	SPST, 16 A res. @ 250 VAC.	
K2...K7 relay :	SPST, 8 A res. @ 250 VAC.	
K8 relay:	SPDT, 8 A res. @ 250 VAC.	
Type 1 or Type 2 actions:	Type 1.	
Additional features of Type 1 or Type 2 actions:	C.	
Displays:	2.8 inch TFT colour graphic display.	
Alarm buzzer:	built-in.	
Built-in sensors:	1 (operating temperature).	
Communications ports:		
1 TTL MODBUS slave port for programming key or for BMS	1 INTRABUS master/slave port (deck centralized management)	1 USB port (set up recipe book).

N.B.
The device must be disposed of according to local regulations governing the collection of electrical and electronic equipment.

This document and the solutions contained therein are the intellectual property of EVCO and thus protected by the Italian Intellectual Property Rights Code (CPI). EVCO imposes an absolute ban on the full or partial reproduction and disclosure of the content other than with the express approval of EVCO. The customer (manufacturer, installer or end-user) assumes all responsibility for the configuration of the device. EVCO accepts no liability for any possible errors in this document and reserves the right to make any changes, at any time without prejudice to the essential functional and safety features of the equipment.