

# EVX Series Digital Controllers for Static and Ventilated Refrigeration Display Cabinets

## ENGLISH

### 1 IMPORTANT

#### 1.1 Important

Carefully read these instructions before installing and using the product. Pay close attention to the notes on installation and electrical wiring connections; save these instructions together with the instrument for future reference.

 The instrument must be disposed of in accordance with local laws on the collection of electrical and electronic equipment.

### 2 INTRODUCTION

#### 2.1 Introduction

EVX is a new range of digital controllers for the operation of static and ventilated refrigerating cabinets.

The series is composed of the following models:

- **EVX201** - for the operation of static refrigerated cabinets, with simple HACCP function
- **EVX203, EVX204 and EVX205** - for the operation of ventilated refrigerated cabinets, with simple HACCP function
- **EVX214 and EVX215** - for the operation of ventilated refrigerated cabinets, with timer, advanced HACCP function and an Energy Saving function.

EVX201 is equipped with:

- 1 measurement input (cell probe) for NTC probes
- 1 digital input (door microswitch)
- 1 digital output (relay) for compressor operation (16 A @ 250 VAC); defrosting occurs when the compressor is stopped.

EVX203 is equipped with:

- 2 measurement inputs (cell probe and evaporator probe) for NTC probes
- 1 digital input (door microswitch)
- 3 digital outputs (relay) for compressor operation (16 A @ 250 VAC), defrosting and the evaporator fan; defrosting may be either electrical or by hot gas.

EVX204 and EVX205 are equipped with:

- 3 measure inputs (cell probe, evaporator probe and condenser probe) for NTC probes
- 2 digital inputs (door microswitch and multifunction)
- 4 digital outputs (relay, 5 for EVX205) for operation of the compressor (30 A @ 250 VAC), defroster, the evaporator fan, a fourth and a fifth use (programmable as cell light, demister resistor, auxiliary output, output alarm, door resistor, evaporator valve or condenser fan); defrosting may be electric or by hot gas.

EVX214 and EVX215 are equipped with:

- Real Time Clock
- 3 measure inputs (cell probe, evaporator probe and condenser probe) for NTC probes
- 2 digital inputs (door microswitch and multifunction)
- 4 digital outputs (relay, 5 for EVX215) for operation of the compressor (30 A @ 250 VAC), defroster, the evaporator fan, a fourth and a fifth use (programmable as cell light, demister resistor, auxiliary output, output alarm, door resistor, evaporator valve or condenser fan); defrosting may be electric or by hot gas.

The models are open (without covers); the user interface consists of a 4 digit custom display (with decimal points and functional icons) and by six buttons (SET, UP, DOWN, DEFROST, AUXILIARY and ON/STAND-BY).

Installation is completed via back panel using M3 studs.

Using the EVKEY programming key (to be ordered separately) it is possible to carry out the uploading and downloading of the configuration parameters; it is also possible to connect the controllers RICS supervision system (via serial interface, via TTL, with MODBUS communications protocol).

### 3 DIMENSIONS AND INSTALLATION

#### 3.1 Dimensions

The dimensions are expressed in mm (in).

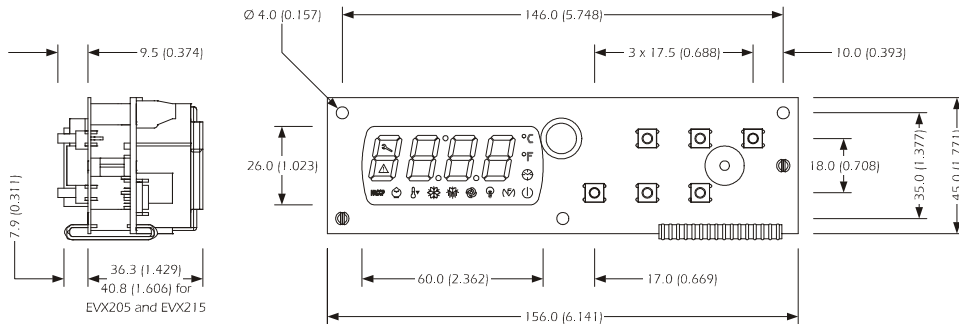

#### 3.2 Installation

Back panel installation using M3 studs.

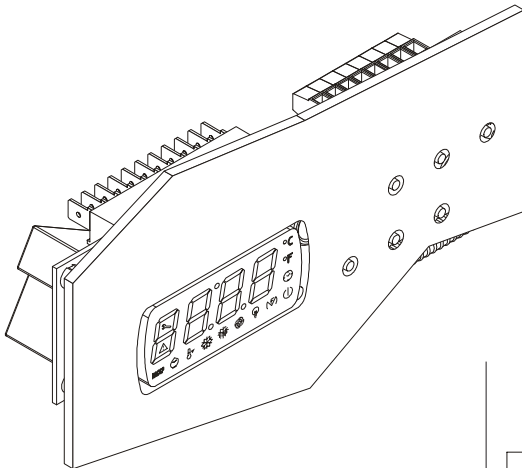

#### 3.3 Installation notes

- make sure that the working conditions (operating temperature, humidity, etc.) fall within the limits indicated in the technical specifications
- do not install the device near heat sources (resistors, hot air ducts, etc.), near devices with strong magnetic fields (large diffusers etc.) and places subject to direct sunlight, rain, humidity, excessive dust, mechanical vibrations or shaking
- in accordance with laws on safety, protection against possible contact with electrical parts must be ensured via the correct installation of the instrument; all the parts that ensure such protection must be secured in such a way that they cannot be removed without the using a special tool.

### 4 USER INTERFACE

#### 4.1 Preliminary signals

The user interface consists of a custom 4-digit display (with decimal points and function icons) and six keys (SET, UP, DOWN, DEFROST, AUXILIARY and ON/STAND-BY).

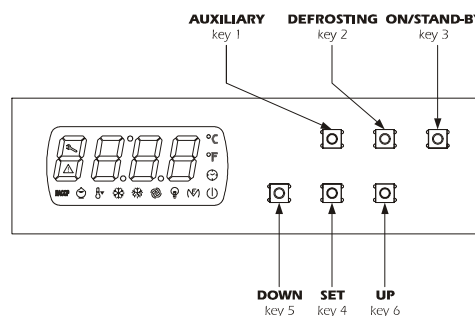

Operating Statuses:

- "on" status (the instrument is powered and on: the regulators can be switched on)
- "stand-by" status (the instrument is powered but is switched off via software: the regulators are switched off; the possibility to manually switch on/switch off the cell light or auxiliary output depends on parameter U2)
- "off" status (the instrument is not powered).

Hereafter, with the word "start-up" means the passage from stand-by status to on status; the word "shutdown" means the passage from on status to stand-by status.

When the power is switched back on, the instrument displays the status that it was in at the time it was disconnected.

#### 4.2 Manual switching on/off of the instrument

- make sure that the keyboard is not locked and that no other operation is in progress
- press and hold down the **ON/STAND-BY** key for 2 sec: the on/stand-by LED will switch off/on.

For EVX204, EVX214, EVX205 and EVX215:

Using the multifunction input it is possible to remotely switch on/off the instrument.

#### 4.3 The display

If the instrument is switched on, during normal operation, the display will show the cell temperature, except during defrosting, when the instrument will show the temperature established with parameter d6. If the instrument is switched off, the display will be switched off.

#### 4.4 Evaporator temperature display (but EVX201)

- make sure that the keyboard is not locked and that no other operation is in progress
- press down the **DOWN** key for 1 sec: the display will show the first available label
- press and release the **UP** or the **DOWN** key to select "Pb2"
- press and release the **SET** key.

To exit the procedure:

- press and release the **SET** key and do not operate for 60 sec
- press and release the **UP** key and the **DOWN** key until the display shows the cell temperature and then do not operate for 60 sec.

Alternatively:

- press and release the **ON/STAND-BY** key.
- If the evaporator probe is absent (parameter P3 = 0), the label "Pb2" will not be displayed.

#### 4.5 Condenser temperature display (EVX204, EVX214, EVX205 and EVX215 only)

- make sure that the keyboard is not locked and that no other operation is in progress
- press down the **DOWN** key for 1 sec: the display will show the first label available
- press and release the **UP** key or the **DOWN** key to select "Pb3"
- press and release the **SET** key.

To exit the procedure:

- press and release the **SET** key and then do not operate for 60 sec
- press and release the **UP** or **DOWN** key until the display shows the cell temperature and then do not operate for 60 sec.

Alternatively:

- press and release the **ON/STAND-BY** key.
- If the condenser probe is absent (parameter P4 = 0), the label "Pb3" will not be displayed.

#### 4.6 Activation/disactivation of Overcooling function

- make sure that the keyboard is not locked and that no other operation is in progress, that defrosting and/or dripping is not in progress and that the evaporator fan is off (the last two but EVX201)
- press and hold down the **UP** key for 4 sec: the Overcooling LED will light up.

During the Overcooling function the working setpoint is reduced by the temperature established with parameter r5; the operation lasts for the amount of time established with parameter r6. During Overcooling defrosting is never activated; if the defrosting interval expires when the function is in progress, defrosting will be activated at the end of the function.

#### 4.7 Manual Activation of Defrosting

- make sure that the keyboard is not locked and that no other operation is in progress; ensure that the Overcooling function is not in progress
- press and hold down the **DEFROSTING** key for 4 sec.

For EVX203, EVX204, EVX214, EVX205 and EVX215:

If the evaporator probe function is that of the defrosting probe (parameter P3=1) and upon activation of defrosting, the temperature of the evaporator is higher than that established with parameter d2, the defrosting function will not be activated.

#### 4.8 Operation for low or high percentage of relative humidity (but EVX201 and provided parameter F0 is set to 5)

During operation for low percentage of relative humidity, the evaporator ventilator will be switched on if the compressor is switched off (parameter F4 determines the amount of time it is switched off while parameter F5 determines the amount of time it is switched on). During operation for a high percentage of relative humidity the evaporator fan is always on.

**4.8.1 Manual activation of operation for low or high percentage of relative humidity (but EVX201 and provided parameter F0 is set to 5)**

- make sure that the keyboard is not locked and that no other procedures are in progress
- press the **SET** and the **UP** keys for 4 sec: the display will show "rhL" (operation for low percentage of relative humidity) or "rhH" (operation for high percentage of relative humidity) for 10 sec.

To restore the normal display before the operation is complete:

- press a key.

Activation of the operation for a low or high percentage of relative humidity can be done using parameter F6.

If parameter F0 is not set to 5, pressing the **SET** and the **UP** keys will cause the display of the following message "- - -" for 1 sec.

**4.8.2 Display of type of operation in progress (for low or high percentage of relative humidity, but EVX201 and provided that parameter F0 is set to 5)**

- make sure that no other procedure is in progress
- press and release the **SET** and the **UP** keys: the display will show "rhL" (operation for low percentage of relative humidity) or "rhH" (operation for high percentage of relative humidity) for 10 sec.

To restore the normal display before the operation is complete:

- press a key.

If parameter F0 is not set to 5, pressing the **SET** and **UP** keys will cause:

- the display of the message "- - -" for 1 sec if the keyboard is not locked
- display of the label "Loc" for 1 sec if the keyboard is locked.

**4.9 Manual switching on/off of the cell light (EVX204, EVX214, EVX205 and EVX215 only and provided that parameter u1 and/or parameter u11 is set to 0)**

- make sure that no other procedure is in progress
- press and release the **AUXILIARY** key : the LED light will switch on/off.

Using the door microswitch it is also possible to switch on/off the cell light by remote; see also parameter u2.

If parameter u1 is set at 0 (i.e. the utility managed by the fourth output is the cabinet light) and parameter u11 is set at 2 (i.e. the utility managed by the fifth output is the auxiliary output), holding the **AUXILIARY** key down for 2 s will cause the switch-on/off of the multipurpose LED and of the auxiliary output.

**4.10 Switching on the demisting resistors (EVX204, EVX214, EVX205 and EVX215 only and provided that parameter u1 and/or parameter u11 is set to 1)**

- ensure that the instrument is switched on and that no other procedure is in progress.
- press the **AUXILIARY** key for 2 sec: the multifunction LED will light up and the resistors will be switched on, both for the amount of time established with parameter u6.

Manually switching off the demisting resistors is not permitted (that is, before the time established with parameter u6 expires).

**4.11 Manually switch on/off of the Auxiliary output (EVX204, EVX214, EVX205 and EVX215 only and provided parameter u1 and/or parameter u11 is set to 2)**

- ensure that the keyboard is not locked and that no other procedure is in progress
- press and release the **AUXILIARY** key.

Using the multifunction input it is also possible to remotely switch on/off the auxiliary output.

If parameter u1 is set at 2 (i.e. the utility managed by the fourth output is the auxiliary output) and parameter u11 is set at 0 (i.e. the utility managed by the fifth output is the cabinet light), holding the **AUXILIARY** key down for 2 s will cause the switch-on/off of the cabinet light LED and of the cabinet light.

If the auxiliary output has been switched on manually, then it can also be switched off manually (similarly, if the auxiliary output has been remotely switched on, then it can only be switched off in the same manner); see also parameter u2.

**4.12 Energy Saving (but EVX201)**

During function Energy Saving the working setpoint is increased of the temperature you have set with parameter r4 and the evaporator fan is turned on cyclically, on condition that parameter F0 has value 1 or 2 (parameter F13 sets the time the fan remains turned off and parameter F14 the time it remains turned on).

Once the time you have set with parameter i10 has passed (without activations of the door switch digital input and on condition that the cabinet temperature has reached the working setpoint) function Energy Saving is activated automatically (as long as the input will be activated).

**4.12.1 Activation/deactivation of function Energy Saving with effect on the compressor only (EVX204, EVX214, EVX205 and EVX215)**

Through the multipurpose input it is possible to activate/deactivate function Energy Saving at a distance.

Function Energy Saving can be activated in real time too, to the time you have set with parameter HE1; in this case the duration of the function can be set through parameter HE2.

**4.13 Locking/unlocking the keyboard**

To lock the keyboard:

- make sure that no other procedure is in progress
- press and hold down the **DOWN** and **ON/STAND-BY** keys for 1 sec: the display will show the message "Loc" for 1 sec.

If the keyboard is locked, the following are not permitted:

- manual switch on/off of the instrument
- display of evaporator temperature (via the procedure explained in paragraph 4.4)
- display of the condenser temperature (via the procedure indicated in paragraph 4.5)
- activation/disactivation of Overcooling function
- manual activation of defrosting
- activation of operation for low of high percentage of relative humidity and learning the kind of operation
- manual switch on/off of the auxiliary output
- see information regarding the HACCP alarms
- cancellation of HACCP alarm list
- changing the date and time
- changing the working setpoint (with the procedure described in 5.2)
- display of compressor operation hours
- cancellation of compressor operation hours

The operations cause the display of the label "Loc" per 1 sec.

To unlock the keyboard:

- press and hold down the **DOWN** and **ON/STAND-BY** keys for 1 sec: the display will show the message "UnL" for 1 sec.

**4.13 Silencing the Buzzer**

- ensure that no other procedure is in progress
- press a key (the first pressing of the key will not cause the effect associated with that key).

For EVX204, EVX214, EVX205 and EVX215:

If parameter u1 and/or parameter u11 is set to 3 and parameter u4 is set to 1, pressing the key will also deactivate the alarm output.

If parameter u9 is set to 0, the buzzer will not be activated.

**5 SETTINGS**

**5.1 Setting the day and real time (EVX214 and EVX215 only)**

- ensure that the keyboard is not locked and that no other procedures are in progress
- press and hold down the **DOWN** key for 1 sec: the display will show the first label available
- press and release the **UP** or **DOWN** key to select "rtc".

To change the year:

- press and release the **SET** key: the display will show "yy" followed by the last two numbers in the year and the clock LED will flash
- press and release the **UP** or **DOWN** key within 15 sec.

To change the month:

- press and release the **SET** key while changing the year: the display will show "nn" followed by the two numbers of the month
- press and release the **UP** or **DOWN** key within 15 sec.

To change the day of the month:

- press and release the **SET** key while changing the month: the display will show "dd" followed by the two numbers of the day
- press and release the **UP** or **DOWN** key within 15 sec.

To change the hour:

- press and release the **SET** key while changing the day of the month: the display will show "hh" followed by the two numbers of the hour
- press and release the **UP** or **DOWN** key within 15 sec.

The hour is displayed using the 24 hour system.

To change the minutes:

- press and release the **SET** key while changing the hour: the display will show "mm" followed by the two minute numbers
- press and release the **UP** and **DOWN** keys within 15 sec
- press and release the **SET** key or do not operate for 15 sec: the clock LED will switch off.

To exit the procedure:

- press and release the **UP** or **DOWN** key until the display shows the cell temperature and then do not operate for 60 sec.

Alternatively:

- press and release the **ON/STAND-BY** key.

**5.2 Setting the working setpoint**

- ensure that the keyboard is not locked and that no other procedure is in progress.

- press and release the **SET** key: the compressor LED will flash
- press and release the **UP** or **DOWN** key within 15 sec; see also parameters r1, r2 and r3
- press and release the **SET** key or do not operate for 15 sec: the compressor LED will switch off and then the instrument will exit the procedure.

To exit the procedure before the operation is complete:

- do not operate for 15 sec (any changes will be saved).

The working setpoint can also be set via parameter SP.

**5.3 Setting the configuration parameters**

To begin the procedure:

- ensure that no other procedure is in progress
- hold down the **UP** and **DOWN** keys for 4 sec: the display will show "PA"
- press and release the **SET** key
- press and release the **UP** or **DOWN** key within 15 sec to set "-19"
- press and release the **SET** key or do not operate for 15 sec
- hold down the **UP** and **DOWN** keys for 4 sec: the display will show "SP".

To select a parameter:

- press and release the **UP** or **DOWN** key.

To change a parameter:

- press and release the **SET** key.
  - press and release the **UP** or **DOWN** key within 15 sec.
  - press and release the **SET** key or do not operate for 15 sec.
- To exit the procedure:
- hold down the **UP** and **DOWN** keys for 4 sec and do not operate for 60 sec (any changes will be saved).

**After changing the parameters, suspend power supply flow to the instrument.**

**5.4 Restoring the Manufacturer's Settings**

To begin the procedure:

- make sure that no other procedure is in progress.
- hold down the **UP** and **DOWN** key for 4 sec: the display will show "PA"
- press and release the **SET** key
- press and release the **UP** or **DOWN** key within 15 sec to set "149"
- press and release the **SET** key or do not operate for 15 sec
- hold down the **UP** and **DOWN** keys for 4 sec: the display will show "dEF"
- press and release the **SET** key
- press and release the **UP** or **DOWN** key within 15 sec to set "1"
- press and release the **SET** key or do not operate for 15 sec: the display will show "dEF" flashing for 4 sec, after which the instrument will exit the procedure.
- suspend the power supply to the instrument.

To exit the procedure before the operation is complete:

- hold down the **UP** and **DOWN** keys for 4 sec during the procedure (that is, before setting "1": the settings will not be restored).

**Make sure that the manufacturer's settings are appropriate (see chapter 12).**

**6 HACCP FUNCTION**

**6.1 Preliminary notes**

EVX201, EVX203, EVX204, EVX205 and EVX215:  
The instrument is able to store up to 3 HACCP alarms.  
The instrument provides the following information:

- the critical value
- the alarm duration (from 1 min to 99 hours and 59 min, partial if the alarm is in progress).

CODE	ALARM TYPE (CRITICAL VALUE)
AL	minimum temperature alarm (the minimum cell temperature during any alarm of this type)
AH	maximum temperature alarm (the maximum cell temperature during any alarm of this type)
id	door microswitch input alarm (the maximum cell temperature during any alarm of this type; see also parameter i4)

- Important Notes:**
- the codes are displayed in the order shown in the table
  - the instrument stores the minimum and maximum temperature alarms provided the temperature associated with the alarm is that of the cell (parameter A0 = 0)
  - the instrument updates the information regarding the alarm provided the critical value of the new alarm is more critical than that stored alarm or provided the information has already been displayed.
  - if the instrument is switched off, no alarms will be stored.

When the problem that caused the alarm disappears, the display is restored to normal operation.

The HACCP LED provides information regarding the HACCP alarm storage status; see paragraph 8.1.

For EVX214 and EVX215:

The instrument is able to store up to 9 HACCP alarms, after which the most recent alarm will substitute the oldest.

- The instrument provides the following information:
- critical value
  - the date and time the alarm was signaled
  - the duration of the alarm (from 1 min to 99 hours and 59 min, partial if the alarm is in progress).

CODE	ALARM TYPE (CRITICAL VALUE)
AL	minimum temperature alarm (the minimum temperature of the cell during the alarm)
AH	maximum temperature alarm (the maximum temperature of the cell during the alarm)
id	door microswitch input alarm (the maximum temperature of the cell during the alarm); see also parameter i4
PF	power supply interruption alarm (cell temperature when power is restored); see also parameters A10 and A12

- Notes:**
- the instrument stores the minimum and maximum temperature alarm provided the temperature associated with the alarm is that of the cell (parameter A0 = 0)
  - to avoid repeatedly storing alarms due to interruptions in the power supply, disconnect the power when the instrument is switched off
  - if the duration of the power supply interruption alarm is long enough to cause a clock error (code "rtc"), the instrument will not provide any information about the alarm duration
  - if the instrument is switched off no alarms will be stored
- When the problem that caused the alarm disappears, the display is restored to normal operation, with the exception of the power supply interruption alarm (code "PF") which requires manual restoration of the normal display.

To manually restore the normal display:

- press a key.

If parameter u1 and/or parameter u11 is set to 3, pressing the key will deactivate the alarm output.

The HACCP LED provides information regarding the storage status of the alarms; see paragraph 8.1.

### 6.2 Display of HACCP alarm information

For EVX201, EVX203, EVX204, EVX205 and EVX215:

To start the procedure:

- ensure that the keyboard is not locked and that no other procedure is in progress
- hold down the **DOWN** key for 1 sec: the display will show the first label available
- press and release the **UP** or **DOWN** key to select **"LS"**
- press and release the **SET** key: the display will show one of the codes included in the table in paragraph 6.1.

To select an alarm:

- press and release the **UP** or **DOWN** key (to select, for example, **"AH"**). To view the information about the alarm:

- press and release the **SET** key: the HACCP LED will stop flashing and remain permanently on and the display will show the following sequence of information (for example):

INFO.	MEANING
<b>8.0</b>	the critical value is 8.0 °C/8 °F
<b>dur</b>	the display is about to show the duration of the alarm
<b>h01</b>	the alarm has been going off for 1 hour (data continues ...)
<b>n15</b>	the alarm lasted for 1 hour and 15 min
<b>AH</b>	the alarm selected

The display shows each message for 1 sec.

To exit the sequence of information:

- press and release the **ON/STAND-BY** key: the display will show the alarm selected (in the example **"AH"**).

To start the procedure:

- exit the sequence of information
- press and release the **UP** or **DOWN** key until the display shows the cell temperature and then do not operate for 60 sec.

Alternatively:

- exit the sequence of information.
- press and release the **ON/STAND-BY** key.

If the instrument does not have any alarms stored, the label **"LS"** will not be displayed.

For EVX214 and EVX215:

To start the procedure:

- ensure that the keyboard is not locked and that no other operation is in progress
- hold down the **DOWN** key for 1 sec: the display will show the first label available
- press and release the **UP** or **DOWN** key to select **"LS"**
- press and release the **SET** key: the display will show the most recent alarm code (or rather, one of the codes shown in the table in paragraph 6.1) followed by the number **"1"**; the larger the number is that follows the alarm code, the older the alarm is).

To select an alarm:

- press and release the **UP** or **DOWN** key (to select, for example, **"AH3"**).

To see information regarding the alarm:

- press and release the **SET** key: the HACCP LED will stop flashing and will remain permanently on and the display will show the following sequence of information (for example):

INFO.	MEANING
<b>8.0</b>	the critical value is 8.0 °C/8 °F
<b>StA</b>	the display is about to show the date and hour in which the alarm was signaled
<b>y09</b>	the alarm was signaled in 2009 (data continues ...)
<b>n03</b>	the alarm was signaled in March (data continues ...)
<b>d26</b>	the alarm was signaled on the 26th of March 2009
<b>h16</b>	the alarm was signaled at 16:00 (other data continues)
<b>n30</b>	the alarm was signaled at 16:30
<b>dur</b>	the display is about to show the alarm duration
<b>h01</b>	the alarm lasted for 1 hour (other data continues)
<b>n15</b>	the alarm lasted 1 hour and 15 min
<b>AH3</b>	the alarm selected

The display will show each message for 1 sec.

To exit the information sequence:

- press and release the **ON/STAND-BY** key: the display will show the selected alarm (**"AH3"** in the example).

To exit the procedure:

- exit the information sequence
- press and release the **UP** or **DOWN** key until the display shows the cell temperature or do not operate for 60 sec.

Alternatively:

- exit the information sequence
- press and release the **ON/STAND-BY** key.

If the instrument does not have any alarms stored, the label **"LS"** will not be displayed.

### 6.3 Cancelling the HACCP alarm list

- ensure that the keyboard is not locked and that no other operation is in progress
- hold down the **DOWN** key for 1 sec: the display will show the first available label
- press and release the **UP** or **DOWN** key to select **"rLS"**
- press and release the **SET** key
- press and release the **UP** or **DOWN** key within 15 sec to set **"149"**

- press and release the **SET** key or do not operate for 15 sec: the display will show a flashing **"- - -"** for 4 sec and the HACCP LED will switch off and then the instrument will exit the procedure.

If the instrument does not have any alarms stored, the label **"rLS"** will not be displayed.

## 7 CALCULATING COMPRESSOR OPERATION HOURS (but EVX201)

### 7.1 Preliminary notes

The instrument is able to store up to 9,999 hours of compressor operation, after which the number **"9999"** starts flashing.

### 7.2 Display of Compressor Operation Hours

- Make sure that the keyboard is not locked and that no other operation is in progress
- press and hold down the **DOWN** key for 1 sec: the display will show the first available label
- press and release the **UP** or down **DOWN** key to select **"CH"**
- press and release the **SET** key.

To exit the procedure:

- press and release the **SET** key or do not operate for 60 sec
- press and release the **UP** or down **DOWN** key until the display shows the cell temperature or do not operate for 60 sec.

Alternatively:





- press and release the **ON/STAND-BY** key.

### 7.3 Cancelling Compressor Operation Hours

- Make sure that the keyboard is not locked and that no other procedure is in progress
- press and hold down the **DOWN** key for 1 sec: the display will show the first available label
- press and release the **UP** or **DOWN** key to select **"rCH"**
- press and release the **SET** key
- press and release the **UP** or **DOWN** key within 15 sec to set **"149"**
- press and release the **SET** key or do not operate for 15 sec: the display will show a flashing **"- - -"** for 4 sec then the instrument will exit the procedure.









## 8 WARNING LIGHTS AND DIRECTIONS

### 8.1 Warning lights

LED	MEANING
	compressor LED light if the LED is on, then the compressor is on if the LED is flashing: <ul style="list-style-type: none"> <li>the working setpoint is in the process of being changed (via the procedure described in paragraph 5.2)</li> <li>compressor protection operation in progress: - parameters C0, C1, C2 - parameter i7 (EVX204, EVX214, EVX205 and EVX215 only)</li> </ul>
	Defrost LED If it is on: <ul style="list-style-type: none"> <li>defrosting is in progress</li> </ul> if it is flashing: <ul style="list-style-type: none"> <li>predripping in progress: - parameter d16 (but EVX201)</li> <li>defrosting required but a compressor protection operation is in progress: - parameters C0, C1 and C2 (but EVX201)</li> <li>dripping in progress: - parameter d7 (but EVX201)</li> <li>heating of coolant liquid in progress: - parameter d15 (but EVX201)</li> </ul>
	Evaporator fan LED light If it is on, the evaporator fan is on (but EVX201) If it is flashing, the evaporator fan is deactivated - parameter F3 (but EVX201)
	Cell light LED If it is on, the cell light has been switched on manually (EVX204, EVX214, EVX205 and EVX215 only and provided that parameter u1 and/or parameter u11 is set to 0) if it is flashing, the cell light has been switched on by remote: - parameter i0 (EVX204, EVX214, EVX205 and EVX215 only and provided that parameter u1 and/or parameter u11 is set to 0)
	Multifunction LED light If it is on: <ul style="list-style-type: none"> <li>the demisting resistors are switched on (EVX204, EVX214, EVX205 and EVX215 only and provided that parameter u1 and/or parameter u11 is set to 1)</li> <li>the auxiliary output has been manually switched on (EVX204, EVX214, EVX205 and EVX215 only and provided that parameter u1 and/or parameter u11 is set to 2)</li> <li>the door resistors will be switched on (EVX204, EVX214, EVX205 and EVX215 only and provided that parameter u1 and/or parameter u11 is set to 4)</li> <li>the evaporator valve will be switched on (EVX204, EVX214, EVX205 and EVX215 only and provided that parameter u1 and/or parameter u11 is set to 5)</li> <li>the condenser fan will be switched on (EVX204, EVX214, EVX205 and EVX215 only and provided that parameter u1 and/or parameter u11 is set to 6)</li> </ul>

if it is flashing:

- the auxiliary output has been switched on remotely:  
- parameter i5 (EVX204, EVX214, EVX205 and EVX215 only and provided that parameter u1 and/or parameter u11 is set to 2)
- a delay in switching off the condenser fan is in progress:  
- parameter F12 (EVX204, EVX214, EVX205 and EVX215 only and provided that parameter u1 and/or parameter u11 is set to 6)

	Clock LED if flashing, the day and real time are in the process of being changed (EVX214 and EVX215 only)
<b>HACCP</b>	HACCP LED if it is on, all information regarding HACCP alarms has not been displayed if it is flashing, the instrument has stored at least one new HACCP alarm if it is off, all information regarding the HACCP alarms has been displayed or the list of HACCP alarms has been cancelled
	Energy Saving LED if it is on, the Energy Saving function is running (but EVX201) - parameters r4, F13, F14, i5, i10, HE1 and HE2
	maintenance LED if on, compressor maintenance is required (but EVX201): - parameter C10
	Overcooling LED if on, the Overcooling function is on progress - parameters r5 and r6
	Alarms LED if on, an alarm or error is in progress
	Celsius grade LED if on, the temperatures will be displayed using the Celsius grade unit of measurement: - parameter P2
	Fahrenheit grade LED if on, the temperatures will be displayed using the Fahrenheit grade unit of measurement: - parameter P2
	on/stand-by LED if on, the instrument is in stand-by mode
<b>8.2 Signal Descriptions/Explanations</b>	
<b>CODE</b>	<b>MEANING</b>
<b>rhL</b>	operation for a low percentage of relative humidity in progress
<b>rhH</b>	operation for a high percentage of relative humidity in progress
<b>Loc</b>	the keyboard is locked: - see paragraph 4.13 the working setpoint is blocked: - parameter r3
<b>- - -</b>	the operation requested is not available
<b>9 ALARMS</b>	
<b>9.1 Alarms</b>	
<b>CODE</b>	<b>MEANING</b>
<b>AL</b>	Minimum alarm temperatures ( <b>HACCP alarms</b> ) Solutions: <ul style="list-style-type: none"> <li>check the cell temperature (EVX201 only)</li> <li>check the temperature associated with the alarm (but EVX201)</li> <li>refer to: - parameters A1 and A2 (EVX201 only) - see parameters A0, A1 and A2 (but EVX201)</li> </ul> Main consequences: <ul style="list-style-type: none"> <li>the instrument will store the alarm (EVX201 only)</li> <li>if parameter A0 is set to 0, the instrument will store the alarm (but EVX201)</li> <li>the alarm output will be activated (provided that parameter u1 and/or parameter u11 is set to 3)</li> </ul>
<b>AH</b>	Maximum temperature alarm ( <b>HACCP alarms</b> ) Solutions: <ul style="list-style-type: none"> <li>check the cell temperature</li> <li>refer to: - parameters A4 and A5</li> </ul> Main consequences: <ul style="list-style-type: none"> <li>the instrument will store the alarm</li> <li>the alarm output will be activated (provided that parameter u1 and/or parameter u11 is set to 3)</li> </ul>
<b>id</b>	Door microswitch input alarm ( <b>HACCP alarms</b> ) Solutions: <ul style="list-style-type: none"> <li>verify the cause of the input activation</li> <li>see parameters i0, i1 and i4</li> </ul> Main consequences: <ul style="list-style-type: none"> <li>the effect established with parameter i0</li> <li>if parameter i0 is set to 1, the instrument will store the alarm, provided parameter i2 is not set to -1</li> <li>the alarm output will be activated (provided that parameter u1 and/or parameter u11 is set to 3)</li> </ul>
<b>PF</b>	Power supply interruption alarm ( <b>HACCP alarms</b> : only EVX214 and EVX215) Solutions: <ul style="list-style-type: none"> <li>verify the cause of the interruption in power supply</li> <li>parameters A10 and A12 are seen</li> </ul>

	<ul style="list-style-type: none"> <li>press a key to restore normal display</li> </ul> <p>Main consequences:</p> <ul style="list-style-type: none"> <li>if the power supply interruption lasts longer than the time established with parameter A10, the instrument will store the alarm</li> <li>the alarm output will be activated (provided that parameter u1 and/or parameter u11 is set to 3)</li> </ul>
<b>iA</b>	<p>Multifunction input alarm (only EVX204, EVX214, EVX205 and EVX215)</p> <p>Solutions:</p> <ul style="list-style-type: none"> <li>verify the cause of input activation</li> <li>parameters i5 and i6 are seen</li> </ul> <p>Main consequences:</p> <ul style="list-style-type: none"> <li>the effect established with parameter i5</li> <li>the alarm output will be activated (provided that parameter u1 and/or parameter u11 is set to 3)</li> </ul>
<b>iSd</b>	<p>Pressure switch alarm (only EVX204, EVX214, EVX205 and EVX215)</p> <p>Solutions:</p> <ul style="list-style-type: none"> <li>verify the cause of input activation</li> <li>parameters i5, i6, i7, i8 and i9 are seen</li> <li>switch off and re-start the instrument or suspend the power supply</li> </ul> <p>Main consequences:</p> <ul style="list-style-type: none"> <li>the regulators will switch off</li> <li>the alarm output will be activated (provided that parameter u1 and/or parameter u11 is set to 3)</li> </ul>
<b>COH</b>	<p>Condenser overheated alarm (only EVX204, EVX214, EVX205 and EVX215)</p> <p>Solutions:</p> <ul style="list-style-type: none"> <li>check the temperature of the condenser</li> <li>parameter C6 is seen</li> </ul> <p>Main consequences:</p> <ul style="list-style-type: none"> <li>the alarm output will be activated (provided that parameter u1 and/or parameter u11 is set to 3)</li> <li>if parameter u1 and/or parameter u11 is set to 6, the condenser fan will be switched on</li> </ul>
<b>CsD</b>	<p>Compressor blocked alarm (only EVX204, EVX214, EVX205 and EVX215)</p> <p>Solutions:</p> <ul style="list-style-type: none"> <li>check the condenser temperature</li> <li>parameter C7 seen</li> <li>switch off and re-start the instrument: if when the instrument is switched back on, the temperature of the condenser is still higher than that established in parameter C7, disconnect the power supply and clean the condenser</li> </ul> <p>Main consequences:</p> <ul style="list-style-type: none"> <li>the compressor and the evaporator fan will be switched off</li> <li>the alarm output will be activated (provided that parameter u1 and/or parameter u11 is set to 3)</li> </ul>
<b>dFd</b>	<p>Defrosting alarm switched off because maximum time has been reached (but EVX201)</p> <p>Solutions:</p> <ul style="list-style-type: none"> <li>verify that the evaporator probe is intact</li> <li>see parameters d2, d3 and d11</li> <li>press a key to restore normal display</li> </ul> <p>Main consequences:</p> <ul style="list-style-type: none"> <li>the instrument will continue to function normally</li> </ul>

When the problem that caused the alarm disappears, the instrument returns to normal function, with the exception of the following alarms:

- the power supply interruption alarm (code "PF") which requires the pressing of a key
- pressure switch alarm (code "iSd") which requires the switching off of the instrument or the temporary suspension of the power supply
- compressor blocked by condenser temperature alarm (code "CsD") which requires the switching off of the instrument or the temporary suspension of the power supply
- Defrosting alarm switched off because maximum time has been reached (code "dFd") which requires the pressing of a key.

## 10 ERRORS

### 10.1 Errors

CODE	MEANING
<b>Pr1</b>	<p>Cell probe error</p> <p>Solutions:</p> <ul style="list-style-type: none"> <li>verify that the probe is a type NTC</li> <li>verify that the probe is intact</li> <li>verify the instrument-probe connection</li> <li>check the cell temperature</li> </ul> <p>Main consequences:</p> <ul style="list-style-type: none"> <li>compressor activity will depend on parameters C4 and C5</li> <li>the defroster will not be activated</li> <li>the alarm output will be activated (provided that parameter u1 and/or parameter u11 is set to 3)</li> <li>the door resistors will be switched off (EVX204, EVX214, EVX205 and EVX215 only and provided parameter u1 and/or parameter u11 is set to 4)</li> <li>the evaporator valve will be disconnected (EVX204, EVX214, EVX205 and EVX215 only and provided parameter u1 and/or parameter u11 is set to 5)</li> </ul>

<b>Pr2</b>	<p>Evaporator probe error (but EVX201)</p> <p>Solutions:</p> <ul style="list-style-type: none"> <li>the same as the preceding case but with respect to the evaporator probe</li> </ul> <p>Main consequences:</p> <ul style="list-style-type: none"> <li>if parameter P3 is set to 1, the defrosting period will last for the amount of time set with parameter 3</li> <li>if parameter P3 is set to 1 and parameter d8 is set to 2 or to 3, the instrument will operate as if parameter d8 were set to 0</li> <li>if parameter F0 is set to 3 or 4, the instrument will operate as if the parameter were set to 2</li> <li>the alarm output will be activated (provided that parameter u1 and/or parameter u11 is set to 3)</li> </ul>
<b>Pr3</b>	<p>Condenser probe error (EVX204, EVX214, EVX205 and EVX215 only)</p> <p>Solutions:</p> <ul style="list-style-type: none"> <li>the same as the preceding case but with respect to the condenser probe</li> </ul> <p>Main consequences:</p> <ul style="list-style-type: none"> <li>condenser overheated alarm (code "COH") will not be activated</li> <li>compressor blocked by condenser temperature alarm (code "CsD") will never be activated</li> <li>the alarm output will be activated (provided that parameter u1 and/or parameter u11 is set to 3)</li> <li>if parameter u1 and/or parameter u11 is set to 6, the condenser fan will operate in parallel with the condenser</li> </ul>
<b>rtc</b>	<p>Clock error (EVX214 and EVX215 only)</p> <p>Solutions:</p> <ul style="list-style-type: none"> <li>re-set the day and real time</li> </ul> <p>Main consequences:</p> <ul style="list-style-type: none"> <li>if parameter d8 is set to 4, the instrument will operate as if the parameter were set to 0</li> <li>the HACCP function will not provide information regarding the date and hour in which the alarm was signaled</li> <li>the Energy Saving function will not be available in real time</li> <li>the alarm output will be activated (provided that parameter u1 and/or parameter u11 is set to 3)</li> </ul>

When the problem that caused the alarm disappears, the instrument returns to normal operation, with the exception of the clock error (code "rtc") which requires that the date and hour be set.

## 11 TECHNICAL DATA

### 11.1 Technical data

Case: without cover.

Frontal protection grade: IP 00.

Connections: 6.3 mm faston connectors (0.248 in, power and outputs), screw terminal board (inputs), 6-outlet connector (serial port).

Operating temperature: from 0 to 55 °C (from 32 to 131 °F, 10 ... 90% relative humidity without condensaton).

Power: 230 VCA, 50/60 Hz or 115 VCA, 50/60 Hz.

Preservation of clock data in the absence of power (EVX214 and EVX215 only): 24 hr fully-charged battery.

Battery recharge time (EVX214 and EVX215 only): 2 min without interruption (the battery is recharged by the instrument's power supply).

Alarm buzzers: upon request in EVX201 and EVX203; built-in for EVX204, EVX214, EVX205 and EVX215).

EVX201 measure inputs: 1 (cell probe) for NTC probe.

EVX203 measure inputs: 2 (cell probe and evaporator probe) for the NTC probe.

EVX204, EVX214, EVX205 and EVX215 measure inputs: 3 (cell probe, evaporator probe and condenser probe) for NTC probe.

EVX201 and EVX203 digital inputs: 1 (door microswitch) for normally open /normally closed contact (free contact, 5 V 1 mA).

EVX204, EVX214, EVX205 and EVX215 digital inputs: 2 (door microswitch and multifunction) for normally open/normally closed contact (free contact, 5 V 1 mA).

Measurement field: from -40 to 105 °C (from -40 to 220 °F).

Resolution: 0.1 °C/1 °C/1 °F.

EVX201 digital outputs: 1 relay:

- compressor relay: 16 A res. @ 250 VCA (normally open contact); 30 A res. @ 250 VCA upon request.

The maximum load current allowed is 16 A.

EVX203 digital outputs: 3 relays:

- compressor relay: 16 A res. @ 250 VCA (normally open contact); 30 A res. @ 250 VCA upon request
- defrosting relay: 8 A res. @ 250 VCA (exchange contact)
- evaporator fan relay: 8 A res. @ 250 VCA (normally open contact).

The maximum load current allowed is 16 A.

EVX204 and EVX214 digital outputs: 4 relays:

- compressor relay: 30 A res. @ 250 VCA (normally open contact)
- defrosting relay: 8 A res. @ 250 VCA (exchange contact)
- evaporator fan relay: 8 A res. @ 250 VCA (normally open contact)
- fourth output relay: from 8 A res. @ 250 VCA (normally open contact).

The maximum load current allowed is 16 A.

EVX205 and EVX215 digital outputs: 5 relays:

- compressor relay: 30 A res. @ 250 VCA (normally open contact)
- defrosting relay: 8 A res. @ 250 VCA (exchange contact)
- evaporator fan relay: 8 A res. @ 250 VCA (normally open contact)
- fourth output relay: from 8 A res. @ 250 VCA (normally open contact)
- fifth output relay: from 5 A res. @ 250 VCA (normally open contact).

The maximum load current allowed is 16 A.

Serial port: port for communicating with the monitoring system (via serial interface, via TTL with a MODBUS communications protocol) or via programming key.

**12 WORKING SETPOINT AND CONFIGURATION PARAMETERS**

**12.1 Working setpoint**

	MIN.	MAX.	UM	EVX201	EVX203	EVX204/5	EVX214/5	WORKING SETPOINT
r1	r2		°C/°F (1)	2.0	-2.0	-18.0	-18.0	working setpoint; see also r0

**12.2 Configuration parameters**

PAR.	MIN.	MAX.	UM	EVX201	EVX203	EVX204/5	EVX214/5	WORKING SETPOINT
SP	r1	r2	°C/°F (1)	2.0	-2.0	-18.0	-18.0	working setpoint; see also r0
PAR.	MIN.	MAX.	UM	EVX201	EVX203	EVX204/5	EVX214/5	MEASUREMENT INPUTS
CA1	-25.0	25.0	°C/°F (1)	0.0	0.0	0.0	0.0	offset cell probe
CA2	-25.0	25.0	°C/°F (1)	not avail.	0.0	0.0	0.0	offset evaporator probe
CA3	-25.0	25.0	°C/°F (1)	not avail.	not avail.	0.0	0.0	offset condenser probe
P1	0	1	----	1	1	1	1	Celsius degree decimal point (for size displayed during normal operation) 1 = YES
P2	0	1	----	0	0	0	0	temperature unit of measurement (2) 0 = °C 1 = °F
P3	0	2	----	not avail.	1	1	1	evaporator probe function 0 = probe absent 1 = defrosting probe and probe for evaporator fan thermostatisation 2 = probe for evaporator fan thermostatisation
P4	0	1	----	not avail.	not avail.	1	1	enabling of condenser probe 1 = YES
P8	0	250	ds	5	5	5	5	delay in display of variations in temperature detected by the probes
PAR.	MIN.	MAX.	UM	EVX201	EVX203	EVX204/5	EVX214/5	MAIN REGULATOR
r0	0.1	15.0	°C/°F (1)	2.0	2.0	2.0	2.0	working setpoint differential
r1	-99.0	r2	°C/°F (1)	-50.0	-50.0	-50.0	-50.0	minimum working setpoint
r2	r1	99.0	°C/°F (1)	50.0	50.0	50.0	50.0	maximum working setpoint
r3	0	1	----	0	0	0	0	locking of working setpoint calibration (using the procedure described in paragraph 5.2) 1 = YES
r4	0.0	99.0	°C/°F (1)	not avail.	not avail.	0.0	0.0	increase in temperature during Energy Saving function; see also i5, i10, HE1 and HE2
r5	0.0	99.0	°C/°F (1)	0.0	0.0	0.0	0.0	decrease in temperature during Overcooling function; see also r6
r6	0	240	min	30	30	30	30	duration of Overcooling function; see also r5
r7	0.0	99.0	°C/°F (1)	not avail.	10.0	10.0	10.0	minimum difference "cell temperature - working setpoint" (when the instrument switches on) such as to provoke the exclusion of the consequent value of the evaporator temperature among the ones used for the calculation of the relative average (for the defrost activation; only if d8 = 3); also look at d17 (3)
PAR.	MIN.	MAX.	UM	EVX201	EVX203	EVX204/5	EVX214/5	COMPRESSOR PROTECTION SYSTEM
C0	0	240	min	0	0	0	0	delay in switching on of compressor after the instrument switches on (3) minimum time between two consecutive compressor start-ups;
C1	0	240	min	5	5	5	5	also delay in compressor start-up after conclusion of cell probe error (code "Pr1") (4) (5)
C2	0	240	min	3	3	3	3	minimum duration of compressor switch off time (4)
C3	0	240	sec	0	0	0	0	minimum duration of compressor switch on time
C4	0	240	min	10	10	10	10	duration of compressor switch off during cell probe error (code "Pr1"); see also C5
C5	0	240	min	10	10	10	10	duration of compressor switch on during cell probe error (code "Pr1"); see also C4
C6	0.0	199.0	°C/°F (1)	not avail.	not avail.	80.0	80.0	condenser temperature is higher than that at which the condenser overheating alarm is activated (code "COH") (6)
C7	0.0	199.0	°C/°F (1)	not avail.	not avail.	90.0	90.0	condenser temperature is higher than the limit at which the compressor blocked alarm is activated (code "Csd")
C8	0	15	min	not avail.	not avail.	1	1	compressor alarm delay locked (code "Csd") (7)
C10	0	9.999	hr	not avail.	0	0	0	number of operating hours is higher than the limit at which the need for maintenance is signaled. 0 = function absent
PAR.	MIN.	MAX.	UM	EVX201	EVX203	EVX204/5	EVX214/5	DEFROSTING
d0	0	99	hr	8	8	8	8	if d8 = 0, 1 or 2, defrosting interval (8) 0 = interval defrosting will never be activated if d8 = 3, maximum defrost interval
d1	0	2	----	not avail.	0	0	0	type of defrosting 0 = ELECTRIC - during defrosting the compressor will remain off and the defrosting output will be activated; evaporator fan activity will depend on parameter F2 1 = BY HOT GAS - during defrosting the compressor will be switched on and the defrosting output will be activated; evaporator fan activity will depend on parameter F2 2 = VIA STOPPING OF COMPRESSOR - during defrosting the compressor will remain switched off and the defrosting output will remain deactivated; evaporator fan activity will depend on parameter F2
d2	-99.0	99.0	°C/°F (1)	not avail.	2.0	2.0	2.0	temperature at end of defrosting (only if P3 = 1); see also d3
d3	0	99	min	30	30	30	30	se P3 = 0 or 2, defrosting duration se P3 = 1, maximum defrosting duration; see also d2 0 = defrosting will not be activated
d4	0	1	----	0	0	0	0	defrosting when instrument is switched on (only if d8 = 0, 1, 2 or 3) (3) 1 = YES
d5	0	99	min	0	0	0	0	if d4 = 0, minimum time between switching on of instrument and activation of defrosting; see also i5 (3) if d4 = 1, delay in activation of defrosting after instrument is switched on; see also i5 (3)
d6	0	1	----	1	1	1	1	temperature displayed during defrosting 0 = cell temperature 1 = if at the time of defrosting activation, the cell temperature is lower than the "working setpoint + r0", at most "working setpoint + r0"; if at the time of defrosting activation, the cell temperature is higher than the "working setpoint + r0", at most the cell temperature when defrosting is activated
d7	0	15	min	not avail.	2	2	2	dripping duration (during dripping the compressor will remain switched off and the defrosting output will remain deactivated; if d16 = 0, evaporator fan activity will depend on parameter F2; if d16 ≠ 0, the evaporator fan will remain switched off)
d8	0	4	----	0	0	0	0	defrosting activation methods 0 = AT INTERVALS - defrosting will be activated once the instrument has altogether been running for time d0 1 = AT INTERVALS - defrosting will be activated once the compressor has altogether been switched on for time d0 2 = AT INTERVALS - defrosting will be activated once the evaporator temperature has altogether been below temperature d9 for time d0 (visible in EVX203, EVX204, EVX214, EVX205 and EVX215 only) (10) 3 = ADAPTABLE - defrosting will be activated when one of the following conditions is present (visible in EVX203, EVX204, EVX214, EVX205 and EVX215 only; also look at d0) (10): - condition 1: the evaporator temperature will be below temperature d22 and the compressor will altogether be switched on for time d18 - condition 2: the evaporator temperature will fall below temperature d19 4 = IN REAL TIME - defrosting will be activated at the times established in parameters Hd1 ... Hd6 (visible in EVX214 and EVX215 only)
d9	-99.0	99.0	°C/°F (1)	not avail.	0.0	0.0	0.0	evaporator temperature is higher than that at which the defrost interval counter is suspended (only if d8 = 2)
d11	0	1	----	not avail.	0	0	0	defrosting alarm switches off once maximum time limit has been reached (code "dFd"); only if P3 = 1 and in absence of an evaporator probe (code "Pr2") 1 = YES
d15	0	99	min	not avail.	0	0	0	minimum time that the compressor must be switched on before defrosting can be activated (only if d1 = 1) (11)
d16	0	99	min	not avail.	0	0	0	predripping duration (during predripping the compressor will remain switched off, the defrosting output will be activated and the evaporator fan will remain switched off)

d17	1	10	----	not avail.	1	1	1	number of evaporator temperature values used for the calculation of the relative average (for the defrost activation; only if d8 = 3); also look at r7, i11 and i12
d18	0	3,000	min	not avail.	40	40	40	defrosting interval (only if d8 = 3 and for condition 1) 0 = defrosting for condition 1 will never be activated
d19	0.0	40.0	°C/°F (1)	not avail.	3.0	3.0	3.0	evaporator temperature above which the defrost is activated (relative to the evaporator temperatures average, or "evaporator temperatures average - d19") (only if d8 = 3 and for condition 2); also look at d17
d20	0	500	min	not avail.	180	180	180	minimum consecutive time the compressor must be switched on such as to provoke the defrost activation 0 = the defrost will never be activated because the compressor has been switched on
d21	0	500	min	not avail.	200	200	200	minimum consecutive time the compressor must be switched on after the insturment switches on (on condition that the difference "cell temperature - working setpoint" is higher temperature r7) and after function Overcooling is activated such as to provoke the defrost activation 0 = the defrost will never be activated because the compressor has been switched on
d22	0.0	10.0	°C/°F (1)	not avail.	2.0	2.0	2.0	evaporator temperature above which the defrosting interval is suspended (relative to the evaporator temperatures average, or "evaporator temperatures average + d22") (only if d8 = 3 and for condition 1); also look at d17
d23	0.0	10.0	°C/°F (1)	not avail.	1.0	1.0	1.0	evaporator temperatures average increase during function Energy Saving (for defrost activation; only if d8 = 3); also look at d17
PAR.	MIN.	MAX.	UM	EVX201	EVX203	EVX204/5	EVX214/5	TEMPERATURE ALARMS
A0	0	1	----	not avail.	0	0	0	temperature associated with the minimum temperature alarm (code "AL") 0 = cell temperature 1 = evaporator temperature (12)
A1	-99.0	99.0	°C/°F (1)	-10.0	-10.0	-10.0	-10.0	temperature below that at which the minimum temperature alarm is activated (code "AL"); see also A0, A2 and A11
A2	0	2	----	1	1	1	1	type of minimum temperature alarm (code "AL") 0 = alarm absent 1 = relative to working setpoint (that is "working setpoint - A1"; consider A1 without sign) 2 = absolute (that is A1)
A4	-99.0	99.0	°C/°F (1)	10.0	10.0	10.0	10.0	temperature higher than that at which the maximum temperature alarm is activated (code "AH"); see also A5 and A11
A5	0	2	----	1	1	1	1	type of maximum temperature alarm (code "AH") 0 = alarm absent 1 = relative to working setpoint (that is "working setpoint + A4"; consider A1 without sign)) 2 = absolute (that is A4)
A6	0	240	min	120	120	120	120	delay in maximum temperature alarm (code "AH") after the instrument is switched on (3)
A7	0	240	min	15	15	15	15	temperature alarm delay (code "AL" and code "AH")
A8	0	240	min	15	15	15	15	delay in maximum temperature alarm (code "AH") following the conclusion of defrosting (in EVX201 only) and following the conclusion of evaporator fan (in EVX203, EVX204, EVX214, EVX205 and EVX215 only) (13)
A9	0	240	min	15	15	15	15	delay in maximum temperature alarm (code "AH") following the disactivation of the door microswitch input (14)
A10	0	240	min	not avail.	not avail.	not avail.	1	duration of interruption in the power supply that occurs when the instrument has been running for long enough to cause the storage of the power interruption alarm when the power supply is restored. (code "PF") (15)
A11	0.1	15.0	°C/°F (1)	2.0	2.0	2.0	2.0	differential of parameters A1 and A4
A12	0	2	----	not avail.	not avail.	not avail.	1	kind of signal for power interruption alarm (code "PF"); also look at A10 0 = the alarm will not be signalled 1 = the display will show the code "PF" flashing and the buzzer will be activated 2 = the display will show the code "PF" flashing and the buzzer will be activated (this last on condition that the power interruption duration is higher than time A10)
PAR.	MIN.	MAX.	UM	EVX201	EVX203	EVX204/5	EVX214/5	EVAPORTOR FAN
F0	0	5	----	not avail.	1	1	1	evaporator fan activity during normal operation 0 = switched off 1 = switched on; see also F13, F14 and i10 2 = in parallel with the compressor; see also F9, F13, F14 and i10 3 = dependent on F1 (16) 4 = switched off if the compressor is switched off, dependent on F1 if the compressor is switched on; see also F9 (16) 5 = dependent on F6; see also F9
F1	-99.0	99.0	°C/°F (1)	not avail.	-1.0	-1.0	-1.0	evaporator temperature above the limit at which the evaporator fan is switched off (only if F0 = 3 or 4); see also F8
F2	0	2	----	not avail.	0	0	0	evaporator fan activity during defrosting and dripping 0 = switched off 1 = switched on (setting parameter d7 to 0 is recommended) 2 = dependent on F0
F3	0	15	min	not avail.	2	2	2	maximum duration of evaporator fan disactivation; see also F7 (during evaporator fan desactivation the compressor can be switched on, the defrosting output will remain disactivated and the evaporator fan will remain switched off)
F4	0	240	sec	not avail.	60	60	60	time duration that evaporator fan is switched off during operation for a low percentage of relative humidity when the compressor is switched off; see also F5 (only if F0 = 5)
F5	0	240	sec	not avail.	10	10	10	time duration that evaporator fan is switched on during operation for a low percentage of relative humidity when the compressor is switched off; see also F4 (only if F0 = 5)
F6	0	1	----	not avail.	0	0	0	operation for low or high percentage of relative humidity (only if F0 = 5) (17) 0 = <u>LOW RELATIVE HUMIDITY</u> - the evaporator fan will operate in parallel with the compressor; see also F4 and F5 1 = <u>HIGH RELATIVE HUMIDITY</u> - the evaporator fan will always be switched on
F7	-99.0	99.0	°C/°F (1)	not avail.	5.0	5.0	5.0	evaporator temperature below limit at which the evaporator fan is disactivated (relative to working setpoint, that is "working setpoint + F7"); see also F3
F8	0.1	15.0	°C/°F (1)	not avail.	2.0	2.0	2.0	parameter F1 differential
F9	0	240	sec	not avail.	not avail.	0	0	delay in the switching off of evaporator fan following the switching off of the compressor (only if F0 = 2, 4 and 5)
F11	0.0	99.0	°C/°F (1)	not avail.	not avail.	15.0	15.0	condenser temperature above that at which the condenser fan is switched on ("F11 + 2.0 °C/4 °F, only if u1 and/or u11 = 6 and provided the compressor is switched on); see also F12 (18)
F12	0	240	sec	not avail.	not avail.	30	30	delay in switching off of the condenser fan following the switching off of the condenser (only if u1 and/or u11 = 6); see also F11
F13	0	240	min	not avail.	5	5	5	time the evaporator fan remains turned off during function Energy Saving; see also F14 and i10 (only if F0 = 1 or 2)
F14	0	240	min	not avail.	5	5	5	time the evaporator fan remains turned on during function Energy Saving; see also F13 and i10 (only if F0 = 1 or 2)
PAR.	MIN.	MAX.	UM	EVX201	EVX203	EVX204/5	EVX214/5	DIGITAL INPUTS
i0	0	5	----	1	2	3	3	effect caused by the activation of the door microswitch input; see also i4 0 = no effect 1 = the compressor and evaporator fan (evaporator fan in EVX203, EVX204, EVX214, EVX205 and EVX215 only) will be switched off (at most for time i3 or until the input is disactivated) (19) 2 = the evaporator fan will be switched off (at most for time i3 or until the input is disactivated) (visible in EVX203, EVX204, EVX214, EVX205 and EVX215 only) 3 = the cell light will be switched on (only if u1 and/or u11 = 0, until the input is disactivated) (only visible in EVX204, EVX214, EVX205 and EVX215) 4 = the compressor and evaporator fan will be switched off (at most for time i3 or until the input is disactivated) and the cell light will be switched on (only if u1 and/or u11 = 0, until the input is disactivated) (only visible in EVX204, EVX214, EVX205 and EVX215) (19) 5 = the evaporator fan will be switched off (at most until time i3 or until the input has been disactivated) and the cell light will be switched on (only if u1 and/or u11 = 0, until the input is disactivated) (only visible in EVX204, EVX214, EVX205 and EVX215)
i1	0	1	----	0	0	0	0	type of door microswitch input contact 0 = normally open (active input with closed contact) 1 = normally closed (active input with open contact)
i2	-1	120	min	30	30	30	30	delay in signaling of door microswitch input alarm (code "id") -1 = the alarm will not be signaled

i3	-1	120	min	15	15	15	15	maximum duration of the effect caused by activation of the door microswitch on the compressor and the evaporator fan (the evaporator fan in EVX203, EVX204, EVX214, EVX205 and EVX215 only) -1 = the effect will last until the input is deactivated
i4	0	1	----	0	0	0	0	storage of door microswitch input alarm (code "i4") (20) 1 = YES
i5	0	6	----	not avail.	not avail.	2	2	effect caused by the activation of the multifunction input 0 = no effect 1 = <u>SYNCHRONISATION OF DEFROSTING PERIODS</u> - once time d5 has passed defrosting will be activated 2 = <u>ACTIVATION OF ENERGY SAVING FUNCTION</u> - the Energy Saving function will be activated (until the input is deactivated), provided the Overcooling function is running; see also r4 3 = <u>ACTIVATION OF MULTIFUNCTION INPUT ALARM</u> - once time i7 has passed the display will show the flashing code "iA" and the buzzer will be activated (until the input is deactivated) 4 = <u>ACTIVATION OF THE PRESSURE SWITCH ALARM</u> - the compressor will be switched off, if u1 and/or u11 = 6 the condenser fan will be switched on, the display will show the flashing code "iA" and the buzzer will be activated (until the input is deactivated); when the input has been activated the number of times established with parameter i8 the regulators will be switched off, if u1 and/or u11 = 6 the condenser fan will be switched on, the display will show the flashing code "iSd" and the buzzer will be activated (until the input is deactivated and the instrument is switched off and re-started or until the power supply is interrupted); see also i7 and i9 5 = <u>SWITCHING ON THE AUXILIARY OUTPUT</u> - the auxiliary output will be switched on (only if u1 and/or u11 = 2, until the input is deactivated) 6 = <u>SWITCHING OFF THE INSTRUMENT</u> - the instrument will be switched off (until the input is deactivated)
i6	0	1	----	not avail.	not avail.	0	0	type of multifunction input contact 0 = normally open (active input with closed contact) 1 = normally closed (active input with open contact)
i7	0	120	min	not avail.	not avail.	0	0	if i5 = 3, multifunction input alarm delay (code "iA") if i5 = 4, delay in compressor switching on after the deactivation of the multifunction input (21)
i8	0	15	----	not avail.	not avail.	0	0	number of multifunction input alarms (code "iA") such as to cause a pressure switch alarm (code "iSd") (if i5 = 4) 0 = alarm absent
i9	1	999	min	not avail.	not avail.	240	240	time that must pass in absence of multifunction output alarms (code "iA") so that the alarm counter is reset (only if i5 = 4)
i10	0	999	min	not avail.	0	0	0	time without activations of the door switch input (on condition that the cabinet temperature has reached the working setpoint) in order that function Energy Saving is activated automatically (it has effect on the evaporator fan only if F0 = 1 or 2) 0 = the function will never automatically be activated
i11	0	240	s	not avail.	15	15	15	minimum time the door switch input must be activated such as to provoke the exclusion of the consequent value of the evaporator temperature among the ones used for the calculation of the relative average (for the defrost activation; only if d8 = 3); also look at d17
i12	0	240	s	not avail.	60	60	60	minimum time the door switch input must be activated altogether such as to provoke the exclusion of the consequent value of the evaporator temperature among the ones used for the calculation of the relative average (for the defrost activation; only if d8 = 3); also look at d17
i13	0	240	----	not avail.	180	180	180	number of door switch input activations such as to provoke the defrost activation 0 = the defrost will never be activated because of the door switch input activation
i14	0	240	min	not avail.	32	32	32	minimum duration of the door switch input activation such as to provoke the defrost activation 0 = the defrost will never be activated because of the door switch input activation
PAR.	MIN.	MAX.	UM	EVX201	EVX203	EVX204/5	EVX214/5	DIGITAL OUTPUTS
u1	0	6	----	not avail.	not avail.	0	0	operation controlled by fourth output (22) 0 = <u>CELL LIGHT</u> - in this case the <b>AUXILIARY</b> key and parameters i0 and u2 will be activated 1 = <u>DEMISTER RESISTORS</u> - in this case the <b>AUXILIARY</b> key and parameter u6 will be activated 2 = <u>AUXILIARY OUTPUT</u> - in this case the <b>AUXILIARY</b> key and parameters i5 and u2 will be activated 3 = <u>ALARM OUTPUTS</u> - in this case parameter u4 will be activated 4 = <u>DOOR RESISTORS</u> - in this case parameter u5 will be activated 5 = <u>EVAPORATOR VALVE</u> - in this case parameters u7 and u8 will be activated 6 = <u>CONDENSER FAN</u> - in this case parameters P4, F11 and F12 will be activated
u2	0	1	----	not avail.	not avail.	0	0	enabling of manual switch on/switch off of the cell light or the auxiliary output when the instrument is switched off (only if u1 and/or u11 = 0 or 2) (23) 1 = YES
u4	0	1	----	not avail.	not avail.	1	1	enabling of alarm output deactivation with the silencing of the buzzer (only if u1 and/or u11 = 3) 1 = YES
u5	-99.0	99.0	°C/°F (1)	not avail.	not avail.	-1.0	-1.0	cell temperature below that at which the door resistors are switched on ("u5 - 2.0 °C/4 °F; only if u1 and/or u11 = 4) (6)
u6	1	120	min	not avail.	not avail.	5	5	operating time of demister resistors (only if u1 and/or u11 = 1)
u7	0.0	99.0	°C/°F (1)	not avail.	not avail.	2.0	2.0	cell temperature below that at which the evaporator valve is deactivated (relating to the working setpoint, that is "working setpoint + u7") (only if u1 and/or u11 = 5) (6)
u8	0	1	----	not avail.	not avail.	0	0	type of evaporator valve contact (only if u1 and/or u11 = 5) 0 = normally open (valve active with contact closed) 1 = normally closed (valve active with contact open)
u9	0	1	----	1	1	1	1	enabling of buzzer 1 = YES
u11	0	6	----	not avail.	not avail.	3	3	operation controlled by fifth output (22) 0 = <u>CELL LIGHT</u> - in this case the <b>AUXILIARY</b> key and parameters i0 and u2 will be activated 1 = <u>DEMISTER RESISTORS</u> - in this case the <b>AUXILIARY</b> key and parameter u6 will be activated 2 = <u>AUXILIARY OUTPUT</u> - in this case the <b>AUXILIARY</b> key and parameters i5 and u2 will be activated 3 = <u>ALARM OUTPUTS</u> - in this case parameter u4 will be activated 4 = <u>DOOR RESISTORS</u> - in this case parameter u5 will be activated 5 = <u>EVAPORATOR VALVE</u> - in this case parameters u7 and u8 will be activated 6 = <u>CONDENSER FAN</u> - in this case parameters P4, F11 and F12 will be activated
PAR.	MIN.	MAX.	UM	EVX201	EVX203	EVX204/5	EVX214/5	ENERGY SAVING IN REAL TIME
HE1	00:00	23:59	hr:min	not avail.	not avail.	00:00	00:00	time of activation of the Energy Saving in real time function; see also r4 and HE2
HE2	00:00	23:59	hr:min	not avail.	not avail.	00:00	00:00	duration of the Energy Saving in real time function; see also r4 and HE1 00:00 = the Energy Saving in real time function will not be activated
PAR.	MIN.	MAX.	UM	EVX201	EVX203	EVX204/5	EVX214/5	DEFROSTING IN REAL TIME
Hd1	00:00	23:59	hr:min	not avail.	not avail.	--:--	--:--	time of activation of first defrosting period in real time (only if d8 = 4) --:-- = the first defrosting in real time will not be activated
Hd2	00:00	23:59	hr:min	not avail.	not avail.	--:--	--:--	time of activation of second defrosting period in real time (only if d8 = 4) --:-- = the second defrosting in real time will not be activated
Hd3	00:00	23:59	hr:min	not avail.	not avail.	--:--	--:--	time of activation of third defrosting period in real time (only if d8 = 4) --:-- = the third defrosting in real time will not be activated
Hd4	00:00	23:59	hr:min	not avail.	not avail.	--:--	--:--	time of activation of fourth defrosting period in real time (only if d8 = 4) --:-- = the fourth defrosting in real time will not be activated
Hd5	00:00	23:59	hr:min	not avail.	not avail.	--:--	--:--	time of activation of fifth defrosting period in real time (only if d8 = 4) --:-- = the fifth defrosting in real time will not be activated
Hd6	00:00	23:59	hr:min	not avail.	not avail.	--:--	--:--	time of activation of sixth defrosting period in real time (only if d8 = 4) --:-- = the sixth defrosting in real time will not be activated
PAR.	MIN.	MAX.	UM	EVX201	EVX203	EVX204/5	EVX214/5	SERIAL NETWORK (MODBUS)
LA	1	247	----	247	247	247	247	instrument address
Lb	0	3	----	2	2	2	2	baud rate (0 = 2,400 baud, 1 = 4,800 baud, 2 = 9,600 baud, 3 = 19,200 baud)
LP	0	2	----	2	2	2	2	parity (0 = none, 1 = odd, 2 = even)

- (1) the unit of measurement depends on P2
- (2) Properly set the parameters corresponding to the regulators after modifying parameter P2
- (3) the parameter has effect even after an interruption in the power supply that occurs while the instrument is switched on
- (4) the time established with the parameter is counted even when the instrument is switched off
- (5) if parameter C1 is set to 0, the delay after the end of the cell probe error will be 2 min
- (6) the parameter differential is 2.0 °C/4 °F
- (7) if when the instrument is switched on, the condenser temperature is already above that established in parameter C7, then parameter C8 will not have effect
- (8) the instrument stores the defroster interval count every 30 min; the modification of parameter d0 takes effect following the end of the preceding interval or following the activation of manual defrosting.
- (9) the display returns to normal operation when, at the end of defrosting (EVX201 only) or at the end of evaporator fan disactivation (in EVX203, EVX204, EVX214, EVX205 and EVX215 only), the cell temperature falls below that at which the display was initially blocked (or if a temperature alarm is signaled)
- (10) if parameter P3 is set to 0 or 2, the instrument will function as if parameter d8 were set to 0
- (11) if when defrosting is activated, the operating duration of the compressor is less than the time established with parameter d5, the compressor will remain on for the amount of time necessary to complete defrosting.
- (12) if parameter P3 is set to 0, the instrument will function as if parameter A0 were set to 0 but it will not store the alarm
- (13) during defrosting and dripping and when the evaporator fan is stopped, the temperature alarms are absent, provided that these were signaled after the activation of defrosting
- (14) during activation of the door microswitch input, the maximum temperature alarm is absent, provided the alarm was signaled after the activation of the input
- (15) when power is restored, the alarm will always be signaled
- (16) if parameter P3 is set to 0, the instrument will function as if parameter F0 were set to 2
- (17) the parameter can also be modified using the procedure described in paragraph 4.8
- (18) if parameter P4 is set to 0, the condenser fan will function in parallel with the compressor
- (19) the compressor is switched off 10 sec after the activation of the input; if the input is activated during defrosting or when the evaporator fan is disactivated, the activation will not have any effect on the compressor
- (20) the instrument stores the alarm once the time established in parameter i2 has expired; if parameter i2 is set to -1, the instrument will not store the alarm
- (21) make sure that the time established with parameter i7 is less than that established with parameter i9
- (22) to avoid damaging the unit connected to the instrument, change the parameter setting when the instrument is switched off
- (23) if parameter u2 is set to 0, switching off the instrument may cause the cell light and/or the auxiliary output to switch off (the next time the instrument is switched on the unit connected will remain switched off); if parameter u2 is set to 1, switching off the instrument will not cause the cell light and/or the auxiliary output to switch off (the next time the instrument is switched on the unit connected will remain switched on).

### 13 ELECTRIC CONNECTION

#### 13.1 Preliminary notes

With reference to the electrical wiring diagrams:

- the unit connected to and operated by the fourth output depends on parameter u1 (EVX204, EVX214, EVX205 and EVX215 only)
- the unit connected to and operated by the fifth output depends on parameter u11 (EVX205 and EVX215 only)
- the serial port is the port for communicating with the monitoring system (via serial interface, via TTL, MODBUS communications protocol) or by programming key ; the port must not be used for two different purposes simultaneously.

#### 13.2 EVX201 electrical wiring

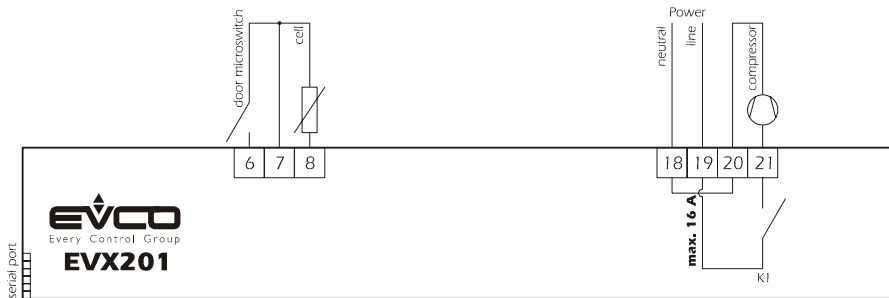

#### 13.3 EVX203 electrical wiring

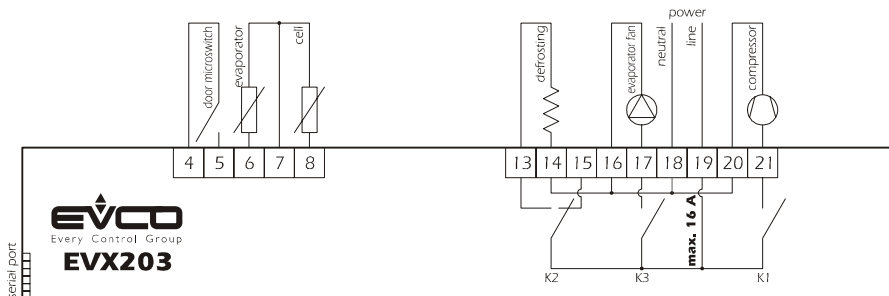

#### 13.4 EVX204, EVX214, EVX205 and EVX215 electrical wiring

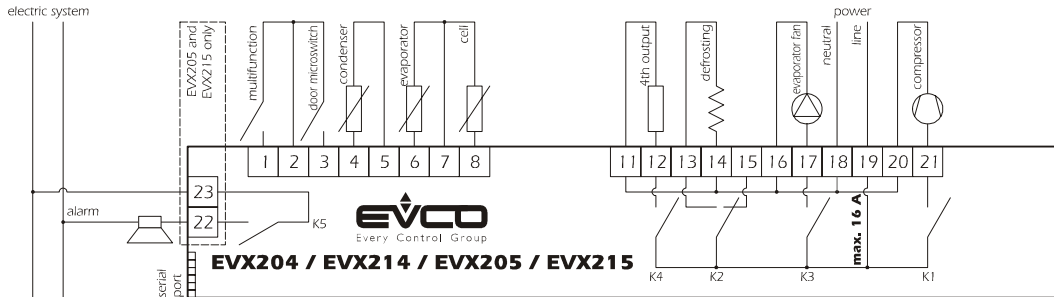

#### 13.5 Electrical wiring warnings

- do not use electric or pneumatic screwdrivers on the terminal boards
- if the instrument was brought from a cold place to a hot one, humidity may condense inside the instrument; wait approximately one hour before switching on the power
- make sure that the power tension, frequency, and the electric operating power of the instrument are compatible with the those of the local power voltage
- disconnect the power before performing any type of maintenance operation
- do not use the instrument as a safety device
- for information about the instrument and repairs contact a member of the Evco sales network