

# Compact series inverter

Inverter for medium power asynchronous motors

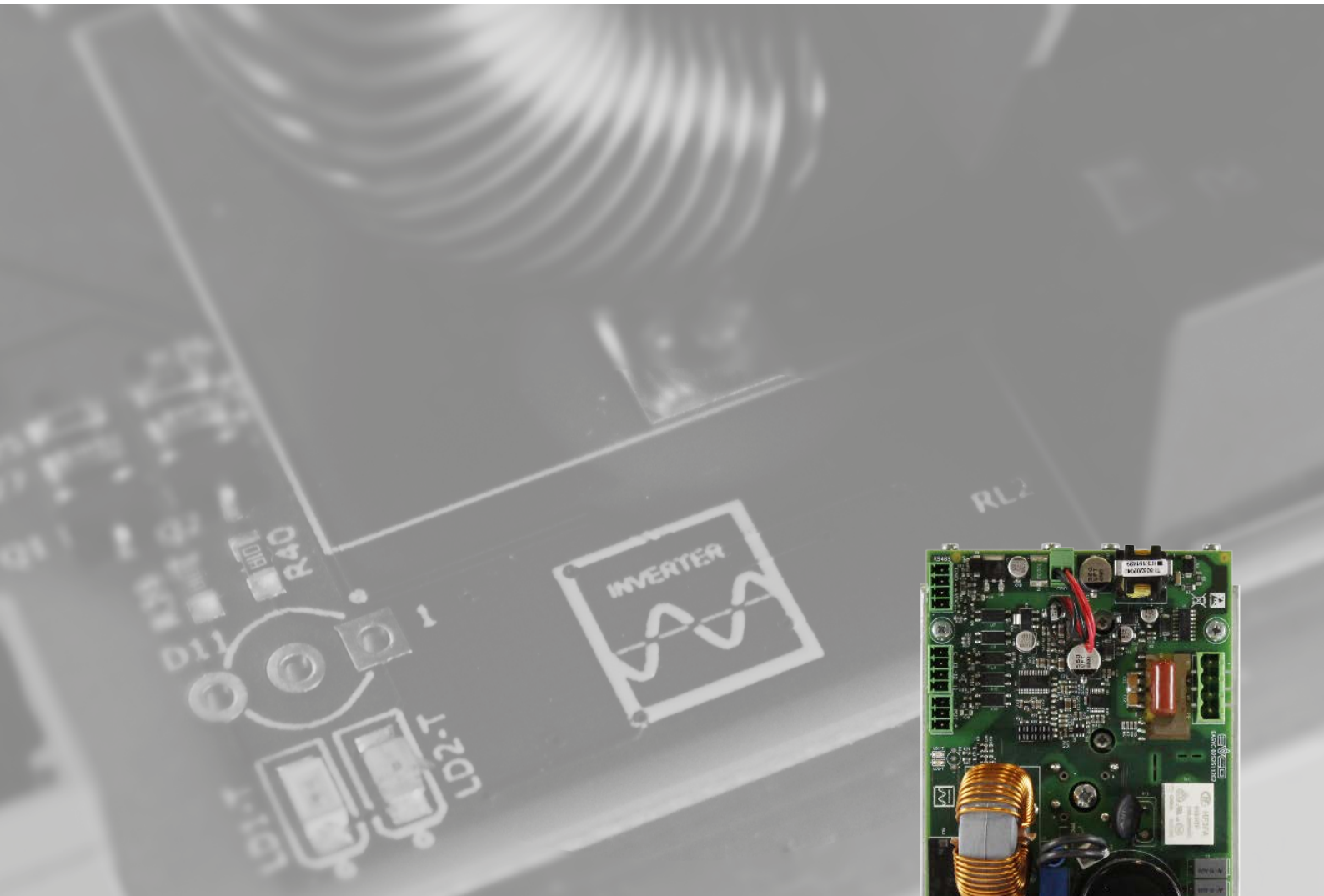



## CONTENTS

<b>IMPORTANT INFORMATION</b>	<b>4</b>
<b>IMPORTANT SAFETY INFORMATION</b>	<b>5</b>
<b>SAFETY INFORMATION RELATING TO THE PRODUCT</b>	<b>6</b>
<b>CHAPTER 1. INTRODUCTION</b>	<b>8</b>
<b>1.1 Compliance</b>	<b>8</b>
<b>CHAPTER 2. PURCHASING CODES</b>	<b>9</b>
<b>2.1 Purchasing codes table</b>	<b>9</b>
<b>CHAPTER 3. TECHNICAL DATA</b>	<b>10</b>
<b>3.1 Technical specifications</b>	<b>10</b>
<b>3.2 Other technical information</b>	<b>10</b>
<b>CHAPTER 4. MECHANICAL ASSEMBLY</b>	<b>11</b>
<b>4.1 Installing the Compact Inverter</b>	<b>11</b>
<b>4.2 Minimum installation distances</b>	<b>12</b>
<b>4.3 Compact Inverter dimensions</b>	<b>13</b>
<b>CHAPTER 5. ELECTRICAL CONNECTIONS</b>	<b>14</b>
<b>5.1 Connection best practice</b>	<b>14</b>
<b>5.1.1 Wiring best practices</b>	<b>15</b>
<b>5.2 Wiring diagram</b>	<b>16</b>
<b>5.2.1 Earthing</b>	<b>17</b>
<b>CHAPTER 6. OPERATION</b>	<b>18</b>
<b>6.1 Control types</b>	<b>18</b>
<b>6.2 Protection</b>	<b>18</b>
<b>6.3 LED</b>	<b>18</b>
<b>6.4 AUTORESET function</b>	<b>18</b>
<b>6.5 SAFE START function</b>	<b>18</b>
<b>CHAPTER 7. CONFIGURATIONS</b>	<b>19</b>
<b>7.1 Control via analogue and digital input</b>	<b>19</b>
<b>7.1.1 Wiring diagram</b>	<b>19</b>
<b>7.1.2 Parameter configuration</b>	<b>19</b>
<b>7.2 Control via FM</b>	<b>20</b>
<b>7.2.1 Wiring diagram</b>	<b>20</b>
<b>7.2.2 Parameter configuration</b>	<b>20</b>
<b>7.3 Control via Slave Serial port</b>	<b>21</b>
<b>7.3.1 Wiring diagram</b>	<b>21</b>
<b>7.3.2 Parameter configuration</b>	<b>21</b>



## CONTENTS

---

<b>CHAPTER 8. PARAMETERS</b>	<b>22</b>
<b>8.1 Table of configuration parameters</b>	<b>22</b>
<b>8.2 Table of Modbus commands</b>	<b>25</b>
<b>8.3 Serial communication settings</b>	<b>25</b>
<b>8.4 Table of Modbus variables</b>	<b>26</b>
<b>8.5 Table of monitor data</b>	<b>28</b>
<b>CHAPTER 9. ALARMS</b>	<b>29</b>
<b>9.1 Table of alarms</b>	<b>29</b>
<b>CHAPTER 10. PARAMETERS MANAGER</b>	<b>30</b>
<b>CHAPTER 11. WARRANTY</b>	<b>32</b>

---

---

## IMPORTANT INFORMATION

---

### Liability and residual risks

EVCO assumes no liability for any damage caused by the following (by way of example; this is not an exhaustive list):

- Installation/use for purposes other than those specified and, in particular, not adhering to the safety provisions set out by current regulations in the country in which the product is installed and/or contained in this manual;
- Use in appliances that do not guarantee sufficient protection against electric shocks, water and dust within the installation conditions created;
- Use in appliances that allow access to hazardous parts without the use of a keyed or tooled locking mechanism when accessing the instrument;
- Tampering and/or modifying the product;
- Installation/use in appliances which do not comply with current regulations in the country in which the product is installed.

The customer/manufacturer is responsible for ensuring their machine complies with these regulations.

EVCO's responsibility is limited to the correct and professional use of the product in accordance with regulations and the instructions contained in this manual and other product support documents.

To comply with EMC standards, observe all the electrical connection instructions. As it depends on the wiring configuration as well as the load and the installation type, compliance must be verified for the final machine as specified by the relevant product standard.

### Disclaimer

This document is the exclusive property of EVCO. It contains a general description and/or a description of the technical specifications for the services offered by the products listed herein. This document should not be used to determine the suitability or reliability of these products in relation to specific user applications. Each user or integration specialist should conduct their own complete and appropriate risk analysis, in addition to carrying out a product evaluation and test in relation to its specific application or use. Users can send us comments and suggestions on how to improve or correct this publication.

Neither EVCO nor any of its associates or subsidiaries shall be held responsible or liable for improper use of the information contained herein.

EVCO has a policy of continuous development. Therefore, EVCO reserves the right to make changes and improvements to any product described in this document without prior notice.

The images in this document and other documentation supplied with the product are provided for illustrative purposes only and may differ from the product itself.

The technical data in this manual is subject to change without prior notice.

### Terms and Conditions of use

#### Permitted use

The device must be installed and used in accordance with the instructions provided and, in particular, hazardous live parts must not be accessible under normal conditions.

The device must be suitably protected from water and dust with regard to its application and must also only be accessible with the aid of a tool.

Only qualified personnel may install the product or perform technical support procedures on it.

The customer must only use the product as described in the documentation relating to that product.

#### Prohibited use

Any use other than those described in the "Permitted use" section and in the product support documentation is prohibited.

**The product must be installed outside hazardous ATEX areas.**

### Disposal



The device must be disposed of in accordance with local regulations regarding the collection of electrical and electronic appliances.

### Consider the environment



With a view to respecting the environment, we strive to adhere to the environmental performance of the company, while taking account of customer requirements, technological innovations in terms of materials and the expectations of the community to which we belong. EVCO places great importance on respecting the environment, encouraging all associates to become involved with company values and guaranteeing safe, healthy and functional working conditions and workplaces.

**Please consider the environment before printing this document.**

## IMPORTANT SAFETY INFORMATION

Please read this document carefully before installation; study all the warnings before using the device. Only use the device in accordance with the methods described in this document. The following safety messages may be repeated several times in the document, to provide information regarding potential hazards or to attract attention to information which may be useful in explaining or clarifying a procedure.



This symbol is used to indicate a risk of electric shock.  
It is a safety indication and as such, should be observed to avoid potential accidents or fatalities.



This symbol is used to indicate a risk of serious personal injury.  
It is a safety indication and as such, should be observed to avoid potential accidents or fatalities.

### DANGER

**DANGER** indicates a situation of imminent danger which, if not avoided, **will lead to death or serious injury**.

### WARNING

**WARNING** indicates a situation of imminent danger which, if not avoided, **may lead to death or serious injury**.

### CAUTION

**CAUTION** indicates a potentially hazardous situation which, if not avoided, **could cause minor or moderate injury**.

### NOTICE

**NOTICE** indicates a situation not related to physical injuries but which, if not avoided, could damage the equipment.

**NOTE:** The maintenance, repair, installation and use of electrical equipment must only be entrusted to qualified personnel.

#### QUALIFIED PERSONNEL

Only suitably trained and experienced personnel capable of understanding the content of this manual and all documentation regarding the product are authorised to work on and with this equipment. Furthermore, the personnel must have completed courses in safety and must be able to recognise and prevent the implied dangers. The personnel must have suitable training, knowledge and experience at a technical level, and be capable of anticipating and detecting potential risks caused by using the product, as well as changing the settings and modifying the mechanical, electric and electronic equipment for the entire system in which the product is used. All personnel working on and with the product must be entirely familiar with the relevant standards and directives, as well as safety regulations.

## SAFETY INFORMATION RELATING TO THE PRODUCT

Before carrying out any work on the equipment, read these instructions carefully, making sure you understand everything.

### DANGER

#### RISK OF ELECTRIC SHOCK, EXPLOSION OR ELECTRIC ARC

- Only suitably trained personnel, familiar with and capable of understanding the content of the manual and all relevant documentation, are authorised to work on and with this inverter. Furthermore, the personnel must have completed courses in safety and must be able to recognise and prevent the implied dangers. Installation, adjustment and maintenance must only be carried out by qualified personnel.
- Various product components, including the printed circuits, run at hazardous voltage levels.
- Only use electrically insulated and suitably calibrated measuring devices and equipment.
- Do not handle the equipment while the power supply is connected.
- Do not touch the unshielded components or the terminals while they are live.
- The motors may generate voltage if the shaft is rotated. Before carrying out any work on the inverter, lock the motor shaft to prevent it from rotating.
- Before working on the inverter:
  - Disconnect the power supply.
  - Use a suitably calibrated and electrically insulated Voltmeter to make sure the power supply is disconnected.
  - Wait for 5 minutes after disconnecting the power supply before installing/uninstalling accessories, hardware, cables or wires, to allow the condensers to discharge any residual voltage.
- Do not open, disassemble, repair or modify the product.
- Before handling the product, make sure you are wearing all the necessary personal protective equipment (PPE).
- Do not expose the equipment to liquids or chemicals.
- Before applying voltage to the inverter:
  - Make sure the running period has been completed and no parts of the system can become hazardous.
  - If the mains power supply terminals and the motor output terminals have been earthed and circuited, remove the earth and short circuits on these terminals.
  - Make sure all the equipment is properly earthed.
  - Make sure all protective elements, such as covers, hatches and grilles, are fitted and/or closed.
  - Check all wiring connections.

### DANGER

#### RISK OF ELECTRIC SHOCK AND FIRE

- Do not use the device with loads greater than those indicated in the technical data section.
- Do not exceed the temperature and humidity ranges indicated in the technical data section.
- Use the required safety interlocks (fuses and/or magnetothermal switches) of a suitable size between the power supply and the inverter.

### DANGER

#### RISK OF ELECTRIC SHOCK OR MALFUNCTIONING OF THE EQUIPMENT

Do not use damaged products or accessories.

This device was designed to operate in non-hazardous environments, excluding applications that generate, or could potentially generate, hazardous atmospheres. Only install this device in areas and for applications which are reliably free from hazardous atmospheres.

### DANGER

#### RISK OF EXPLOSION

- Only install and use this device in sites that are not at risk.
- Do not install or use this device in applications which are capable of generating hazardous atmospheres, such as applications that use flammable refrigerants.

The **Compact** inverter must be installed in a suitably ventilated environment to allow heat to dissipate.  
The temperature of the device can exceed 80 °C (176 °F) during operation.

**⚠ WARNING**

**HOT SURFACES**

- Avoid all contact with hot surfaces.
- Do not leave flammable or heat-sensitive components on or near hot surfaces.
- Make sure the product has cooled sufficiently before handling it.
- Make sure sufficient heat dissipation takes place by performing a test under maximum load conditions.

**⚠ WARNING**

**MALFUNCTIONING OF THE EQUIPMENT**

- Perform the wiring carefully, in compliance with electromagnetic compatibility requirements.
- Do not operate the product with unknown or incorrect settings or data.
- Carry out a full start-up test.
- Make sure the wiring is correct for the settings.
- Use shielded cables for all I/O signal and communication cables.
- Use double-shielded cables for motor wiring.
- Minimise the length of the connections as much as possible, to avoid winding the cables around electrically connected parts.
- The signal (communication and corresponding power supplies) and power cables for the device must be routed separately.
- Before applying the power supply, check all the wiring connections.

---

## CHAPTER 1. INTRODUCTION

---

The series of **Compact** inverters is designed to control asynchronous motors with a power of up to 2.3 kW.  
Operating environments for this series of products are:

- Modulating fans;
- Food mixers.

It uses scalar or vector motor control, depending on application requirements.

### 1.1 Compliance

**2014/35/UE:** Low voltage directive applied in accordance with standard EN61800-5-1 for electrical safety.

**2014/30/UE:** Electromagnetic compatibility directive applied in accordance with standard EN61800-3 class C2.



## CHAPTER 2. PURCHASING CODES

### 2.1 Purchasing codes table

The table below illustrates the main features of available **Compact** series inverters and the corresponding purchasing codes:

Features		Models			
		EI750M2C0400VXX	EI1K5M2C0400VXX	EI2K2M2C0400VXX	EI2K3M2C0400VXX
Power supply	230 Vac $\pm$ 10%	•	•	•	•
Power levels	0.75 kW	•	/	/	/
	1.5 kW	/	•	/	/
	2.2 kW	/	/	•	/
	2.3 kW	/	/	/	•
Digital inputs	NPN(*)	3	3	3	3
Analogue inputs	0...10 V	1	1	1	1
Digital outputs	1 relay 5 A 230 Vac	•	•	•	•
Indicator LED	1 Red LED	•	•	•	•
	1 Green LED	•	•	•	•
Installation	Panel	•	•	•	•
Terminal blocks	Quick-disconnect screw type	•	•	•	•
Communication ports	RS-485 MODBUS SLAVE	•	•	•	•

**NOTE:** For further information, consult “CHAPTER 3. TECHNICAL DATA” ON PAGE 10.

(\*) = PNP on request; contact the sales office for more information.

### COMBI application purchasing codes table

Features		Models			
		EI750M2C2400VXX	EI1K5M2C2400VXX	EI2K2M2C2400VXX	EI2K3M2C2400VXX
Power supply	230 Vac $\pm$ 10%	•	•	•	•
Power levels	0.75 kW	•	/	/	/
	1.5 kW	/	•	/	/
	2.2 kW	/	/	•	/
	2.3 kW	/	/	/	•
Digital inputs	NPN(*)	3	3	3	3
Analogue inputs	0...10 V	1	1	1	1
Digital outputs	1 relay 5 A 230 Vac	•	•	•	•
Indicator LED	1 Red LED	•	•	•	•
	1 Green LED	•	•	•	•
Installation	Panel	•	•	•	•
Terminal blocks	Quick-disconnect screw type	•	•	•	•
Communication ports	RS-485 MODBUS SLAVE	•	•	•	•

For the communication parameters of the models dedicated to the COMBI application, refer to the manual:

- **114EV07I4.00 MAN EVOLVE COMBI IT**
- **114EV07E4.00 MAN EVOLVE COMBI EN**

## CHAPTER 3. TECHNICAL DATA

### 3.1 Technical specifications

Ambient operating conditions:	-10...50 °C (14...122 °F) 10 ... 90% RH non-condensing
Transportation and storage conditions:	-20...60 °C (-4...140 °F) 10 ... 90% RH non-condensing
Altitude:	Maximum 1000 m (3280 ft)
Pollution category:	2
Protection degree:	IP00
Overvoltage category:	II
Power supply:	230 Vac ±10% 50/60 Hz
Input current (RMS):	<b>0.75 kW:</b> 4.8 A <b>1.5 kW:</b> 9.5 A <b>2.2 kW:</b> 13.6 A <b>2.3 kW:</b> 13.6 A
Output current (RMS):	<b>0.75 kW:</b> 2.9 A <b>1.5 kW:</b> 5.5 A <b>2.2 kW:</b> 7.8 A <b>2.3 kW:</b> 7.9 A
Cooling method:	<b>0.75 kW models:</b> Natural ventilation <b>Other models:</b> Forced ventilation

### 3.2 Other technical information

#### Input properties (SELV)

Digital inputs:	3 multifunctional configurable digital inputs
Analogue inputs:	1 configurable analogue input 0...10 V / 0...5 V

#### Output properties

Digital outputs:	1 relay output 5 A at 250 Vac (configurable)
Motor output:	0...230 Vac, 3 ph at $V_{in} = 230$ Vac
Carrier frequency:	5...16 kHz
Nominal overload:	Maximum 150% for 60 seconds
Output frequency:	0...100 Hz

#### Serial communication port properties (SELV)

RS-485 serial port:	1 opto-isolated RS-485 MODBUS RTU Slave serial port, reinforced for remote connection Maximum baud rate: 38400 bps - Maximum cable length: 1.5 m (4.9 ft.)
---------------------	---

#### Cable properties:

Minimum operating temperature: 85 °C (185 °F)

#### Compliance

CE in accordance with directives EN61800-3 in C2 category and EN61800-5-1.

## CHAPTER 4. MECHANICAL ASSEMBLY

### 4.1 Installing the Compact Inverter

**Compact** inverter installation anticipates the use of a corner bracket (not supplied).

In particular, the safety instructions, electrical requirements and current regulations for the machine or the process in which this device is involved must be observed.

#### DANGER

##### RISK OF ELECTRIC SHOCK, EXPLOSION OR ELECTRIC ARC

- Before handling the product, make sure you are wearing all the necessary personal protective equipment (PPE).
- Do not handle the equipment while the power supply is connected.
- Do not expose the equipment to liquids or chemicals.
- Before applying voltage to the inverter:
  - Make sure the running period has been completed and no parts of the system can become hazardous.
  - If the mains power supply terminals and the motor output terminals have been earthed and circuited, remove the earth and short circuits on these terminals.
  - Make sure all the equipment is properly earthed.
  - Make sure all protective elements, such as covers, hatches and grilles, are fitted and/or closed.
- Check all wiring connections.

This device was designed to operate in non-hazardous environments, excluding applications that generate, or could potentially generate, hazardous atmospheres. Only install this device in areas and for applications which are reliably free from hazardous atmospheres.

#### DANGER

##### RISK OF EXPLOSION

- Only install and use this device in sites that are not at risk.
- Do not install or use this device in applications which are capable of generating hazardous atmospheres, such as applications that use flammable refrigerants.

#### 0.75 kW models

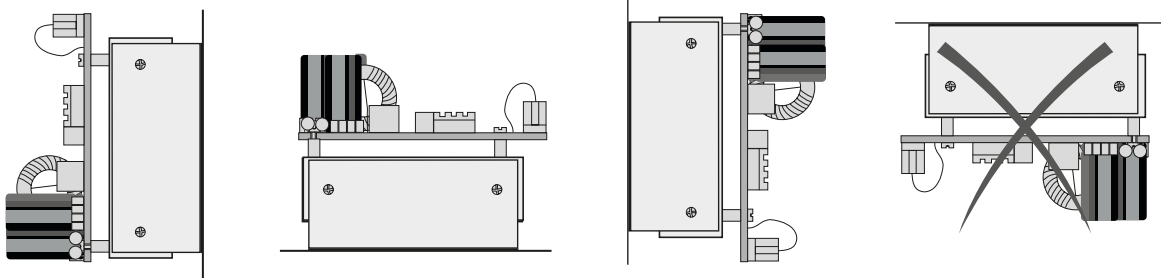

#### 1.5 kW / 2.2 kW / 2.3 kW models

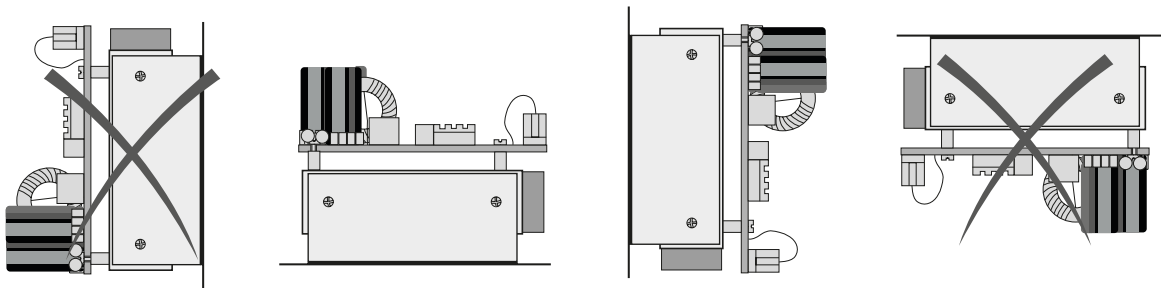

**Fig. 1. Compact installation positioning**

## 4.2 Minimum installation distances

Install the **Compact** inverter observing the minimum distance of 40 mm (1.57 in.) on each side, so as to guarantee adequate ventilation and aeration of the system. Make sure there is a distance of at least 10 mm (0.39 in.) between the support base and the cooler.

### **⚠ WARNING**

#### **HOT SURFACES**

- Avoid all contact with hot surfaces.
- Do not leave flammable or heat-sensitive components on or near hot surfaces.
- Make sure the product has cooled sufficiently before handling it.
- Make sure sufficient heat dissipation takes place by performing a test under maximum load conditions.

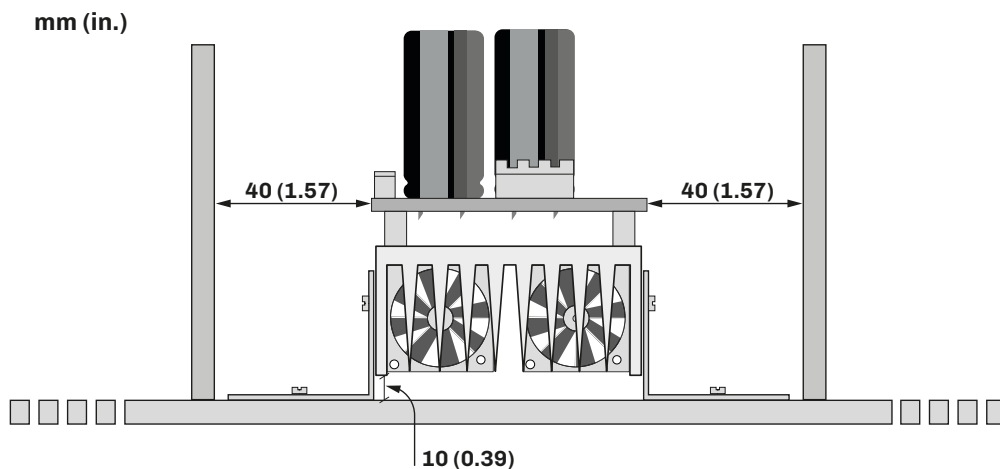

**Fig. 2.** Minimum installation distances - view from below

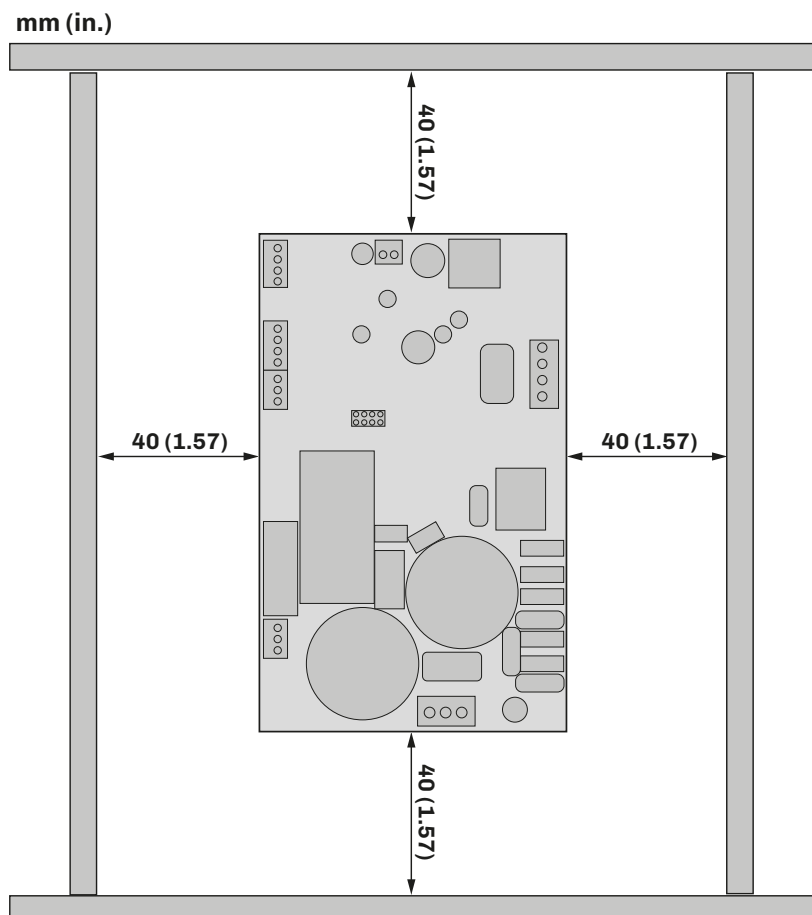

**Fig. 3.** Minimum installation distances - front view

### 4.3 Compact Inverter dimensions

mm (in.)

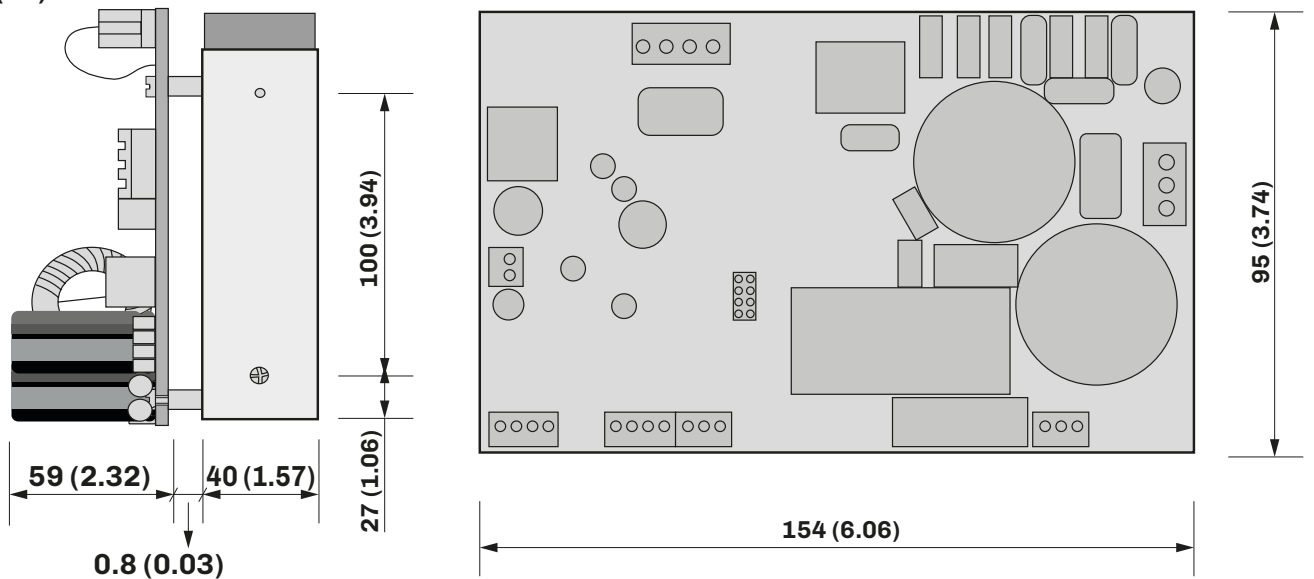

Fig. 4. Compact Inverter dimensions

## CHAPTER 5. ELECTRICAL CONNECTIONS

### 5.1 Connection best practice

The following information describes the wiring guidelines and best practices which should be observed when using the inverter.

#### DANGER

##### RISK OF ELECTRIC SHOCK, EXPLOSION OR ELECTRIC ARC

- Only suitably trained personnel, familiar with and capable of understanding the content of the manual and all relevant documentation, are authorised to work on and with this inverter. Furthermore, the personnel must have completed courses in safety and must be able to recognise and prevent the implied dangers. Installation, adjustment and maintenance must only be carried out by qualified personnel.
- Various product components, including the printed circuits, run at hazardous voltage levels.
- Only use electrically insulated and suitably calibrated measuring devices and equipment.
- Do not handle the equipment while the power supply is connected.
- Do not touch the unshielded components or the terminals while they are live.
- The motors may generate voltage if the shaft is rotated. Before carrying out any work on the inverter, lock the motor shaft to prevent it from rotating.
- Before working on the inverter:
  - Disconnect the power supply.
  - Use a suitably calibrated and electrically insulated Voltmeter to make sure the power supply is disconnected.
  - Wait for 5 minutes after disconnecting the power supply before installing/uninstalling accessories, hardware, cables or wires, to allow the condensers to discharge any residual voltage.
- Do not open, disassemble, repair or modify the product.
- Before handling the product, make sure you are wearing all the necessary personal protective equipment (PPE).
- Do not expose the equipment to liquids or chemicals.
- Before applying voltage to the inverter:
  - Make sure the running period has been completed and no parts of the system can become hazardous.
  - If the mains power supply terminals and the motor output terminals have been earthed and circuited, remove the earth and short circuits on these terminals.
  - Make sure all the equipment is properly earthed.
  - Make sure all protective elements, such as covers, hatches and grilles, are fitted and/or closed.
- Check all wiring connections.

#### DANGER

##### RISK OF ELECTRIC SHOCK AND FIRE

- Do not use the device with loads greater than those indicated in the technical data section.
- Do not exceed the temperature and humidity ranges indicated in the technical data section.
- Use the required safety interlocks (fuses and/or magnetothermal switches) of a suitable size between the power supply and the inverter.
- Only use cables with a suitable cross-section as indicated in the section "Wiring best practices".

When the inverter is in standby and the motor is not running, the latter remains live.

#### DANGER

##### RISK OF ELECTRIC SHOCK

Do not handle the motor when the inverter is in standby.

### 5.1.1 Wiring best practices

When wiring the controllers, observe the following instructions:

- The I/O and communication wiring must be kept separate from the power supply wiring. These two types of wiring must be routed in separate ducts.
- Make sure the operating environment and conditions fall within the specified values.
- Use wires with the correct diameter, suited to the voltage and current requirements.
- Use copper conductors (compulsory).
- Use shielded twisted pair cables for analogue I/O connections.
- Use shielded twisted pair cables for network and RS-485 serial connections.

Use correctly earthed shielded cables for all inputs or analogue outputs, for communication connections and for motor wiring.

## ⚠ WARNING

### MALFUNCTIONING OF THE EQUIPMENT

- Perform the wiring carefully, in compliance with electromagnetic compatibility and safety requirements.
- Carry out a full start-up test.
- Make sure the wiring is correct for the settings.
- Use shielded cables for all I/O signal and communication cables.
- Use double-shielded cables for motor wiring.
- Minimise the length of the connections as much as possible, to avoid winding the cables around electrically connected parts.
- The signal (communication and corresponding power supplies) and power cables for the device must be routed separately.
- Before applying the power supply, check all the wiring connections.

### Suitable wiring for the power supply

Step 5.08 mm (0.199 in.)









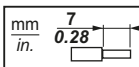

									 Ø 3.5 mm (0.14 in.)	 C	N•m 0.5...0.6 lb-in 4.42...5.31	
	mm <sup>2</sup>	0.2...2.5	0.2...2.5	0.25...2.5	0.25...2.5	2 x 0.2...1	2 x 0.2...1.5	2 x 0.25...1				2 x 0.5...1.5
	AWG	24...14	24...14	22...14	22...14	2 x 24...18	2 x 24...16	2 x 22...18				2 x 20...16

Fig. 5. Suitable wiring for the power supply

### Suitable wiring for I/O SELV

Step 3.5 mm (0.137 in.)

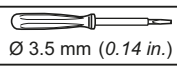







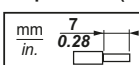

									 Ø 3.5 mm (0.14 in.)	 C	N•m 0.5...0.6 lb-in 4.42...5.31	
	mm <sup>2</sup>	0.14...1.5	0.14...1.5	0.25...1.5	0.25...0.5	2 x 0.08...0.5	2 x 0.08...0.5	2 x 0.25...0.34				2 x 0.5...0.5
	AWG	25...15	25...15	22...15	22...20	2 x 28...20	2 x 28...20	2 x 23...21				2 x 20...20

Fig. 6. Suitable wiring for I/O SELV

### Suitable wiring for earthing

Step 5.08 mm (0.199 in.)

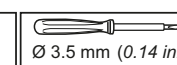



					 Ø 3.5 mm (0.14 in.)	 C	N•m 0.5...0.6 lb-in 4.42...5.31	
	mm <sup>2</sup>	2.5	2.5	2.5				2 x 1.5
	AWG	14	14	14				2 x 16

Fig. 7. Suitable wiring for earthing

## 5.2 Wiring diagram

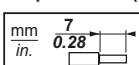

TERMINALS	
L	PHASE - Power supply input
N	NEUTRAL - Power supply input
PE	EARTH - Power supply input (*)
RS-485	RS-485 serial port for remote connection
U	Motor control output
V	Motor control output
W	Motor control output
PE	Motor earth connection (*)
I1...I3	Digital inputs 1...3
COM	Digital input common
NC	Relay output normally closed
C	Relay output common
NO	Relay output normally open
+12 V	Cooler fans power supply
GND	
-	Analogue input for potentiometer with 5 Vdc power supply
Pot	
+	

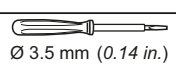
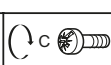
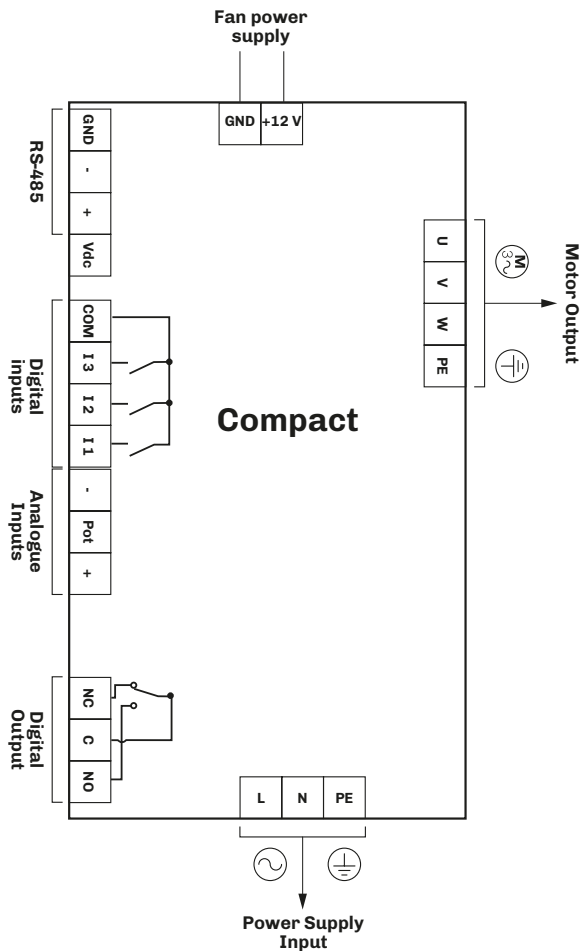
(\*) **NOTE:** For board and motor output earthing, see paragraph "5.2.1 EARTHING" ON PAGE 17.



### 5.2.1 Earthing

**⚡ ⚠ DANGER**

**RISK OF ELECTRIC SHOCK, EXPLOSION OR ELECTRIC ARC**

Make sure all the equipment is properly earthed.

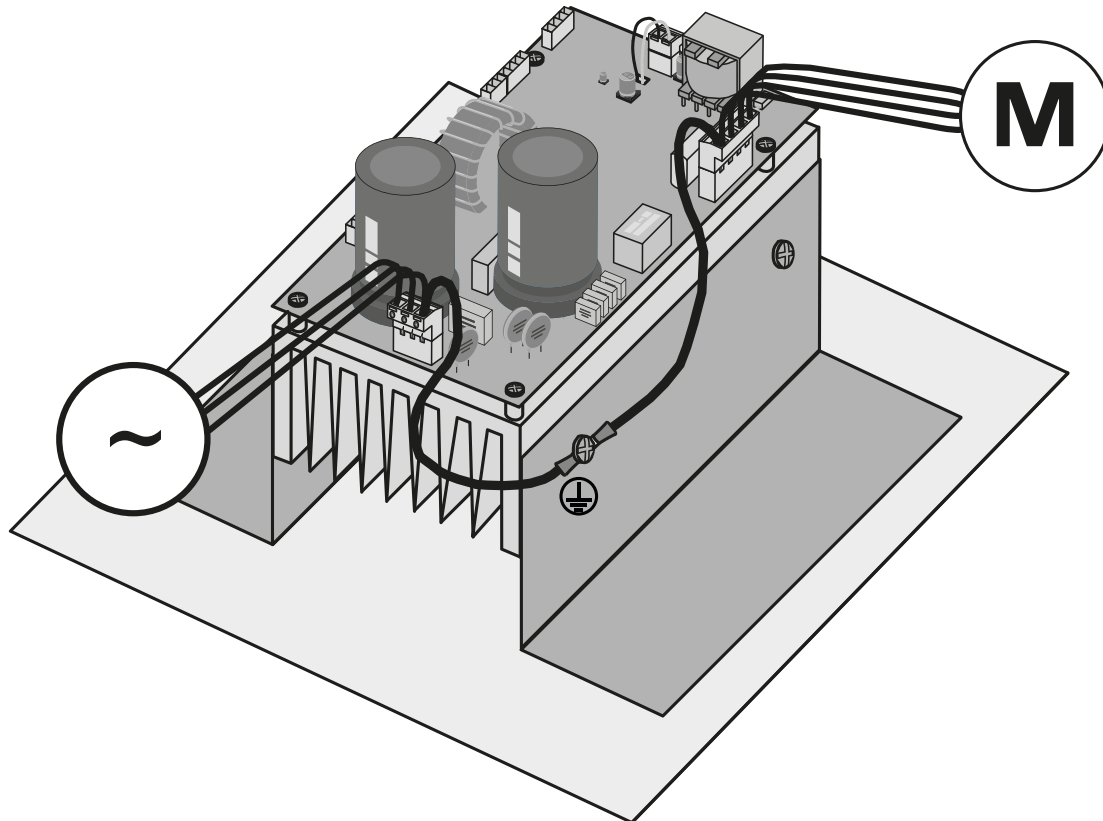

**Fig. 8. Compact Inverter earthing**

The inverter may have a dispersion current to earth that is greater than 3.5 mA.

**⚡ ⚠ DANGER**

**RISK OF ELECTRIC SHOCK AND FIRE**

Use correctly sized differentials on the earth line.

---

## CHAPTER 6. OPERATION

---

The **Compact** inverter controls asynchronous motors by powering variable frequency windings.  
The maximum switching frequency is 16 kHz.

### 6.1 Control types

Depending on the field of application, parameter **S103** can be used to choose one of the following control types:

- Scalar control (V/f) with an open loop, or
- Sensorless vector control.

### 6.2 Protection

The inverter is protected against:

- Overcurrent;
- Overvoltage;
- Undervoltage;
- Overload, or
- Overtemperature (the inverter automatically reduces the motor speed in the event of overtemperature).

For more details on these and other faults, please refer to **“CHAPTER 9. ALARMS” ON PAGE 29**.

### 6.3 LED

The LEDs on the board:

- If lit in Green: Inverter in RUN status;
- If lit in RED: Inverter in STOP status;
- If lit in Red and Green at the same time: Safe Start Enabled;
- If flashing in Red: Inverter in Alarm (see Alarms chapter).

### 6.4 AUTORESET function

The alarm AUTORESET function can be set using parameters **S104** and **S105**.

If enabled, this function ensures that the alarms are automatically reset after the time set in parameter **S105**.

### 6.5 SAFE START function

If you set parameter

- **S106 = 1;**

The Safe Start function is enabled (if **S106 = 0**, the function is disabled).

When Safe Start is enabled, and the inverter is powered, automatic start-up of the motor will be avoided and it will be necessary to provide another start-up input for motor start-up.

## CHAPTER 7. CONFIGURATIONS

3 types of configuration can be applied to the **Compact** inverter, depending on the motor control selected:

- Via analogue input 0...10 V and Digital input (start/stop),
- Via FM input;
- Via RS-485 serial port (Slave Serial port).

### 7.1 Control via analogue and digital input

#### 7.1.1 Wiring diagram

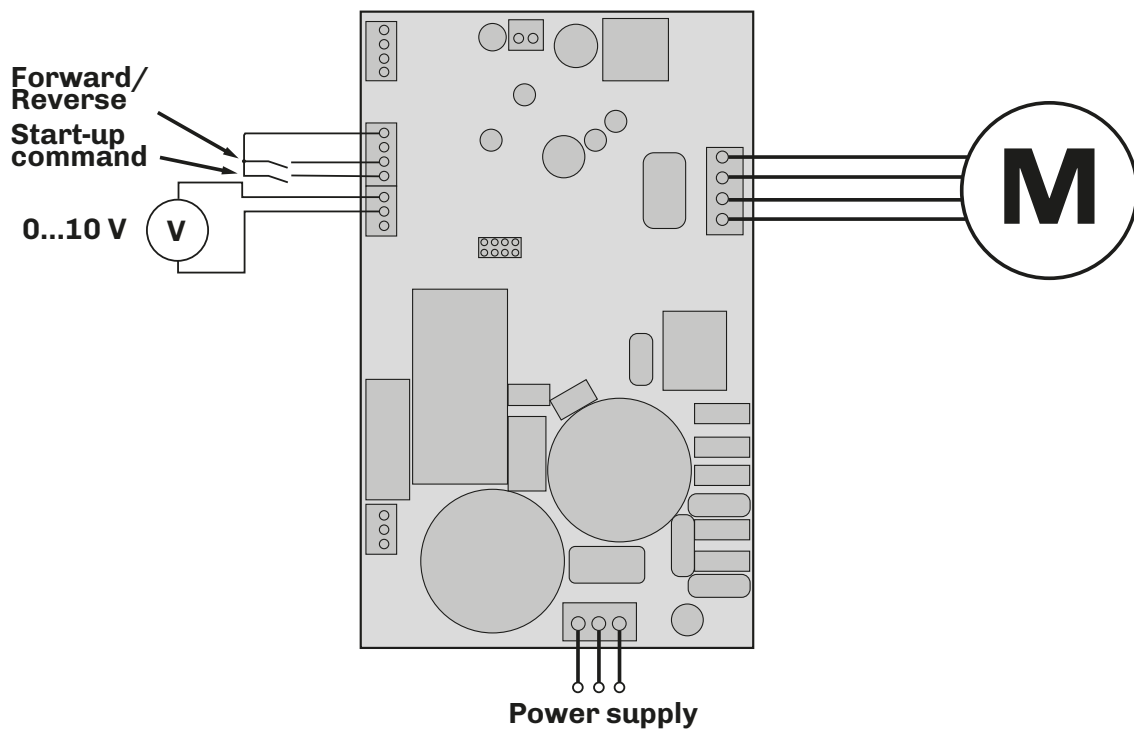

**Fig. 9. Wiring for inverter control via potentiometer**

#### 7.1.2 Parameter configuration

The parameter configuration required for **Compact** inverter control via potentiometer is as follows:

Par.	Description	MU	Range	Setting
<b>S101</b>	Selection of source for motor speed regulation.	-	1 ... 6	1
<b>S102</b>	Selection of source for start-up command.	-	1 ... 3	1
<b>S204</b>	Maximum motor speed.	rpm	<b>S205</b> ... 6000	1500
<b>S205</b>	Minimum motor speed.	rpm	37 ... <b>S204</b>	300
<b>S304</b>	Digital input 1 function.	-	0 ... 40	2
<b>S305</b>	Digital input 2 function.	-	0 ... 40	5
<b>S306</b>	Digital input 3 function.	-	0 ... 40	8
<b>S501</b>	Nominal motor current.	A	0.1 ... <b>S601</b>	(*)
<b>S502</b>	Nominal motor voltage.	V	50 ... 400	(*)
<b>S503</b>	Nominal motor frequency.	Hz	0 ... 100	(*)
<b>S504</b>	Number of pole pairs.	-	1 ... 8	(*)

(\*) depending on the motor rating label.

## 7.2 Control via FM

### 7.2.1 Wiring diagram

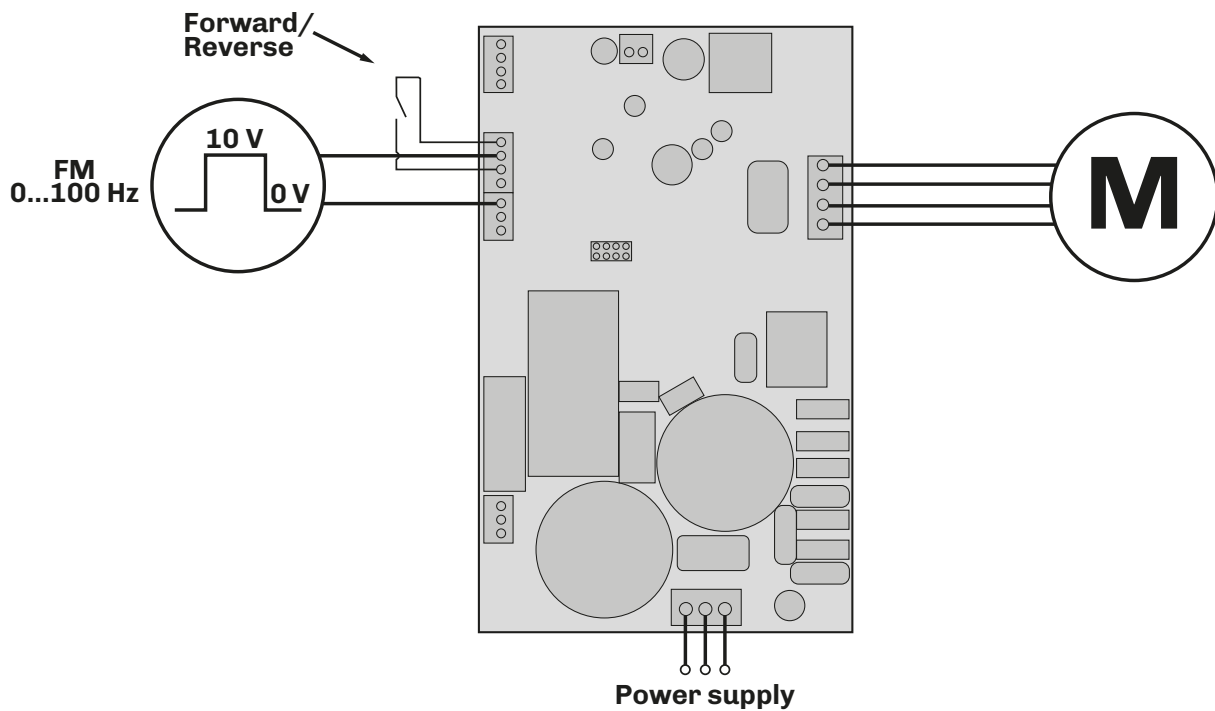

Fig. 10. Wiring for inverter control via FM

**FM:** Frequency modulation.

### 7.2.2 Parameter configuration

The parameter configuration required for **Compact** inverter control via FM is as follows:

Par.	Description	MU	Range	Setting
<b>S101</b>	Selection of source for motor speed regulation.	-	1 ... 6	6
<b>S102</b>	Selection of source for start-up command.	-	1 ... 3	3
<b>S204</b>	Maximum motor speed.	rpm	<b>S205</b> ... 6000	1500
<b>S205</b>	Minimum motor speed.	rpm	37 ... <b>S204</b>	300
<b>S305</b>	Digital input 2 function.	-	0 ... 40	5
<b>S306</b>	Digital input 3 function.	-	0 ... 40	18
<b>S501</b>	Nominal motor current.	A	0.1 ... <b>S601</b>	(*)
<b>S502</b>	Nominal motor voltage.	V	50 ... 400	(*)
<b>S503</b>	Nominal motor frequency.	Hz	0 ... 100	(*)
<b>S504</b>	Number of pole pairs.	-	1 ... 8	(*)

(\*) depending on the motor rating label.

## 7.3 Control via Slave Serial port

### 7.3.1 Wiring diagram

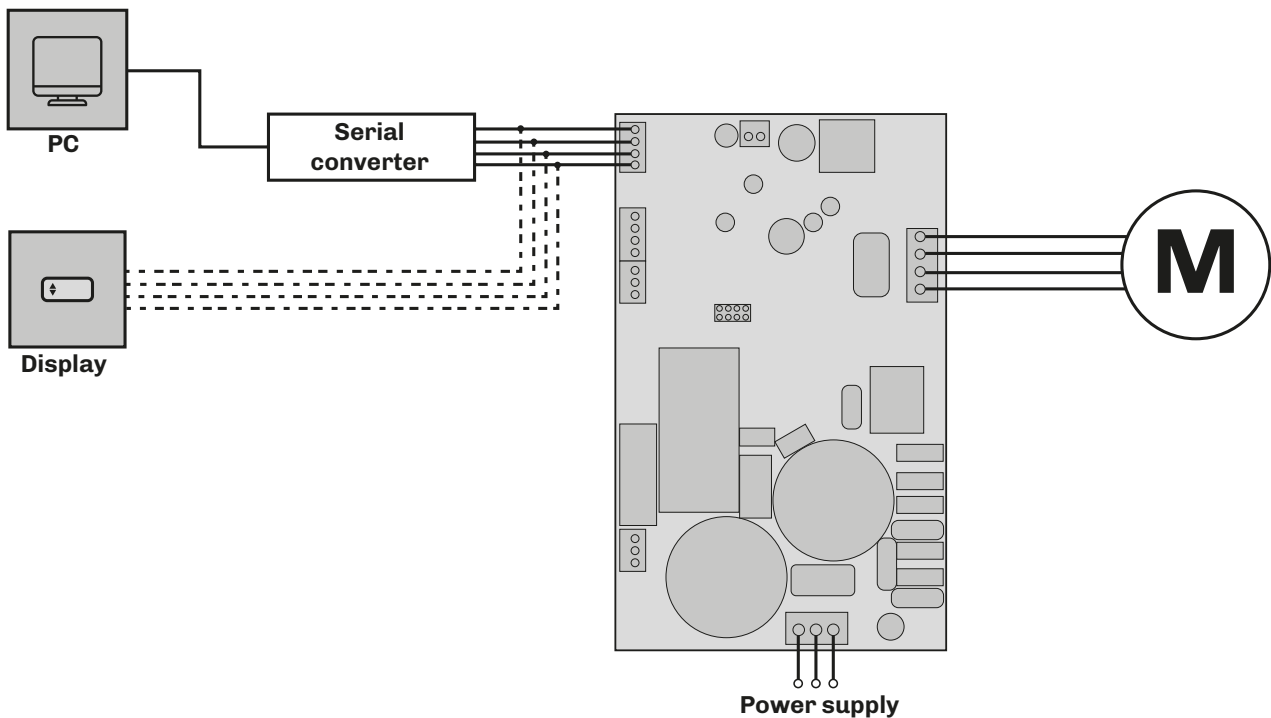

Fig. 11. Wiring for inverter control via Slave Serial port

### 7.3.2 Parameter configuration

The parameter configuration required for **Compact** inverter control via Slave serial port is as follows:

Par.	Description	MU	Range	Setting
<b>S101</b>	Selection of source for motor speed regulation.	-	1 ... 6	2
<b>S102</b>	Selection of source for start-up command.	-	1 ... 3	2
<b>S204</b>	Maximum motor speed.	rpm	<b>S205</b> ... 6000	1500
<b>S205</b>	Minimum motor speed.	rpm	37 ... <b>S204</b>	300
<b>S401</b>	Modbus communication protocol device address.	-	1 ... 247	1
<b>S402</b>	Baud rate. Transmission speed.	Baud	1 ... 3	1
<b>S403</b>	Time limit beyond which, if communication is not working, the device enters timeout alarm mode.	s	0.0 ... 60.0	2.0
<b>S501</b>	Nominal motor current.	A	0.1 ... <b>S601</b>	(*)
<b>S502</b>	Nominal motor voltage.	V	50 ... 400	(*)
<b>S503</b>	Nominal motor frequency.	Hz	0 ... 100	(*)
<b>S504</b>	Number of pole pairs.	-	1 ... 8	(*)

(\*) depending on the motor rating label.

## CHAPTER 8. PARAMETERS

**Compact** series inverter parameters can be configured using **Parameters Manager**, by connecting the inverter to the PC via RS-485 serial port. This means **Compact** series inverters are fully configurable according to your own requirements/applications.

**NOTE:** For PC - **Compact** series inverter connection, use an RS-485/USB converter (for example, p/n: **EVIF20SUXI**); for all necessary information on the subject, please refer to instruction sheet code **104SUXIA104**.

The parameters are divided into groups.

### Description of columns in the Table of Parameters

- **Par.:** List of configurable device parameters;
- **Description:** Indicates parameter operation and any possible selections;
- **MU:** Measurement unit relating to the parameter;
- **Range:** Describes the interval of values that the parameter can assume. This can be correlated with other instrument parameters (indicated with the parameter code).  
**NOTE:** if the actual value is outside the permitted limits for that parameter (for example, because other parameters defining the aforementioned limits have been altered), the value of the violated limit is displayed instead of the actual value;
- **Default:** Indicates the pre-set factory configuration;
- **PW:** Indicates the access level for the parameter.
- **Modbus address:** Indicates the address of the Modbus register containing the resource you want to access.

### 8.1 Table of configuration parameters

Par.	Description	MU	Range	Model default [kW]				PW	Modbus address
				0.75	1.5	2.2	2.3		
<b>CONTROL GROUP S1..</b>									
<b>S101</b>	Selection of source for motor speed regulation (*). 1 = Analogue input; 2 = RS-485 serial port; 3 = Multi-speed; 4 = Motor potentiometer without memory; 5 = Motor potentiometer with memory; 6 = FM digital input.	-	1 ... 6	1	1	1	1	C	101
<b>S102</b>	Selection of source for start-up command (*). 1 = Digital input; 2 = RS-485 serial port; 3 = Auto-start-up from analogue input (if S301 > 0.01).	-	1 ... 3	1	1	1	1	C	102
<b>S103</b>	Selection of control type applied to the motor. 1 = Scalar; 2 = Vector.	-	1 ... 2	1	1	1	1	C	103
<b>S104</b>	Autoreset selection. Indicates the number of automatic alarm resets with the exception of AI, EP, US (see " <b>CHAPTER 9. ALARMS</b> " ON <b>PAGE 29</b> ). 0 = Disabled.	-	0 ... 99	0	0	0	0	C	104
<b>S105</b>	Delay time for automatic alarm reset/restart after power-off.	s	0.1 ... 120.0	5.0	5.0	5.0	5.0	U	105
<b>S106</b>	Enable/Disable the Safe Start function. 0 = Function disabled; 1 = Function enabled.	-	0 ... 1	0	0	0	0	U	106
S107	Mains power failure management. 0 = No restart; 1 = Restart after failure < 5 s; 2 = Restart after failure ≥ 5 s.	-	0...2	0	0	0	0	U	107
<b>SPEED GROUP S2..</b>									
<b>S201</b>	Nominal target speed. If <b>S101</b> = 2, 4 or 5, the nominal speed is set.	rpm	<b>S205 ... S204</b>	1000	1000	1000	1000	U	201
<b>S202</b>	Acceleration ramp. Time required to reach the nominal speed from 0 rpm.	s	0.2 ... 200.0	3.0	3.0	3.0	3.0	U	202
<b>S203</b>	Deceleration ramp. Time required to reach 0 rpm from the nominal speed.	s	0.2 ... 200.0	5.0	5.0	5.0	5.0	U	203
<b>S204</b>	Maximum motor speed <sup>(1)</sup> .	rpm	<b>S205 ... 6000</b>	1500	1500	1500	1500	U	204

Par.	Description	MU	Range	Model default [kW]				PW	Modbus address
				0.75	1.5	2.2	2.3		
S205	Minimum motor speed <sup>(1)</sup> .	rpm	37 ... S204	300	300	300	300	U	205
S206	Select the motor rotation direction <sup>(2)</sup> . 0 = Clockwise; 1 = Anticlockwise.	-	0 ... 1	0	0	0	0	A	206
S207	Multi-speed 1 <sup>(3)</sup> .	rpm	S205 ... S204	1100	1100	1100	1100	U	207
S208	Multi-speed 2 <sup>(3)</sup> .	rpm	S205 ... S204	1200	1200	1200	1200	U	208
S209	Multi-speed 3 <sup>(3)</sup> .	rpm	S205 ... S204	1300	1300	1300	1300	U	209
S210	Multi-speed 4 <sup>(3)</sup> .	rpm	S205 ... S204	1400	1400	1400	1400	U	210
S211	Motor potentiometer step. Selection of the number of steps between minimum speed and maximum speed.	-	1 ... 100	10	10	10	10	U	211
S212	Torque reference. Torque threshold for activating the opposite motor rotation direction.	Nm	0.0 ... S507	0.0	0.0	0.0	0.0	U	212
S213	Reverse number. Select the number of attempts permitted with the opposite motor rotation direction.	-	0 ... 20	0	0	0	0	U	213
S214	Reverse time. Time during which the motor rotates in the opposite direction.	s	1 ... 200	5	5	5	5	U	214
S215	Speed jump 1.	rpm	S205 ... S204	300	300	300	300	U	215
S216	Speed jump 2.	rpm	S205 ... S204	300	300	300	300	U	216
S217	Speed jump band. Interval size for target speeds to be jumped. 0 = disabled.	rpm	0 ... S205	0	0	0	0	U	217
<b>INPUTS/OUTPUTS GROUP S3-</b>									
S301	Minimum analogue reference value. Selection of the minimum potentiometer voltage.	V	0.00 ... S302	0.00	0.00	0.00	0.00	A	301
S302	Maximum analogue reference value. Selection of the maximum potentiometer voltage.	V	S301 ... 10.00	10.00	10.00	10.00	10.00	A	302
S304	Digital input 1 function <sup>(4)</sup> . 1 = Enable (if S106 = 1); 2 = Stop/Run; 3 = Pulsed run; 4 = Pulsed stop; 5 = Clockwise/anti-clockwise direction; 6 = Stop/Run clockwise; 7 = Stop/Run anti-clockwise; 8 = Reset alarm; 9 = User alarm; 10 = Multi-speed 1; 11 = Multi-speed 2; 12 = Reserved; 13 = Motor potentiometer with input up; 14 = Motor potentiometer with input down; 15 = Reserved; 16 = Reserved; 17 = Motor thermal switch; 18 = Frequency tracking (FM). 19...40 = Reserved.	-	0 ... 40	2	2	2	2	C	304
S305	Digital input 2 function <sup>(4)</sup> . Same as S304.	-	0 ... 40	5	5	5	5	C	305
S306	Digital input 3 function <sup>(4)</sup> . Same as S304.	-	0 ... 40	8	8	8	8	C	306
S310	Output 1 function. Indicates the function/event that closes the relay contact, if applicable. 0 = Reserved; 1 = Inverter ready; 2 = Inverter in run; 3 = Inverter in alarm; 4 = Controlled by RS-485 serial port; 11...20 = Reserved.	-	0 ... 20	3	3	3	3	C	310
<b>MODBUS GROUP S4-</b>									
S401	Modbus communication protocol device address.	-	1 ... 247	1	1	1	1	A	401
S402	Baud rate. Transmission speed. 1 = 9600; 2 = 19200; 3 = 38400.	Baud	1 ... 3	1	1	1	1	A	402

Par.	Description	MU	Range	Model default [kW]				PW	Modbus address
				0.75	1.5	2.2	2.3		
<b>S403</b>	Time limit beyond which, if communication is not working, the device enters timeout alarm mode. <b>0</b> = Disabled.	s	0.0 ... 60.0	2.0	2.0	2.0	2.0	A	403
S404	Modbus protocol (bit/parity/stop bit). 0 = 8/None/1; 1 = 8/odd/1; 2 = 8/even/1; 3 = 8/None/2; 4 = 8/odd/2; 5 = 8/even/2. NOTE: Parameters manager does not manage protocols with 2 stop bits.	-	0...5	2	2	2	2	A	404
<b>Motor Group S5-</b>									
<b>S501</b>	Nominal motor current <sup>(4)</sup> .	A	0.1 ... <b>S601</b>	2.9	5.5	7.9	7.9	C	501
<b>S502</b>	Nominal motor voltage <sup>(4)</sup> .	V	50 ... 400	230	230	230	230	C	502
<b>S503</b>	Nominal motor frequency <sup>(4)</sup> .	Hz	0 ... 100	50	50	50	50	C	503
<b>S504</b>	Number of pole pairs <sup>(4)</sup> .	-	1 ... 8	2	2	2	2	C	504
<b>S505</b>	No-load current <sup>(4)</sup> .	A	0.1 ... <b>S501</b>	1.5	2.8	4.0	4.0	C	505
<b>S506</b>	Nominal motor revolutions <sup>(4)</sup> .	rpm	1 ... 3000	1390	1410	1430	1430	C	506
<b>S507</b>	Nominal torque <sup>(4)</sup> .	Nm	0.1 ... 100	5.2	10.2	14.7	14.7	C	507
<b>S508</b>	Cos(phi). Nominal motor power factor <sup>(4)</sup> .	-	0.01 ... 1.00	0.78	0.80	0.81	0.81	C	508
<b>S509</b>	Motor boost. Overvoltage percentage applied at motor start-up.	%	0 ... 25	5	5	5	10	C	509
<b>S510</b>	Motor voltage. Maximum voltage percentage applied to the motor in relation to the nominal value.	%	10 ... 112	100	100	100	108	C	510
<b>S511</b>	Motor overload. Motor overload percentage permitted by the inverter for a time set using parameter <b>S512</b> .	%	0 ... 50	50	50	50	50	C	511
<b>S512</b>	Maximum overload time.	s	0 ... 60	30	30	30	60	C	512
<b>S513</b>	Stop type. <b>0</b> = Coast-to-stop; <b>1</b> = Stop with ramp; <b>2</b> = Stop with DC voltage injection; <b>3</b> = Stop with ramp + DC voltage injection. The latter creates a ramp until the braking speed is reached, and then DC voltage is injected in the percentage set via parameter <b>S516</b> for a duration equal to <b>S515</b> , finally cutting off the motor power supply <sup>(5)</sup> . <b>NOTE: in alarm or emergency conditions, stoppage is always the free type.</b>	-	1 ... 3	1	1	1	1	C	513
<b>S514</b>	Speed at which to start braking in DC voltage. Only applies when <b>S513</b> = 3.	rpm	0 ... <b>S205</b>	0	0	0	0	C	514
<b>S515</b>	DC voltage braking duration. Only applies when <b>S513</b> = 2 or 3.	s	0.0 ... 20.0	0.0	0.0	0.0	0.0	C	515
<b>S516</b>	DC bus voltage percentage applied to the motor during braking with DC voltage. Only applies when <b>S513</b> = 2 or 3.	%	0 ... 50	0	0	0	0	C	516
<b>S518</b>	Scale factor for torque display	-	1 ... 9999	200	200	200	200	C	518
<b>S520</b>	Stator resistance <sup>(6)</sup> .	Ω	0.00 ... 99.99	3.20	1.48	1.20	1.20	C	520
<b>S525</b>	Rotor time constant <sup>(6)</sup> .	ms	0 ... 9999	255	98	155	155	C	525
<b>S526</b>	WTS. Parameter calculated by autotuning <sup>(6)</sup> .	-	0 ... 5000	2975	2368	3802	3802	C	526
<b>S527</b>	KM. Parameter calculated by autotuning <sup>(6)</sup> .	-	0 ... 16000	14110	14150	14920	14920	C	527
<b>S529</b>	Selection of PWM carrier frequency.	kHz	5 ... 16	5	5	5	5	C	529
<b>S530</b>	Kp for current loop <sup>(6)</sup> . Proportional gain for the PI current controller.	%	1 ... 9999	400	400	400	400	C	530
<b>S531</b>	Ki for current loop <sup>(6)</sup> . Integral action time for the PI current controller.	ms	1 ... 9999	10	10	10	10	C	531
<b>S532</b>	Kp for speed loop <sup>(6)</sup> . Proportional gain for the PI speed controller.	%	1 ... 9999	400	400	400	400	C	532
<b>S533</b>	Ki for speed loop <sup>(6)</sup> . Integral action time for the PI speed controller.	s	1 ... 9999	1.00	1.00	1.00	1.00	C	533



Par.	Description	MU	Range	Model default [kW]				PW	Modbus address
				0.75	1.5	2.2	2.3		
<b>S534</b>	Motor phase loss alarm sensitivity. Indicates the motor phase loss alarm sensitivity percentage <sup>(6)</sup> . <b>0</b> = Disabled; <b>100</b> = Maximum sensitivity.	%	0 ... 100	0	0	0	0	C	534
<b>S535</b>	Motor stall alarm sensitivity. Indicates the motor stall alarm sensitivity percentage <sup>(6)</sup> . <b>0</b> = Disabled; <b>100</b> = Maximum sensitivity.	%	0 ... 100	0	0	0	0	C	535
<b>INVERTER GROUP S6--</b>									
<b>S601</b>	Maximum current that the inverter can supply to the motor during its operation <sup>(7)</sup> .	A	0.1 ... 13.2(*)	5.0	9.4	13.2	13.2	R	601
<b>S602</b>	Undervoltage level. Voltage value under which the Undervoltage error is generated.	V	120 ... <b>S603</b>	200	200	200	200	R	602
<b>S603</b>	Overvoltage level. Voltage value over which the Overvoltage error is generated.	V	<b>S602</b> ... 450	420	420	420	420	R	603
<b>S605</b>	Board alarm temperature (CPU).	°C	50 ... 100	90	90	90	90	R	605
<b>S606</b>	Cooler alarm temperature.	°C	50 ... 100	90	90	90	90	R	606
<b>S607</b>	Enable PWM carrier derating. Enables derating with PWM carrier above 5 kHz. <b>0</b> = Disabled; <b>1</b> = Enabled.	-	0 ... 1	1	1	1	1	R	607
<b>S608</b>	Enable fans. <b>0</b> = Fans disabled; <b>1</b> = Fans enabled.	-	0 ... 1	1	1	1	1	R	608
(*) the maximum value in the range may change depending on the model (check with parameters manager).									
<b>ACCESS GROUP S9--</b>									
<b>S901</b>	Advanced passwords.	-	0 ... 9999	1259	1259	1259	1259	A	901
<b>S902</b>	Manufacturer password.	-	0 ... 9999	4783	4783	4783	4783	C	902
<b>S903</b>	Reserved password.	-	0 ... 9999	6278	6278	6278	6278	R	903
<b>NOTE:</b> The User level, where no password is required, is considered as Level 0 (U)									
<sup>(1)</sup> The minimum and maximum limits are calculated based on the number of pole pairs for the motor, between 5 and 100 Hz;									
<sup>(2)</sup> Looking at the motor with the shaft positioned to the front;									
<sup>(3)</sup> By combining two of the three inputs available, you can obtain 4 speed targets; See parameters <b>S304..S306</b> in paragraph " <b>8.1 TABLE OF CONFIGURATION PARAMETERS</b> " ON PAGE 22;									
<sup>(4)</sup> Parameter depends on the motor rating label data;									
<sup>(5)</sup> in alarm or emergency conditions, stoppage is always the free type;									
<sup>(6)</sup> If a firmware is updated to 05 or upper versions, the autotuning procedure must be repeated when the control is in vector mode ( <b>S103</b> = 2). The <b>S250</b> to <b>S533</b> parameters ( <b>S529</b> excluded) can thus be updated to the new calculation mode.									
<sup>(7)</sup> Parameter depends on the inverter model.									
<sup>(*)</sup> When changing the parameters, restart the inverter completely.									

## 8.2 Table of Modbus commands

The commands implemented are:

Command	Description
03	Read holding registers (16 registers maximum)
06	Write single holding register
16	Write multiple holding registers (16 registers maximum)

## 8.3 Serial communication settings

The **Compact** inverter communicates via serial according to the settings of parameter: **S404**.

## 8.4 Table of Modbus variables

Address	Parameter name	R/W	Description
980	Status word	R	<p>Read only, indicates the inverter operating status:</p> <p><b>Bit 0 = Ready</b>  <b>1</b> = Inverter ready to receive commands;  <b>0</b> = Inverter in alarm or not ready to receive commands;</p> <p><b>Bit 1 = Run</b>  <b>1</b> = Motor in motion;  <b>0</b> = Motor stopped;</p> <p><b>Bit 2 = Acc</b>  <b>1</b> = Motor in acceleration;  <b>0</b> = Motor not in acceleration;</p> <p><b>Bit 3 = Dec</b>  <b>1</b> = Motor in deceleration;  <b>0</b> = Motor not in deceleration;</p> <p><b>Bit 4 = Alarm</b>  <b>1</b> = Inverter in alarm;  <b>0</b> = Inverter not in alarm;</p> <p><b>Bit 5 = Overload</b>  <b>1</b> = Power exceeded 100%;  <b>0</b> = Power dropped below 100%;</p> <p><b>Bit 6 = Safe start</b>  <b>1</b> = Inverter in Safe start;  <b>0</b> = Inverter normal;</p> <p><b>Bit 7 = Motor rotation direction</b>  <b>1</b> = Forward;  <b>0</b> = Reverse;</p> <p><b>Bit 8 = Target</b>  <b>1</b> = Target speed reached;  <b>0</b> = Target speed not reached;</p> <p><b>Bit 9 = PWOFF</b>  <b>1</b> = Power-off;  <b>0</b> = Normal;</p> <p><b>Bit 10 = PWM derating</b>  <b>1</b> = Derating enabled;  <b>0</b> = Normal;</p> <p><b>Bit 14..Bit 15 = Parameter access level</b>  <b>00</b> = User;  <b>10</b> = Advanced;  <b>01</b> = Manufacturer;  <b>11</b> = Reserved.</p>

Address	Parameter name	R/W	Description
981	Alarm word	R	Read only, indicates active alarms: <b>Bit 0</b> = Undervoltage (UV); <b>Bit 1</b> = Overvoltage (OV); <b>Bit 2</b> = Overcurrent (OC); <b>Bit3</b> = Overload (OL); <b>Bit 4</b> = Device overtemperature (BT); <b>Bit 5</b> = Motor overtemperature (OT); <b>Bit 6</b> = Analogue input (AI); <b>Bit 7</b> = Data Eeprom (EP); <b>Bit 8</b> = Communication timeout (TO); <b>Bit 9</b> = User (US); <b>Bit 11</b> = Motor phase loss (PL); <b>Bit 12</b> = Motor thermal switch (MT); <b>Bit 13</b> = Motor stall (MS).
982	Target speed (rpm)	R	Target speed set for the motor (equal to monitor parameter "nr").
983	Motor frequency	R	Motor output frequency (equal to monitor parameter "fo").
984	Motor revolutions	R	Motor output speed (equal to monitor parameter "no").
985	Target speed (rpm)	R/W	Volatile target speed in rpm set for the motor.
986	Command word	R/W	Reading and writing, indicates the possible commands: <b>Bit 0</b> = Run <b>1</b> = Motor start command; <b>0</b> = No function;  <b>Bit 1</b> = Motor rotation direction <b>1</b> = Reverse; <b>0</b> = Forward.  <b>Bit 2</b> = Output 1 <b>1</b> = Enable output 1 (with parameter <b>S310</b> = 4); <b>0</b> = disable output 1;  <b>Bit 4</b> = Reset Alarms <b>1</b> = Reset active alarms; <b>0</b> = No function;  <b>Bit 5</b> = Default <b>1</b> = Restore default parameters; <b>0</b> = No function;  <b>Bit 6</b> = Saving <b>1</b> = Save parameters in Eeprom; <b>0</b> = No function;  <b>Bit 7</b> = Restart <b>1</b> = Full restart; <b>0</b> = No function;  <b>Bit 8</b> = Autotuning <b>1</b> = Start motor autotuning procedure; <b>0</b> = No function.
987	Password	R/W	Password for changing parameters at the desired level.
	Target speed (Hz/10)	R/W	Volatile target speed in frequency set for the motor.

## 8.5 Table of monitor data

Abbreviation	Description	R/W	Modbus address
<b>nr</b>	Target speed (rpm) Displays the target speed set for the motor.	R	1
<b>Fo</b>	Frequency (Hz) Displays the motor output frequency.	R	2
<b>Io</b>	RMS current (A) Displays the motor output RMS current.	R	3
<b>Vo</b>	Motor voltage (V) Displays the motor output voltage.	R	4
<b>no</b>	Revolutions (in rpm) Displays the motor output revolutions.	R	5
<b>T</b>	Torque (N) Displays the motor output torque.	R	6
<b>pf</b>	Power factor Displays the motor output power factor value.	R	7
<b>dir</b>	Rotation direction Displays the direction of the motor revolutions. <b>0</b> = Forward (clockwise); <b>1</b> = Reverse (anti-clockwise).	R	8
<b>Vdc</b>	DC bus voltage (V) Displays the DC bus voltage for the inverter board.	R	9
<b>Ti</b>	Device temperature (°C) Displays the temperature of the internal board.	R	10
<b>Te</b>	Cooler temperature (°C) Displays the temperature of the cooler.	R	11
<b>Ai</b>	Analogue input (V) Displays the voltage value of the signal from the potentiometer, if applicable.	R	12
<b>Di</b>	Digital input Displays the status of the digital inputs. <b>XXX</b> = I1 I2 I3 = 0/1 0/1 0/1.	R	13
<b>Do</b>	Digital output Displays the status of the Open/Closed relay, if applicable. <b>X</b> = 0/1.	R	14
<b>Pm</b>	Power (%) Displays an estimate for the mechanical power.	R	15
<b>Alm0</b>	Last alarm Displays the code for the last alarm that took place <sup>(1)</sup> .	R	16
<b>Alm1</b>	Penultimate alarm Displays the code for the penultimate alarm that took place <sup>(1)</sup> .	R	17
<b>Alm2</b>	Third last alarm Displays the code for the third last alarm that took place <sup>(1)</sup> .	R	18
<b>Ih</b>	Run time (h) Displays the total time for which the device has been on.	R	19
<b>Mh</b>	Motor run time (h) Displays the total time for which the motor has been running.	R	20

<sup>(1)</sup>See "Alarms" chapter for possible alarm codes shown after "**Alm0, Alm1, Alm2**"

## CHAPTER 9. ALARMS

The table below lists alarms with corresponding solutions. The main consequence of each alarm is that the device switches off.

### 9.1 Table of alarms

Code	Description	No. of red LED flashes	Cause	Alarm solution
<b>UV</b>	Undervoltage alarm	1	The voltage value of the device has dropped below the minimum value set via parameter <b>S602</b>	Reset alarm from governing input or automatically with the AUTORESET function when enabled
<b>OV</b>	Overvoltage alarm	2	The voltage value of the device has exceeded the maximum value set via parameter <b>S603</b>	
<b>OC</b>	Overcurrent alarm	3	The device has exceeded the maximum current value set via parameter <b>S601</b>	
<b>OL</b>	Overload alarm	4	When the amount of energy according to logic $I^2t$ exceeds the value set via parameters <b>S511</b> and <b>S512</b>	
<b>BT</b>	Circuit board overtemperature alarm	5	The device has reached and exceeded the maximum permitted temperature set via parameter <b>S605</b>	The alarm resets automatically when the device temperature drops to 10 °C (50 °F) below the temperature threshold set via parameter <b>S605</b>
<b>OT</b>	Cooler overtemperature alarm	6	The motor has reached and exceeded the maximum permitted temperature set via parameter <b>S606</b>	The alarm resets automatically when the motor temperature drops to 10 °C (50 °F) below the temperature threshold set via parameter <b>S606</b>
<b>AI</b>	Analogue input alarm	7	Hardware malfunction, cannot read the analogue input	Contact the manufacturer (the board needs to be repaired)
<b>EP</b>	Eeprom data alarm	8	The data structure is not intact	The default values are restored automatically. The parameters changed previously need to be re-entered manually.
<b>TO</b>	Communication timeout alarm	9	MODBUS communication interrupted	Check connection
<b>US</b>	User alarm	10	Alarm associated with an input	Remove the cause of the alarm
<b>PS</b>	Phase Lose alarm	12	<ul style="list-style-type: none"> <li>• Motor not connected correctly</li> <li>• Incorrect <b>S534</b> sensitivity</li> </ul>	<ul style="list-style-type: none"> <li>• Check the power supply wiring;</li> <li>• Change parameter <b>S534</b>.</li> </ul>
<b>MT</b>	Motor thermal switch alarm	13	Alarm associated with an input ( <b>S304...S306</b> = 17)	Remove the cause of the alarm
<b>MS</b>	Motor stall alarm	14	<ul style="list-style-type: none"> <li>• Motor does not rotate properly with vector algorithm;</li> <li>• Incorrect <b>S535</b> sensitivity.</li> </ul>	<ul style="list-style-type: none"> <li>• Make sure parameters <b>S500...S527</b> are correct;</li> <li>• Change parameter <b>S535</b>.</li> </ul>

## CHAPTER 10. PARAMETERS MANAGER

The **Compact** inverter can be configured using **Parameters Manager**, available to download from the website [www.evco.it](http://www.evco.it). To connect the inverter to a PC, an RS-485/USB converter must be used (p/n: **EVIF20SUXI**).

**NOTE:** For all necessary information on the subject, please refer to the instruction sheet p/n **104SUXIA104**

**NOTE:** Make sure you have downloaded the latest version of the drivers available for **Parameters Manager**.

Once you have started **Parameters Manager**, you need to configure the settings correctly to connect to **Compact**, as shown in the image below:

### ⚠ WARNING

#### MALFUNCTIONING OF THE EQUIPMENT

- Only update inverter parameters while the motor is off.
- Do not perform any communication serial port wiring procedures while the motor is on and the inverter powered.

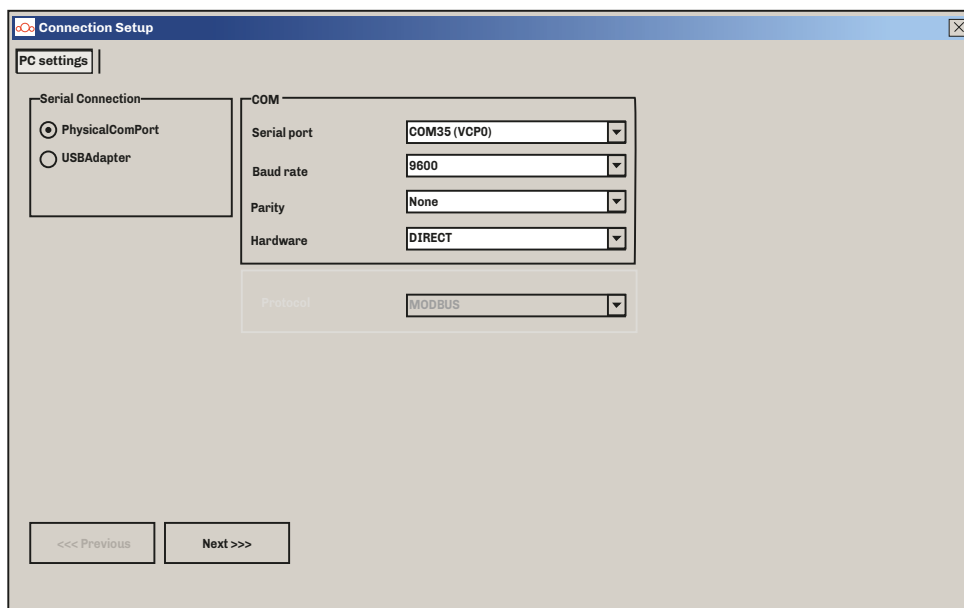

**Fig. 12.** Communication port setting

Press **NEXT** to continue and configure the network scan settings:

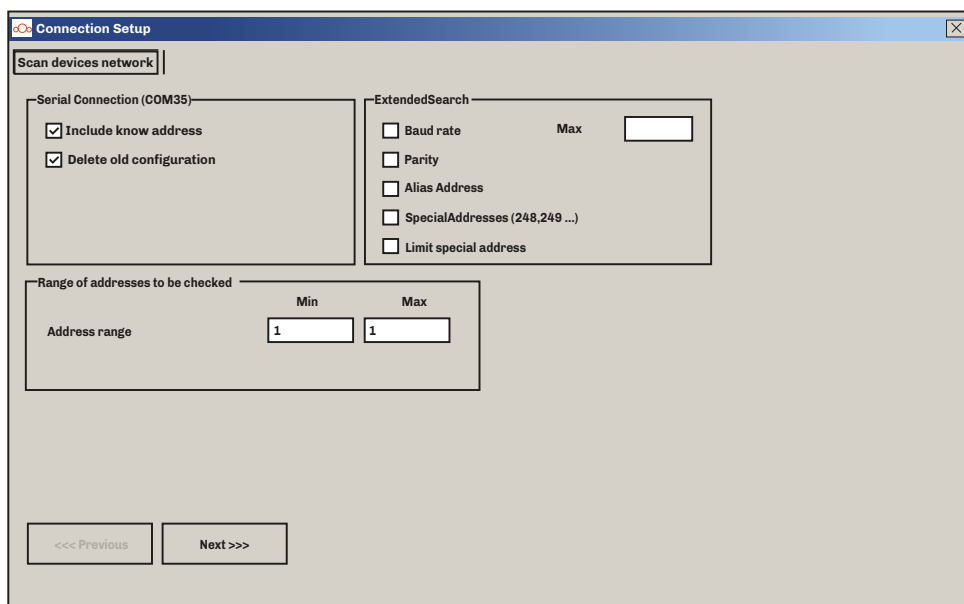

**Fig. 13.** Communication Modbus address setting

If **Parameters Manager** detects the **Compact** inverter, the following screen will appear, otherwise you will have to reconfigure the previous settings.

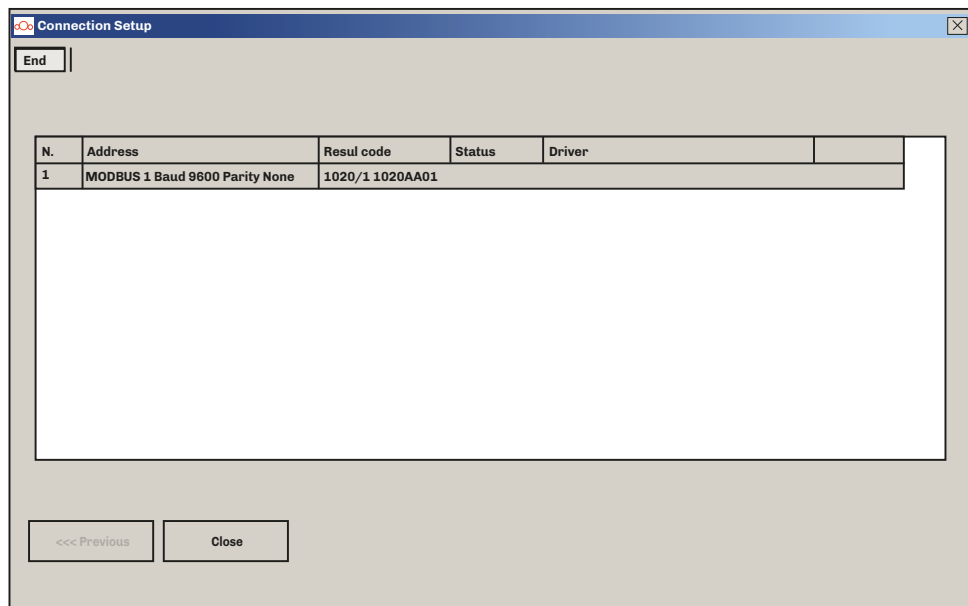

**Fig. 14. Compact Inverter detection**

Press **Close** to proceed with the **Compact** inverter parameter configuration screen.

---

## **CHAPTER 11. WARRANTY**

---

We recommend you read this document carefully; if you have any questions please contact EVCO directly.

EVCO guarantees its own products against material defects and/or manufacturing faults for a period of 24 months from the date of manufacture, or for a different period if specified by contractual norms.

The warranty is limited to product repair or, depending on the sole opinion of the manufacturer, replacement.

The warranty does not cover damage, malfunctioning, leaks or requests for compensation, due to:

- Operator error during use and/or installation;
- Modifications carried out by the purchaser;
- Unauthorised repairs;
- Dropping and/or damaging the device;
- Natural disasters (fires, lightning, floods, ...);
- Incorrect storage and/or maintenance.

It is the purchaser's responsibility to provide proof of the defect (and to request on-site assistance).



This page has been left blank on purpose.

**EVCO S.p.A.**

Via Feltre 81, 32036 Sedico (BL) ITALY

| **Telephone:** +39 0437 8422  
| **Fax:** +39 0437 83648  
| **email:** info@evco.it  
| **Web:** [www.evco.it](http://www.evco.it)

This document and the solutions contained within it are the intellectual property of EVCO, safeguarded by the Italian Industrial Property Code (CPI). EVCO forbids the reproduction and distribution, even in part, of the contents, unless express authorisation is obtained directly from EVCO. The customer (manufacturer, installer or end user) assumes all responsibility for device configuration. EVCO does not assume any responsibility for potential errors and reserves the right to make any changes, at any time, without the basic functional and safety-related features being affected.