

EV3 CHILL/HPRU & EVD CHILL/HPRU

Single and dual-circuit controllers
for chillers and heat pumps





Important

Read this manual carefully before installation and before using the devices and take all the prescribed precautions. Keep this manual with the devices for future consultation.

Only use the devices in the ways described in this manual. Do not use these devices as safety devices.



Disposal

The devices must be disposed of according to local regulations governing the collection of electrical and electronic waste.

SUMMARY

1	INTRODUCTION.....	5
1.1	Models available, purchasing codes and technical features	6
1.1.1	Controllers.....	6
1.1.2	Remote user interfaces.....	8
1.1.3	I/O expansions.....	10
2	DESCRIPTION	11
2.1	Description of EV3 CHILL/HPRU	11
2.2	Description of EVD CHILL/HPRU.....	12
2.3	Description of EV3K01	13
2.4	Description of EVJ LCD	14
2.5	Description of EVD094.....	15
3	MEASUREMENTS AND INSTALLATION.....	16
3.1	Measurements and installation of EV3 CHILL/HPRU	16
3.2	Measurements and installation of EVD CHILL/HPRU and EVD094	16
3.3	Measurements and installation of EV3K01.....	18
3.4	Measurements and installation of EVJ LCD	18
3.4.1	Models to be fitted to a panel.....	18
3.4.2	Models to be mounted on the wall.....	19
3.4.3	Models to be mounted on the wall with rear housing in a built-in box	20
3.5	ELECTRICAL CONNECTION.....	21
3.6	Description of EV3 CHILL/HPRU connectors.....	21
3.6.1	Example of EV3 CHILL/HPRU electrical connection	23
3.7	Description of EVD CHILL/HPRU connectors	24
3.7.1	Example of EVD CHILL/HPRU electrical connection	26
3.8	Description of EV3K01 connectors.....	27
3.8.1	Example of EV3K01 electrical connection	27
3.9	Description of EVJ LCD connectors	29
3.9.1	Models to be fitted to a panel.....	29
3.9.2	Models to be mounted on the wall.....	30
3.9.3	Models to be mounted on the wall with rear housing in a built-in box	33
3.10	Description of EVD094 connectors	35
3.10.1	Example of EVD094 electrical connection.....	36
3.11	Termination of the RS-485 line	37
4	DESCRIPTION OF USER INTERFACE	38
4.1	Key functions	38
4.2	Display	38
4.2.1	Icons	39
4.2.2	Signals.....	40
5	MENU.....	42
5.1	Access levels.....	42
5.2	Quick menus	42
5.3	Access to the main menu.....	42
5.4	List of menus	43
5.5	Alarm menu and Alarm history	44
5.6	Menu visibility	44
6	SELECTING THE OPERATING MODES.....	45
7	CONFIGURING A DEVICE	46
7.1	Parameters	46
7.2	Configuring inputs	60
7.2.1	Configuring input functions	60
7.2.2	Configuring universal type inputs.....	61
7.3	Configuring analogue outputs.....	62
7.3.1	Configuring type AO.....	62
7.3.2	Configuring AO function.....	64
7.4	Configuring triac and open collector outputs as analogue outputs	64

7.5	Configuring digital outputs	64
8	SERIAL PORTS	66
9	CONTROL FUNCTIONS	67
9.1	Initial information	67
9.2	Operating mode	67
9.3	Setting the control probe	67
9.4	Compressors	68
9.4.1	Initial information	68
9.4.2	Single circuit controls	70
9.4.3	Dual-circuit controls	74
9.4.4	Remote control	81
9.4.5	Oil recovery	81
9.4.6	Dynamic setpoint	82
9.4.7	Solenoid valve	83
9.5	Hot gas bypass	83
9.6	System pump	84
9.6.1	Initial information	84
9.6.2	Operation	84
9.6.3	ON/OFF operation	84
9.6.4	Modulating operation	85
9.6.5	Antifreeze operation	85
9.7	System electrical heating elements	85
9.7.1	Initial information	85
9.7.2	Heating elements in antifreeze mode	86
10	Ventilation Control	87
10.1	Initial information	87
10.2	Step control function	87
10.3	Modulating control function	88
10.4	Capacity control during defrosting	88
11	Defrost	89
11.1	Initial information	89
11.1.1	Start defrost control	89
11.2	End defrost control	89
12	DOMESTIC HOT WATER (DHW)	91
12.1	Initial information	91
12.2	Anti-legionella function	92
12.3	Boiler electric heating elements	92
12.4	Solar Panels	93
13	INTERNAL STATUSES	94
14	ALARMS	97
15	ACCESSORIES	101
15.1	INTRABUS/RS-485 interface and EVIF22ISX programming key	101
15.1.1	USING IT AS AN INTRABUS - RS485 INTERFACE	101
1.	Place all the micro-switches of the two- and three-way DIP switch in the OFF position. Note: In this condition the interface communicates with a fixed baud rate (the last valid one). Should it be necessary to modify the baud rate to ensure the communication rate please set the micro-switch number 3 of the three-way DIP switch in ON position. This way the interface will start a network scan to identify the correct baud rate (see interface instruction sheet for more information)	101
15.1.2	Using it as a programming key	102
15.2	RS-485/USB EVIF20SUXI serial interface	103
15.3	0025100010 drip protector	103
15.4	CJAV connection kit (connectors to wire up the devices)	104
16	TECHNICAL SPECIFICATIONS	105
16.1	Technical specifications EV3 CHILL/HPRU	105
16.2	EVD CHILL/HPRU technical specifications	107

1 INTRODUCTION

EV3 CHILL/HPRU and EVD CHILL/HPRU are controllers for single and dual-circuit air-water and water-water chillers and heat pumps with up to 6 compressors. EV3 CHILL/HPRU is available in the standard 74 x 32 mm format with a built-in user interface consisting of a two-line LED display (with decimal point and function icons) and four touch keys. It guarantees IP65 protection and is easy to clean. The power supply voltage is 12 VAC and the controller is installed on a panel with snap-in brackets.

EVD CHILL/HPRU, on the other hand, is available in the standard 4-module DIN format, in a blind version or with a two-line LED display. The power supply voltage is 115... 230 VAC and the controller is designed to be installed on a DIN rail inside an electric box.

Two different remote user interfaces are available for both the controllers: EV3K01 (available in the standard 74 x 32 mm format consisting of a two-line LED display, four touch keys and panel installation) and EVJ LCD (in the 111 x 76 mm format consisting of a static two-line LCD display, six touch keys and panel or wall installation).

When control is based on evaporating pressure rather than condensing pressure, it is possible to control condensing units (refrigeration) or dry cooler units. It is also possible to configure the controllers to respond to (up to 6) digital commands, rather than an analogue command from a remote master unit.

These controllers are capable of running compressors and fans of both the on-off and modulating types.

1.1 Models available, purchasing codes and technical features

1.1.1 Controllers

The table below shows the models available, the purchasing codes and the technical features of the controllers.

	EV3 CHILL		EVD CHILL			EV3 HPRU		EVD HPRU		
Dimensions										
74 x 32 mm	•	•				•	•			
4 DIN modules			•	•	•			•	•	•
User interface										
Blind version			•	•				•	•	
Two-line LED display + 4 capacitive keys	•	•				•	•			
Two-line LED display + 6 keys					•					•
Installation										
Panel-mounted	•	•				•	•			
In a control panel			•	•	•			•	•	•
Connections										
Micro-Fit connectors	•	•	•	•	•	•	•	•	•	•
Edge connectors	•	•				•	•			
Plug-in screw terminal blocks	•	•	•	•	•	•	•	•	•	•
Power supply										
12 VAC not insulated	•	•				•	•			
115... 230 VAC insulated			•	•	•			•	•	•
Configurable inputs										
NTC or dry contact	5	5	5	5	5	5	5	5	5	5
NTC/4-20 mA/0-5 V/0-10 or dry contact	2	2	2	2	2	2	2	2	2	2
Digital inputs										
Dry contact/pulse	2	2	2	2	2	2	2	2	2	2
Dry contact	1	1	1	1	1	1	1	1	1	1
Analogue outputs										
0-10 V/PWM/phase cut	2	2	2	2	2	2	2	2	2	2
Digital outputs (electro-mechanical relays; A res. @ 250 VAC)										
2 A SPST	4	4				4	4			
3 A SPST			2	2	2			2	2	2
8 A SPDT			1	1	1			1	1	1
12 A SPST			1	1	1			1	1	1
Digital outputs (triac; A res. @ 250 VAC)										
200 mA		1					1			
2 A		1					1			
Digital outputs (open collector)										
12 VDC, max. 40 mA			1	1	1			1	1	1

Communications ports										
INTRABUS	1	1	1	1	1	1	1	1	1	1
RS-485		1		1	1		1		1	1
Other features										
Clock		•		•	•		•		•	•
Alarm buzzer	•	•			•	•	•			•
Purchasing codes										
Purchasing code ⁽¹⁾	(a)	(b)	(c)	(d)	(e)	(f)	(g)	(h)	(i)	(j)

- ⁽¹⁾ Purchasing code:
- (a) EV3904LM2 (EV3904LM2GF with RS-485 communication port and real time clock)
 - (b) EV3906LM2GF
 - (c) EVD904BM9
 - (d) EVD904BM9MF
 - (e) EVD904LM9MF
 - (f) EV3914LM2 (EV3914LM2GF with RS-485 communication port and real time clock)
 - (g) EV3916LM2GF
 - (h) EVD914BM9
 - (i) EVD914BM9MF
 - (j) EVD914LM9MF

The connectors (connection kits) for cabling the controllers must be ordered separately. The table below shows the purchasing code of each controller and its connector code.

Device purchasing code	Connection kit purchasing code
EV3904LM2	CJAV37
EV3906LM2GF	CJAV39
EVD904BM9	CJAV38
EVD904BM9MF	CJAV38
EVD904LM9MF	CJAV38
EV3904LM2	CJAV37
EV3906LM2GF	CJAV39
EVD904BM9	CJAV38
EVD904BM9MF	CJAV38
EVD904LM9MF	CJAV38

1.1.2 Remote user interfaces

The table below shows the models, purchasing codes and technical features of the EV3K01 remote user interfaces.

Dimensions	
74 x 32 mm	•
User interface	
Two-line LED display + 4 capacitive keys	•
Installation	
Panel-mounted	•
Connections	
Plug-in screw terminal blocks	•
Power supply	
12 VAC/DC not insulated	•
Communications ports	
INTRABUS	•
Other features	
Alarm buzzer	•
Purchasing codes	
Purchasing code	EV3K01X0CT

The table below shows the models, purchasing codes and technical features of the EVJ LCD remote user interfaces.

Dimensions					
111.4 x 76.4 mm	•	•	•	•	•
User interface					
Static two-line LCD display + 6 capacitive keys	•	•	•	•	•
Installation					
Panel-mounted	•				
Wall-mounted		•	•		
Wall mounting with rear housing in a built-in box				•	•
Connections					
Fixed screw terminal blocks		•	•	•	•
Plug-in screw terminal blocks	•				
Power supply					
12 VAC/DC not insulated	•	•	•		
115... 230 VAC insulated				•	•
Communications ports					
INTRABUS	•		•	•	•
RS-485 INTRABUS		•			
Other features					
Alarm buzzer	•	•	•	•	•
Purchasing codes					
Purchasing code	EVJD900N2	EVJD900N2VW	EVJD900N2VWTX	EVJD900N7VP	EVJD902N9VP

1.1.3 I/O expansions

The table below shows the models, purchasing codes and technical features of the EVD094 I/O expansions.

Format	
4 DIN modules	•
User interface	
Blind version	•
Installation	
Inside an electric box	•
Connections	
Micro-Fit connectors	•
Plug-in screw terminal blocks	•
Power supply	
115... 230 VAC insulated	•
Configurable inputs	
NTC or dry contact	5
NTC/4-20 mA/0-5 V/0-10 V or dry contact	2
Digital inputs	
Dry contact	3
Analogue outputs	
0-10 V/PWM/phase cut	2
Digital outputs (electro-mechanical relays; A res. @ 250 VAC)	
3A SPST	2
8A SPDT	1
12A SPST	1
Digital outputs (open collector)	
12 VDC, max. 40 mA	1
Communications ports	
INTRABUS	1
Purchasing codes	
Purchasing code	EVD094EM9

The connectors (connection kits) for cabling the I/O expansions must be ordered separately. The table below shows the purchasing code of the expansion and its connector code.

Device purchasing code	Connection kit purchasing code
EVD094EM9	CJAV38

2 DESCRIPTION

The following paragraphs describe the various devices that can be used to control chiller and heat pump units.

2.1 Description of EV3 CHILL/HPRU

The drawing below shows the layout of the EV3 CHILL/HPRU.

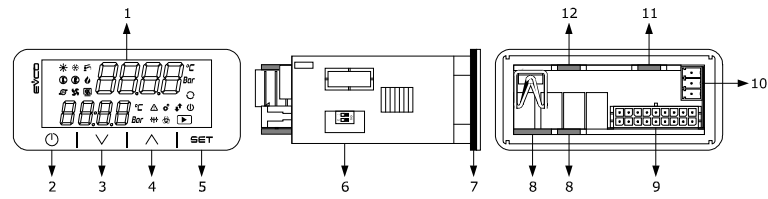

The table below describes each part of the EV3 CHILL/HPRU.

Part	Description
1	display
2	on/off key (subsequently also called the "on/stand-by key")
3	decrease key (subsequently also called the "down key")
4	increase key (subsequently also called the "up key")
5	setting key (subsequently also called the "set key")
6	micro-switch for the termination resistor of the RS-485 MODBUS line
7	seal
8	edge connector joint for cabling electro-mechanical relay digital outputs (for future reference, digital outputs DO1... DO4)
9	male Micro-Fit connector for cabling the power supply, analogue inputs, digital inputs, analogue outputs and the INTRABUS port
10	plug-in screw terminal block, male only, for cabling the RS-485 MODBUS port
11	edge connector joint for cabling the triac output (for future reference, output TK1)
12	edge connector joint for cabling the triac output (for future reference, output TK2)

The table gives the maximum provided.

2.2 Description of EVD CHILL/HPRU

The diagram below shows the layout of the EVD CHILL/HPRU.

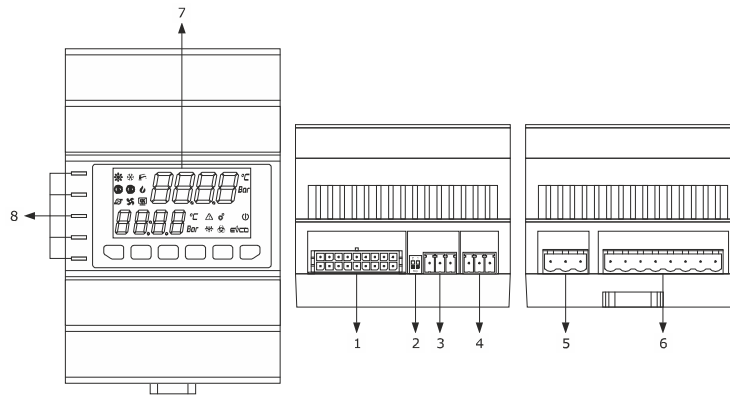

The table below describes each part of the EVD CHILL/HPRU.

Part	Description
1	male Micro-Fit connector for cabling analogue inputs, digital inputs, analogue outputs and the open collector digital output (for future reference, digital output OC1)
2	micro-switch for the termination resistor of the RS-485 MODBUS line
3	plug-in screw terminal block, male only, for cabling the RS-485 MODBUS port
4	plug-in screw terminal block, male only, for cabling the INTRABUS port
5	plug-in screw terminal block, male only, for cabling the digital outputs with electro-mechanical relay (for future reference, digital outputs DO1 and DO2)
6	plug-in screw terminal block, male only, for cabling the power supply, electrical-mechanical relay digital outputs (for future reference, digital outputs DO3 and DO4)
7	user interface (not available in the blind versions)
8	signalling LEDs

2.3 Description of EV3K01

The diagram below shows the layout of the EV3K01.

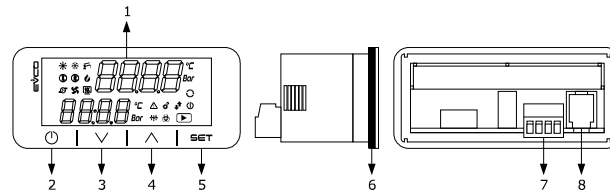

The table below describes each part of the EV3 CHILL/HPRU.

Part	Description
1	display
2	on/off key (subsequently also called the "on/stand-by key")
3	decrease key (subsequently also called the "down key")
4	increase key (subsequently also called the "up key")
5	setting key (subsequently also called the "set key")
6	seal
7	screw terminal block for cabling the power supply and the INTRABUS port
8	not used

2.4 Description of EVJ LCD

The diagram below shows the layout of the EVJ LCD.

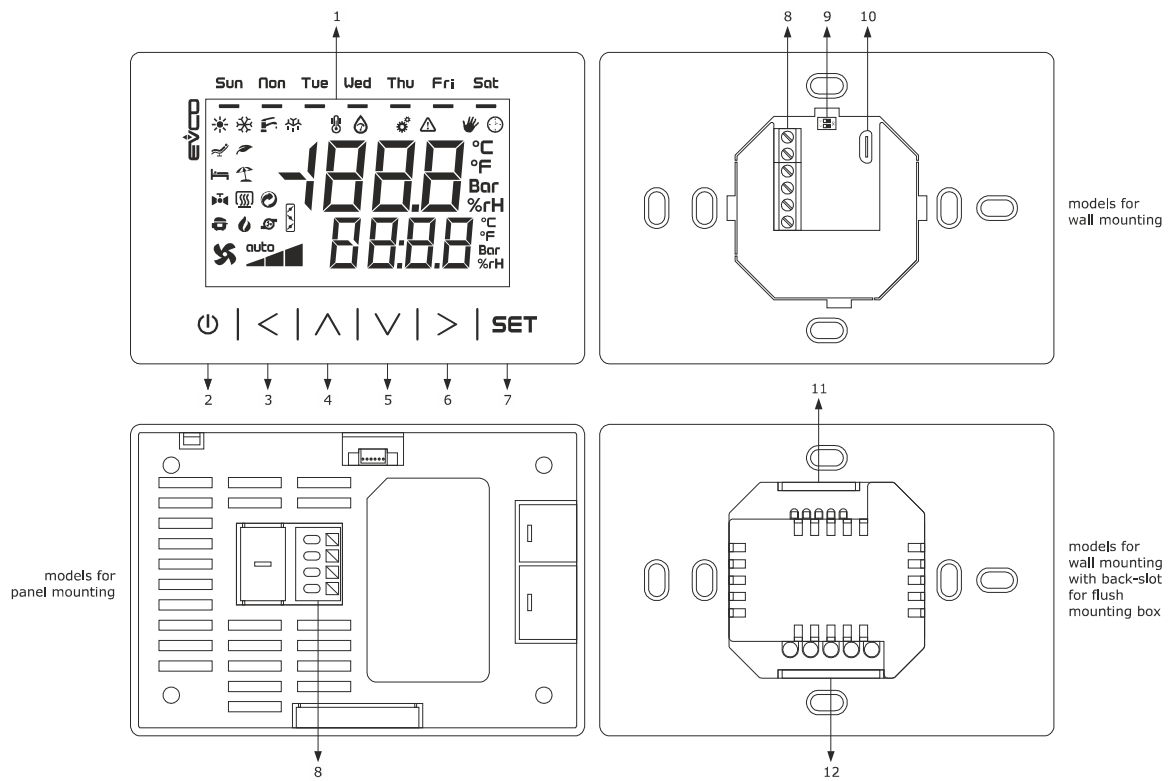

The table below describes each part of the EVJ LCD.

Part	Description
1	display
2	on/off key (subsequently also called the "on/stand-by key")
3	left key (subsequently also called "left")
4	increase key (subsequently also called the "up key")
5	decrease key (subsequently also called the "down key")
6	right key (subsequently also called "right")
7	setting key (subsequently also called the "set key")
8	screw terminal block for cabling the power supply and the INTRABUS port
9	- micro-switch for the termination resistor of the RS-485 INTRABUS line on the EVJD900N2VWTX model - not fitted otherwise
10	not used
11	screw terminal block for cabling the analogue inputs and the INTRABUS port
12	screw terminal block for cabling the power supply

2.5 Description of EVD094

The diagram below shows the layout of the EVD094.

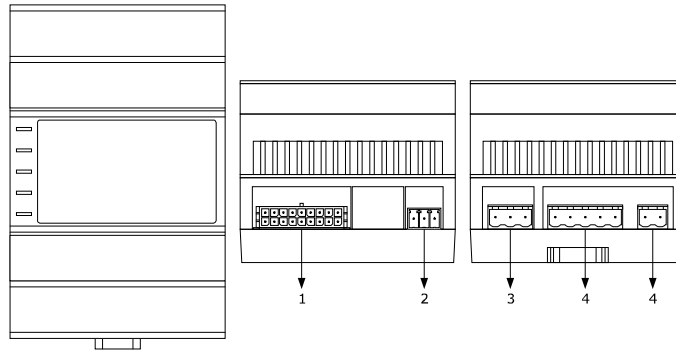

The table below describes each part of the EVD094.

Part	Description
1	male Micro-Fit connector for cabling analogue inputs, digital inputs, analogue outputs and the open collector digital output (for future reference, digital output OC1)
2	plug-in screw terminal block, male only, for cabling the INTRABUS port
3	plug-in screw terminal block, male only, for cabling the digital outputs with electro-mechanical relay (for future reference, digital outputs DO1 and DO2)
4	plug-in screw terminal block, male only, for cabling the power supply, electrical-mechanical relay digital outputs (for future reference, digital outputs DO3 and DO4)

3 MEASUREMENTS AND INSTALLATION

3.1 Measurements and installation of EV3 CHILL/HPRU

The diagram below shows the measurements of EV3 CHILL/HPRU; measurements are expressed in mm (inches).

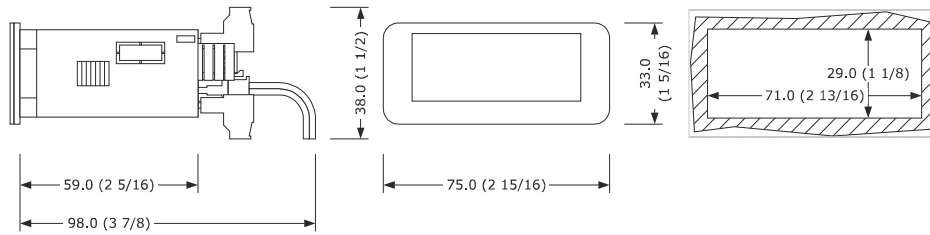

Installation is on a panel with the snap-in brackets provided.

The thickness of the panel must be between 0.8 and 2.0 mm (0.031 and 0.078 in).

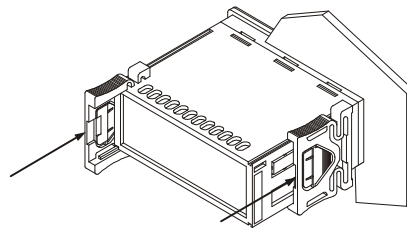

3.2 Measurements and installation of EVD CHILL/HPRU and EVD094

The diagram below shows the measurements of EVD CHILL/HPRU and EVD094 (4 DIN modules); measurements are expressed in mm (inches).

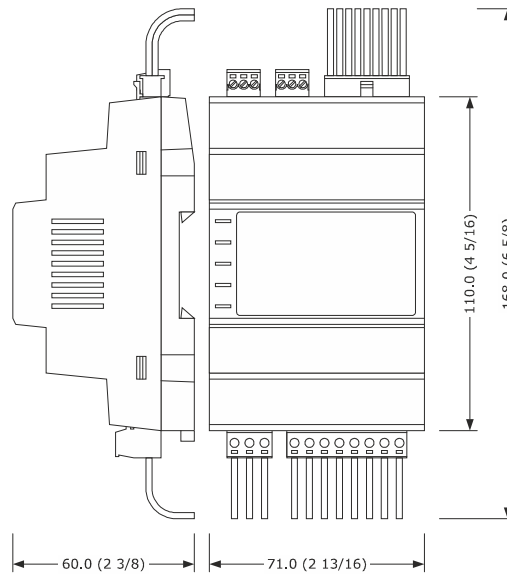

Installation is on a DIN rail 35.0 x 7.5 mm (1 3/8 x 5/16 in) or 35.0 x 15.0 mm (1 3/8 x 9/16 in) in a control panel.

The diagrams below show how to install EVD CHILL/HPRU and EVD094.

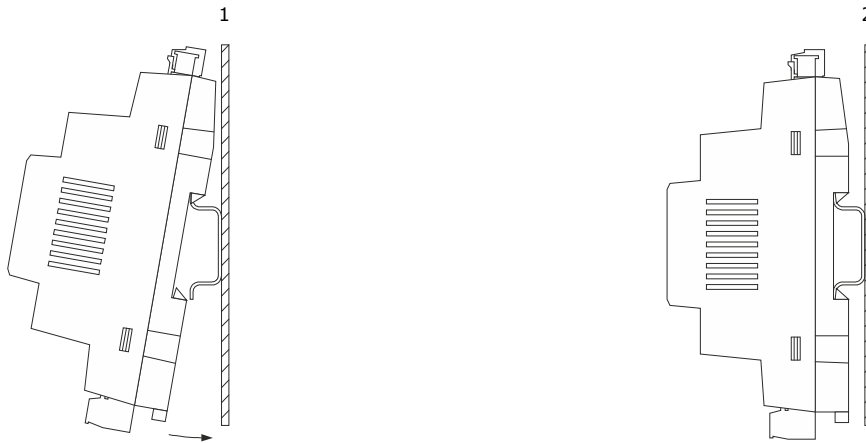

To remove EVD CHILL/HPRU and EVD094, first remove any plug-in screw terminal blocks fitted in the lower part, then, using a screwdriver, loosen the DIN rail clip as shown in the diagrams below.

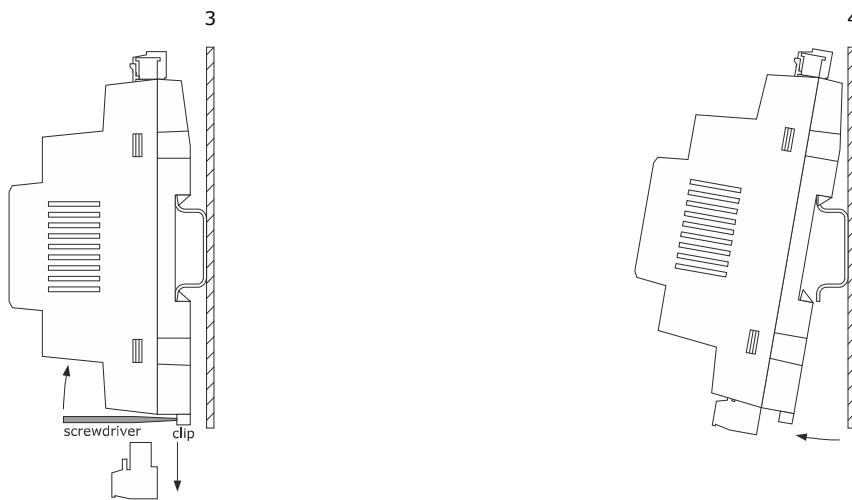

To re-install EVD CHILL/HPRU and EVD094, first press the DIN rail clip fully in.

3.3 Measurements and installation of EV3K01

The diagram below shows the measurements of EV3K01; measurements are expressed in mm (inches).

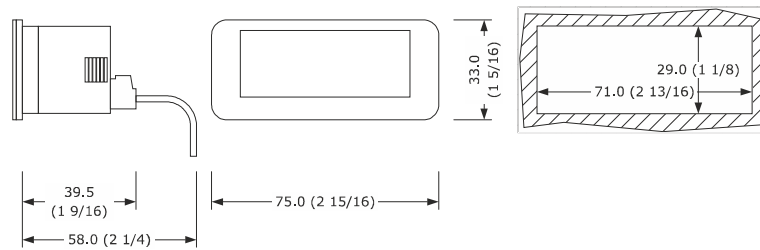

Installation is on a panel with the snap-in brackets provided.

The thickness of the panel must be between 0.8 and 2.0 mm (1/32 and 1/16 in).

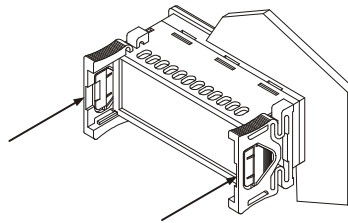

3.4 Measurements and installation of EVJ LCD

3.4.1 Models to be fitted to a panel

The diagram below shows the measurements of the EVJ LCD models for panel installation; measurements are expressed in mm (inches).

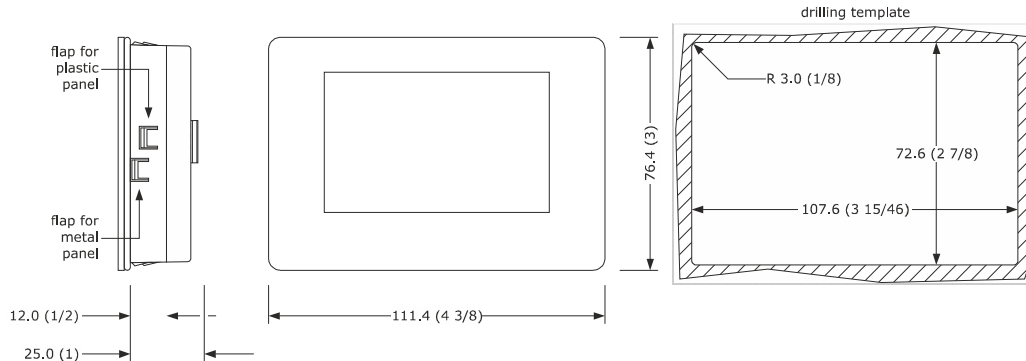

Installation is on a panel with elastic holding flaps.

The metal panel must be between 0.8 and 1.5 mm (1/32 and 1/16 in) thick, while the plastic panel must be between 0.8 and 3.4 mm (1/32 and 1/8 in).

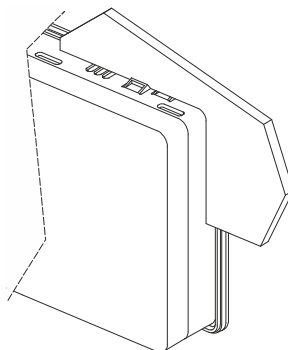

3.4.2 Models to be mounted on the wall

The diagram below shows the measurements of the EVJ LCD models for wall installation; measurements are expressed in mm (inches).

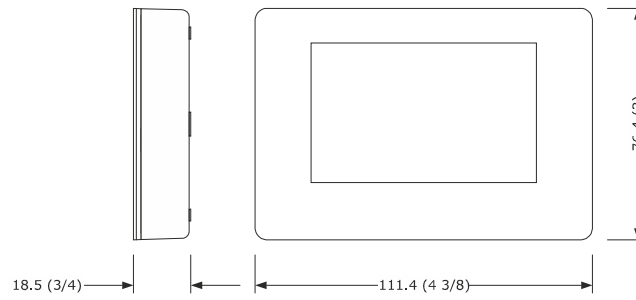

Installation is on the wall (with fixing screws and plugs) or in regular built-in boxes (with fixing screws).

1. Disengage the back cover from the front and the housing using a screwdriver.
- 2.1 Wall installation:
 - 2.1.1 Rest the back cover on the wall in a place that allows the connection cables to be fed through the opening.
 - 2.1.2 Use the slots in the back cover as a guide for drilling the 4 holes with a diameter suitable for the plug. We recommend using 5 mm (3/16 inch) diameter plugs.
 - 2.1.3 Insert the plugs into the holes drilled in the wall.
 - 2.1.4 Fit the back cover to the wall with 4 screws. We recommend using flat countersunk screws.
- 2.2 Installation in a built-in box: fit the back cover to the box with 4 screws. We recommend using flat countersunk screws.
3. Make the electrical connection as shown in the section ELECTRICAL CONNECTION, without powering up the device.
4. Fit the front of the device to the back cover.

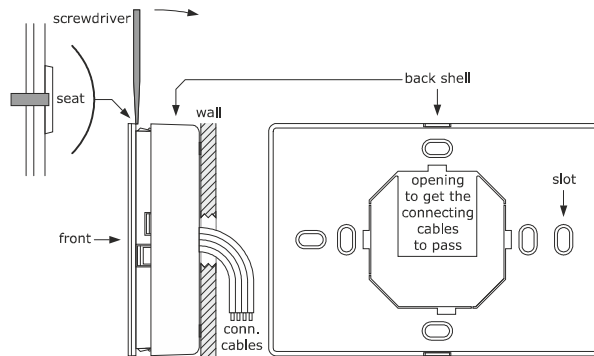

3.4.3 Models to be mounted on the wall with rear housing in a built-in box

The diagram below shows the measurements of the EVJ LCD models for wall installation with rear housing in a built-in box; measurements are expressed in mm (inches).

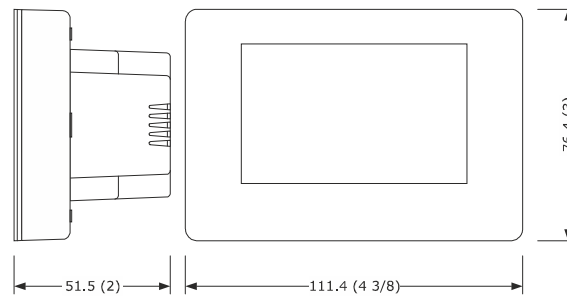

Installation is in regular built-in boxes with fixing screws.

1. Disengage the back cover from the front and the housing using a screwdriver.
2. Fit the back cover to the box with 4 screws.
We recommend using flat countersunk screws.
3. Make the electrical connection as shown in the section ELECTRICAL CONNECTION, without powering up the device.
4. Fit the front of the device to the back cover.

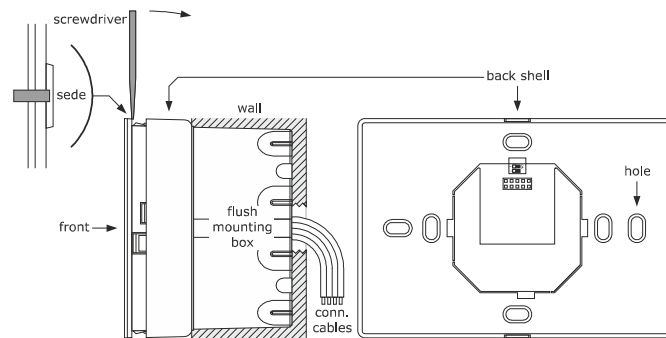

INSTALLATION PRECAUTIONS

- ensure that the working conditions are within the limits stated in the TECHNICAL SPECIFICATIONS section
- do not install the device close to heat sources, equipment with a strong magnetic field, in places subject to direct sunlight, rain, damp, excessive dust, mechanical vibrations or shocks
- in compliance with safety regulations, the device must be installed properly to ensure adequate protection from contact with electrical parts. All protective parts must be fixed in such a way as to need the aid of a tool to remove them

3.5 ELECTRICAL CONNECTION

	<p>N.B.</p> <ul style="list-style-type: none"> - use cables of an adequate section for the current running through them - to reduce any electromagnetic interference, locate the power cables as far away as possible from the signal cables and connect to a INTRABUS and/or RS-485 network using a screened cable with a twisted pair for the signal and an independent third wire for connecting the reference (GND); the shield (braid) is earthed at a single point to avoid parasitic currents (a BELDEN 3106A cable or equivalent is recommended)
---	--

3.6 Description of EV3 CHILL/HPRU connectors

The diagram below shows the layout of the EV3 CHILL/HPRU connectors.

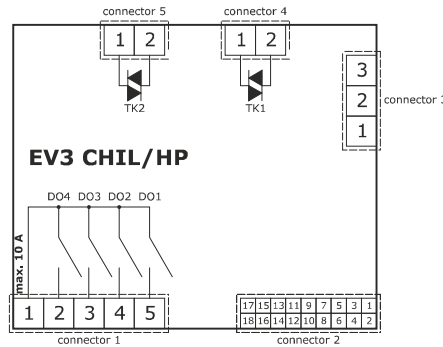

The tables below describe the EV3 CHILL/HPRU connectors. The tables give the maximum provided.

Connector 1

Part	Description
1	electro-mechanical relay digital outputs DO1... DO4 (max. 10 A): common
2	electro-mechanical relay digital output DO4 (2A SPST): normally open
3	electro-mechanical relay digital output DO3 (2A SPST): normally open
4	electro-mechanical relay digital output DO2 (2A SPST): normally open
5	electro-mechanical relay digital output DO1 (2A SPST): normally open

Connector 2

Part	Description
1	analogue input IN6 (NTC or dry contact)
2	analogue input IN1 (NTC/4-20 mA/0-5 V/0-10 V or dry contact)
3	analogue input IN7 (NTC or dry contact)
4	analogue input IN2 (NTC/4-20 mA/0-5 V/0-10 V or dry contact)
5	dry contact digital input pulse IN8
6	analogue input IN3 (NTC or dry contact)
7	dry contact digital input pulse IN9
8	analogue input IN4 (NTC or dry contact)
9	dry contact digital input IN10
10	analogue input IN5 (NTC or dry contact)
11	analogue output AO1 (0-10V/PWM/phase cut)

Part	Description
12	reference (GND)
13	analogue output AO2 (0-10V/PWM/phase cut)
14	INTRABUS port signal
15	auxiliary power supply output 12 VDC, max. 100 mA
16	reference (GND)
17	EV3 CHILL/HPRU power supply (12 VAC not insulated)
18	EV3 CHILL/HPRU power supply (12 VAC not insulated)

Connector 3

Part	Description
1	positive signal RS-485 MODBUS port
2	negative signal RS-485 MODBUS port
3	reference (GND)

Connector 4

Part	Description
1	Triac TK1 output: common
2	Triac TK1 output (200 mA): normally open

Connector 5

Part	Description
1	Triac TK2 output: common
2	Triac TK2 output (2 A): normally open

3.6.1 Example of EV3 CHILL/HPRU electrical connection

The diagram below shows an example of the EV3 CHILL/HPRU electrical connection with Triac (optional) and RS-485 communication port (optional).

	<p>N.B.</p> <ul style="list-style-type: none"> - do not power another device with the same transformer - protect the power supply with a 1 A-T 250 VAC fuse
---	--

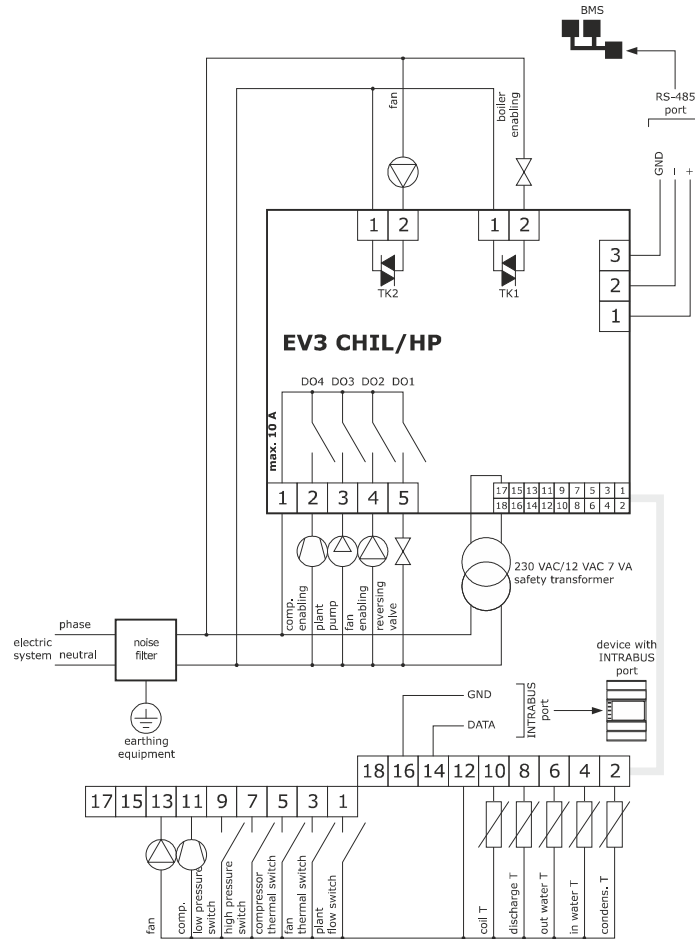

3.7 Description of EVD CHILL/HPRU connectors

The diagram below shows the layout of the EVD CHILL/HPRU connectors.

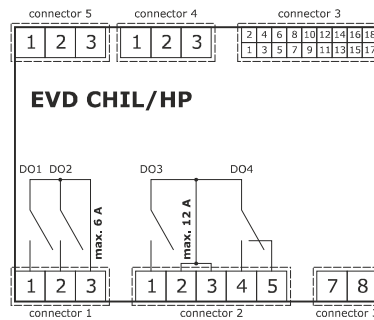

The tables below describe the EVD CHILL/HPRU connectors.

Connector 1

Part	Description
1	electro-mechanical relay digital output DO1 (3A SPST): normally open
2	electro-mechanical relay digital output DO2 (3A SPST): normally open
3	electro-mechanical relay digital outputs DO1... DO4 (max. 6 A): common

Connector 2

Part	Description
1	electro-mechanical relay digital output DO3 (12A SPST): normally open
2	electro-mechanical relay digital outputs DO3... DO4 (max. 12 A): common
3	electro-mechanical relay digital outputs DO3... DO4 (max. 12 A): common
4	electro-mechanical relay digital output DO4 (8A SPDT): normally open
5	electro-mechanical relay digital output DO4: normally open
7	EVD CHILL/HPRU power supply (115... 230 VAC insulated)
8	EVD CHILL/HPRU power supply (115... 230 VAC insulated)

Connector 3

Part	Description
1	analogue output AO2 (0-10 V/PWM/phase cut)
2	analogue output AO1 (0-10 V/PWM/phase cut)
3	reference (GND)
4	analogue input IN1 (NTC/4-20 mA/0-5 V/0-10 V or dry contact)
5	analogue input IN10 (NTC or dry contact)
6	analogue input IN2 (NTC/4-20 mA/0-5 V/0-10 V or dry contact)
7	analogue input IN9 (NTC or dry contact)
8	analogue input IN3 (NTC or dry contact)
9	dry contact digital input pulse IN8
10	analogue input IN4 (NTC or dry contact)
11	dry contact digital input pulse IN7

12	analogue input IN5 (NTC or dry contact)
13	reference (GND)
14	dry contact digital input IN6
15	ratiometric analogue inputs power supply (5VDC, max 40 mA)
16	auxiliary power supply output 12 VDC, max. 40 mA
17	open collector digital output OC1 (12 V, max. 40 mA)
18	reference (GND)

Connector 4

Part	Description
1	reference (GND)
2	negative signal RS-485 MODBUS port
3	positive signal RS-485 MODBUS port

Connector 5

Part	Description
1	INTRABUS port reference (GND)
2	INTRABUS port signal
3	12 VDC output

3.7.1 Example of EVD CHILL/HPRU electrical connection

The diagram below shows an example of the EV3 CHILL/HPRU electrical connection.

	<p>N.B. Protect the power supply with a 1 A-T 250 VAC fuse</p>
---	--

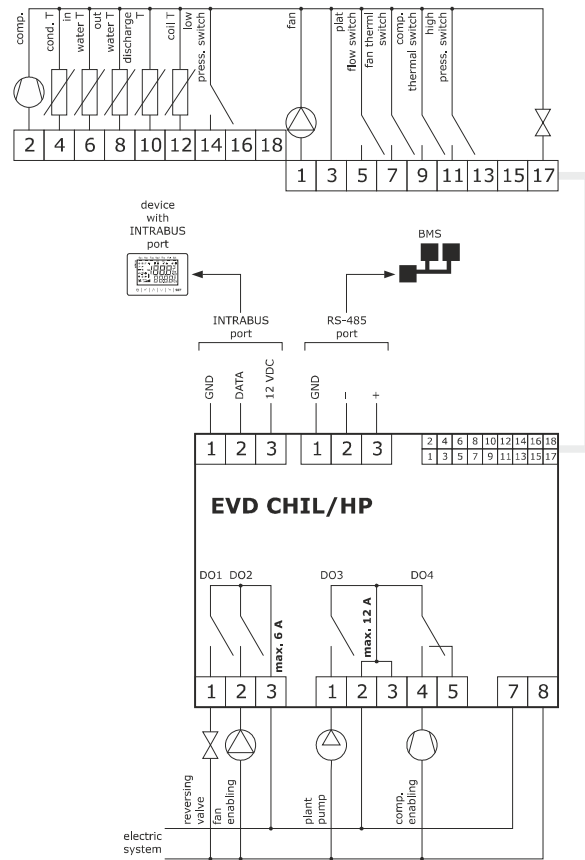

3.8 Description of EV3K01 connectors

The diagram below shows the layout of the EV3K01 connectors.

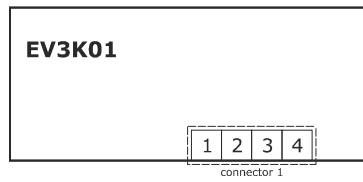

The tables below describe the EV3K01 connectors.

Connector 1

Part	Description
1	EV3K01 power supply (12 VAC/DC not insulated); if the device is powered by direct current, connect the positive terminal
2	for EVCO use only
3	INTRABUS port signal
4	reference (GND) power supply and INTRABUS port

3.8.1 Example of EV3K01 electrical connection

The diagram below shows an example of the EV3K01 electrical connection. In the example EV3K01 has an independent power source.

	<p>N.B.</p> <ul style="list-style-type: none"> - do not power another device with the same transformer - the maximum permitted length for connection cables of the INTRABUS port is 30 m (98.4 ft)
--	--

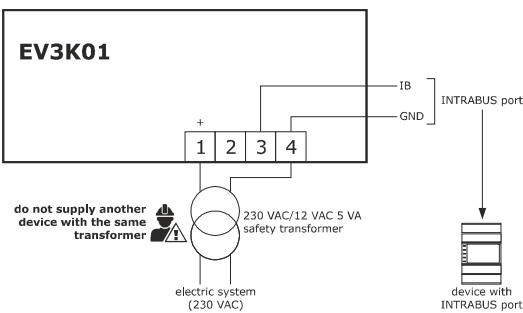

The diagram below shows an example of the EV3K01 electrical connection. In the example EV3K01 is powered by an EVD CHILL/HPRU controller.

	<p>N.B.</p> <ul style="list-style-type: none"> - EV3K01 must not be powered with an EV3 CHILL/HPRU controller - the maximum permitted length for connection cables of the INTRABUS port is 10 m (32.8 ft)
---	--

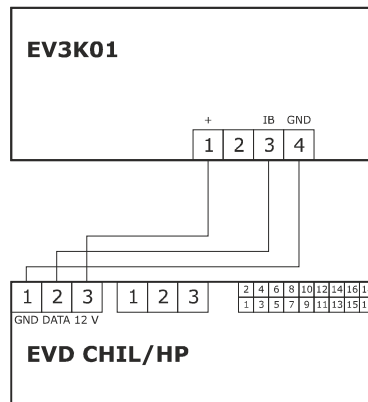

3.9 Description of EVJ LCD connectors

3.9.1 Models to be fitted to a panel

The diagram below shows the layout of the EVJ LCD connectors for panel installation.

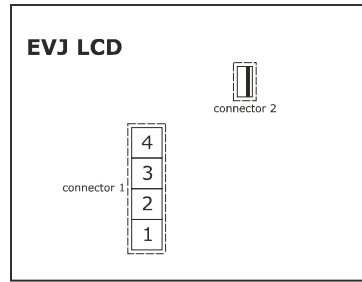

The tables below describe the EVJ LCD connectors for panel installation.

Connector 1

Part	Description
1	INTRABUS port reference (GND)
2	INTRABUS port signal
3	EVJ LCD power supply (12 VAC/DC not insulated); if the device is powered by direct current, connect the negative terminal
4	EVJ LCD power supply (12 VAC/DC not insulated); if the device is powered by direct current, connect the negative terminal

Connector 2

For EVCO use only.

3.9.1.1 Example of electrical connection of EVJ LCD models for panel installation

The diagram below shows an example of the connection of the EVJ LCD models for panel installation. In the example EVJ LCD has an independent power source.

	<p>N.B.</p> <ul style="list-style-type: none"> - do not power another device with the same transformer - the maximum permitted length for connection cables of the INTRABUS port is 30 m (98.4 ft)
--	--

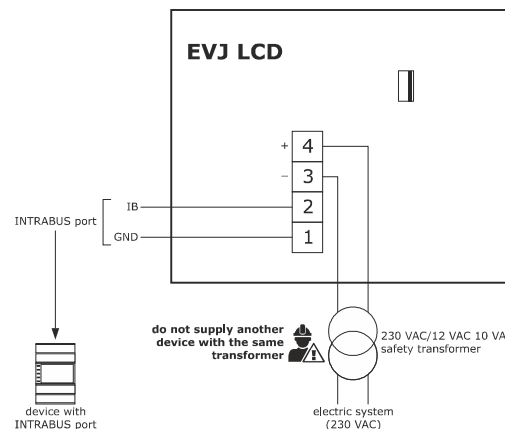

The diagram below shows an example of the connection of the EVJ LCD models for panel installation. In the example EVJ LCD is powered by an EVD CHILL/HPRU controller.

	<p>N.B.</p> <ul style="list-style-type: none"> - EVJ LCD must not be powered with an EV3 CHILL/HPRU controller - the maximum permitted length for connection cables of the INTRABUS port is 10 m (32.8 ft)
---	--

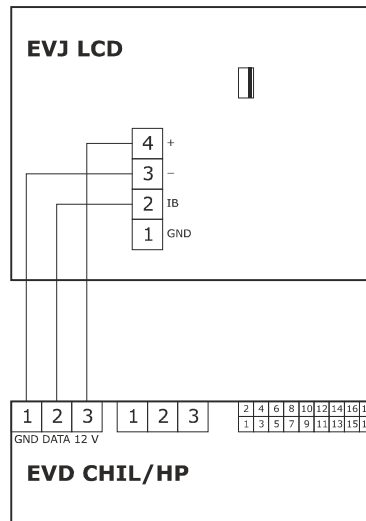

3.9.2 Models to be mounted on the wall

The diagram below shows the layout of the EVJ LCD connectors for wall installation.

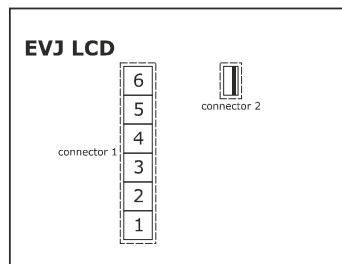

The tables below describe the EVJ LCD connectors for wall installation.

Connector 1

Part	Description
1	- negative signal RS-485 INTRABUS port in the EVJD900N2VWTX model - INTRABUS port reference (GND) otherwise
2	- positive signal RS-485 INTRABUS port in the EVJD900N2VWTX model - INTRABUS port signal otherwise
3	EVJ LCD power supply (12 VAC/DC not insulated); if the device is powered by direct current, connect the negative terminal
4	EVJ LCD power supply (12 VAC/DC not insulated); if the device is powered by direct current, connect the negative terminal
5	for EVCO use only
6	for EVCO use only

Connector 2

For EVCO use only.

3.9.2.1 Example of electrical connection of EVJ LCD models for wall installation

The diagram below shows an example of the connection of the EVJ LCD models (with INTRABUS port) for wall installation. In the example EVJ LCD has an independent power source.

	<p>N.B.</p> <ul style="list-style-type: none"> - do not power another device with the same transformer - the maximum permitted length for connection cables of the INTRABUS port is 30 m (98.4 ft)
---	--

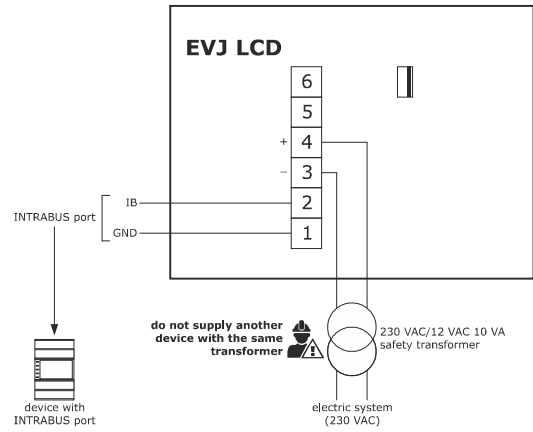

The diagram below shows an example of the connection of the EVJ LCD models (with INTRABUS port) for wall installation. In the example EVJ LCD is powered by an EVD CHILL/HPRU controller.

	<p>N.B.</p> <ul style="list-style-type: none"> - EVJ LCD must not be powered with an EV3 CHILL/HPRU controller - the maximum permitted length for connection cables of the INTRABUS port is 10 m (32.8 ft)
--	--

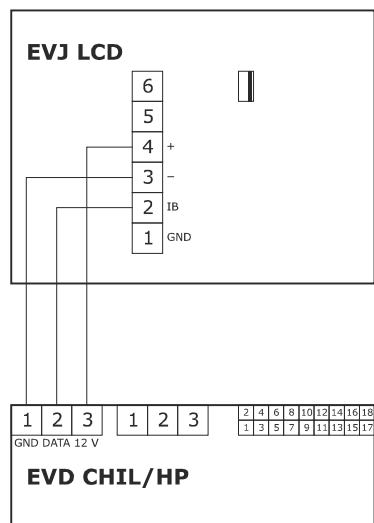

The diagram below shows an example of the connection of the EVJ LCD models (with RS-485 INTRABUS port) for wall installation. In the example EVJ LCD has an independent power source.

	<p>N.B.</p> <ul style="list-style-type: none"> - do not power another device with the same transformer - the INTRABUS/RS-485 EVIF22ISX serial interface should be used - the maximum permitted length for connection cables of the RS-485 INTRABUS port is 1 m (3.280 ft)
---	--

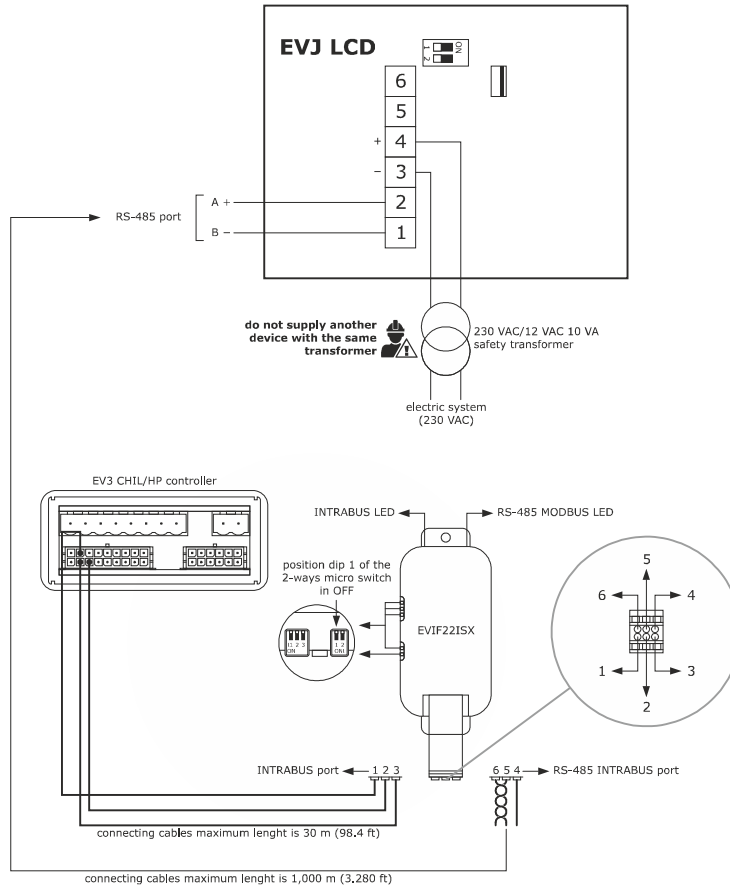

The table below describes the connectors of the INTRABUS/RS-485 EVIF22ISX serial interface.

Port	Terminal	Description
INTRABUS	1	12 V
	2	INTRABUS port signal
	3	INTRABUS port reference (GND)
RS-485	4	RS-485 port reference (GND)
	5	negative signal RS-485 port
	6	positive signal RS-485 port

3.9.3 Models to be mounted on the wall with rear housing in a built-in box

The diagram below shows the layout of the EVJ LCD models for wall installation with rear housing in a built-in box.

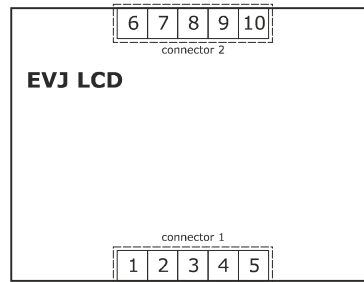

The tables below describe the EVJ LCD connectors for wall installation with rear housing in a built-in box.

Connector 1

Part	Description
1	EVJ LCD power supply (115... 230 VAC insulated)
2	EVJ LCD power supply (115... 230 VAC insulated)
3	for EVCO use only
4	for EVCO use only
6	for EVCO use only

Connector 2

Part	Description
6	for EVCO use only
7	for EVCO use only
8	for EVCO use only
9	INTRABUS port signal
10	INTRABUS port reference (GND)

3.9.3.1 Example of electrical connection of EVJ LCD models for wall installation with rear housing in a built-in box

The diagram below shows an example of the connection of the EVJ LCD models for wall installation with rear housing in a built-in box.

	<p>N.B. The maximum permitted length for connection cables of the INTRABUS port is 30 m (98.4 ft)</p>
---	---

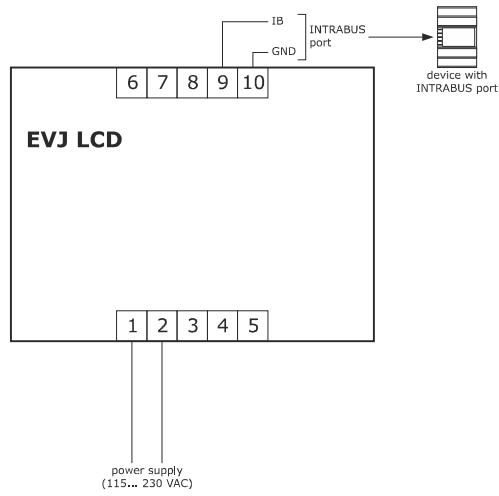

3.10 Description of EVD094 connectors

The diagram below shows the layout of the EVD094 connectors.

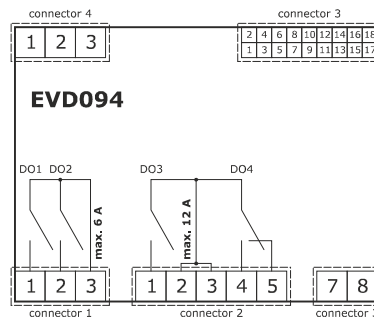

The tables below describe the EVD094 connectors.

Connector 1

Part	Description
1	electro-mechanical relay digital output DO1 (3A SPST): normally open
2	electro-mechanical relay digital output DO2 (3A SPST): normally open
3	electro-mechanical relay digital outputs DO1... DO4 (max. 6 A): common

Connector 2

Part	Description
1	electro-mechanical relay digital output DO3 (12A SPST): normally open
2	electro-mechanical relay digital outputs DO3... DO4 (max. 12 A): common
3	electro-mechanical relay digital outputs DO3... DO4 (max. 12 A): common
4	electro-mechanical relay digital output DO4 (8A SPDT): normally open
5	electro-mechanical relay digital output DO4: normally open
7	EVD094 power supply (115... 230 VAC insulated)
8	EVD094 power supply (115... 230 VAC insulated)

Connector 3

Part	Description
1	analogue output AO2 (0-10 V/PWM/phase cut)
2	analogue output AO1 (0-10 V/PWM/phase cut)
3	reference (GND)
4	analogue input IN1 (NTC/4-20 mA/0-5 V/0-10 V or dry contact)
5	analogue input IN10 (NTC or dry contact)
6	analogue input IN2 (NTC/4-20 mA/0-5 V/0-10 V or dry contact)
7	analogue input IN9 (NTC or dry contact)
8	analogue input IN3 (NTC or dry contact)
9	dry contact digital input pulse IN8
10	analogue input IN4 (NTC or dry contact)
11	dry contact digital input pulse IN7

12	analogue input IN5 (NTC or dry contact)
13	reference (GND)
14	dry contact digital input IN6
15	unused
16	auxiliary power supply output 12 VDC, max. 40 mA
17	open collector digital output OC1 (12 V, max. 40 mA)
18	reference (GND)

Connector 4

Part	Description
1	INTRABUS port reference (GND)
2	INTRABUS port signal
3	12 VDC output

3.10.1 Example of EVD094 electrical connection

The diagram below shows an example of the EVD094 electrical connection.

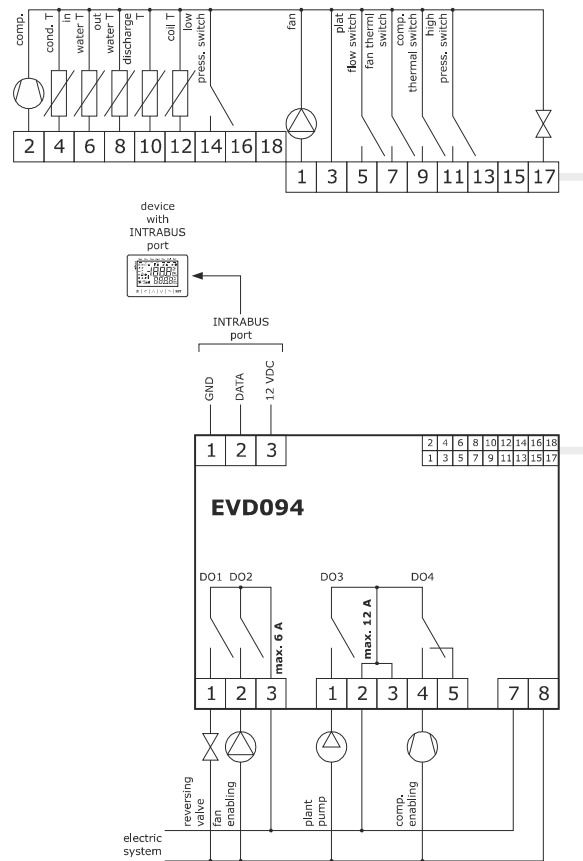

3.11 Termination of the RS-485 line

To terminate the RS-485 line of the EV3 CHILL/HPRU, place micro-switch 1 in the ON position. Do not touch micro-switch 2.

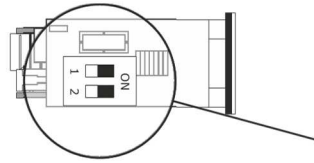

To terminate the RS-485 line of the EVD CHILL/HPRU, place micro-switch 1 in the ON position.

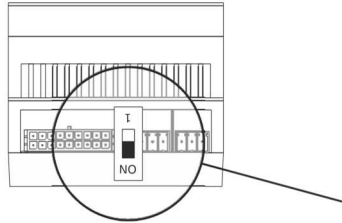

To terminate the RS-485 line of the EVJ LCD models with RS-485 INTRABUS port, place micro-switch 2 in the ON position. Do not touch micro-switch 1.

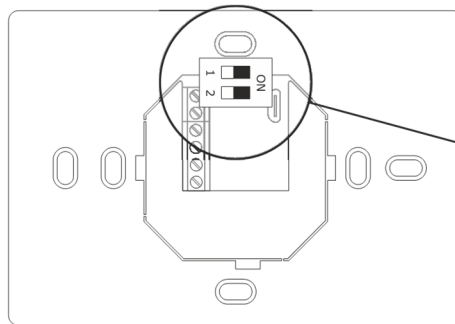









PRECAUTIONS FOR ELECTRICAL CONNECTION

- if using an electrical or pneumatic screwdriver, adjust the tightening torque
- if the device is moved from a cold to a warm place, humidity may cause condensing to form inside. Wait for about an hour before switching on the power
- make sure that the supply voltage, electrical frequency and power are within the set limits. See the section TECHNICAL SPECIFICATIONS
- disconnect the power supply before carrying out any type of maintenance
- the device must be fed by power of the same phase as that feeding any module with a phase-cutting command signal
- if TRIAC digital outputs are used it is advisable to connect a noise filter; do not touch the heat sink because it may reach very high temperatures
- do not use the device as a safety device
- for repairs and further information, contact the EVCO sales network; returned goods without the data label will not be accepted.

4 DESCRIPTION OF USER INTERFACE

4.1 Key functions

The table below shows the functions of the keys.

EV3 key	EVD key	EVJ key	Name	Function
			On/stand-by	<ul style="list-style-type: none"> - Holding the key down will switch the device on or off and return to the main page if in an internal menu - While setting the parameters, it functions as a "Back" key
SET		OK	Set	<ul style="list-style-type: none"> - Holding the key down will enable the user to enter the settings menu (SET menu) - Press once to modify the setpoint and confirm it - It functions as the "Enter" key in menu navigation
^		^	Up	<ul style="list-style-type: none"> - It enables the user to move to a higher menu - It enables the user to increase the value of a parameter - Holding the key down enables the user to view I/O status
v		v	Down	<ul style="list-style-type: none"> - It enables the user to move to a lower menu - It enables the user to decrease the value of a parameter - If no digital input is configured as the <i>Operating mode</i>, the machine operating mode is changed with every prolonged pressure following the sequence cold → hot → hot+DHW → cold (if the functions are enabled)
-		<	left	EVJ – From the home page press once the key to gain access to the quick menu to set configuration parameters and setpoint. EV3 – Not present EVD – Not used
-		>	right	EVJ - From the home page press once the key to gain access to the quick menu to set time bands. EV3 – Not present EVD – Not used

4.2 Display

The device can be switched on and off using the on/stand-by key. When it is switched on by a key, it can be placed in stand-by remotely by using a switch to alter the *Remote On/Off* digital input.

The user interface has two display modes.

Primary display mode:

- The top line shows the controlled value (parameter I01), while the bottom line a chosen probe, the setpoint or the time (parameter G08). If alarms are active, they are displayed. If remote control is active, the top line shows the status (ON or OFF) and the bottom line the number of steps or the activation time percentage of the compressors.
- When the device is switched on by a key but placed in stand-by remotely, the label "oFFd" appears on the bottom line.
- When the device is switched off by a key, the label "OFF" appears on the top line and the time on the bottom line (if the RTC is present and enabled, if not, 4 lines are displayed: ----).

Menu display mode:

- The information on the display depends on the menu level you are in, using a directory tree system where the bottom line shows a subcategory of the one shown on the top line. To help users identify what is being displayed, labels and codes are used.

4.2.1 Icons

The icons have four flashing modes:

- slow flash: 0.5 Hz
- normal flash: 1 Hz
- rapid flash: 2.5 Hz
- flash every 5 sec (1 sec off, 4 sec on).

EV3 CHILL/HPRU and EV3K01 display:

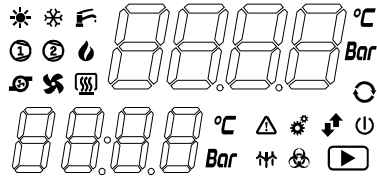

EVD CHILL/HPRU display:

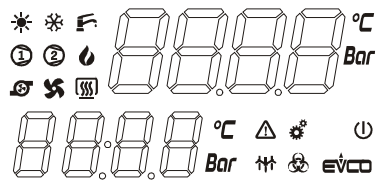



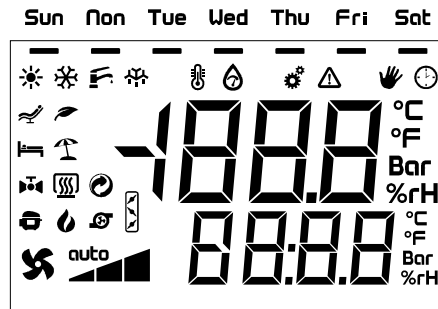



























EVJ LCD display:



4.2.2 Signals

The table below shows the meaning of the signal icons of EVJ LCD, EV3 CHILL/HPRU, EVD CHILL/HPRU and EV3K01.

EVJ LCD	EV3 CHILL/HPRU , EVD CHILL/HPRU and EV3K01	Colour	Meaning
		GREEN	Function active Depends on parameter G05 (default 0) 0  = heating ON /  = cooling ON 1  = heating ON /  = cooling ON
		GREEN	Domestic hot water (DHW) - ON function available but not active - OFF function not available - FLASHING function available and active
not present		GREEN	Compressor 1 Single circuit unit: - ON if only one compressor is switched on - OFF if all the compressors are switched off - FLASHING if the first compressor is in timed mode Dual-circuit unit - ON if at least one compressor of circuit 1 is switched on - OFF if no compressor of circuit 1 is switched on - FLASHING if some timings are in progress (irrespective of the circuit)
not present		GREEN	Compressor 2 Single circuit unit: - ON if at least two compressors are switched on - OFF if no more than one compressor is switched on - FLASHING if a compressor that is different from the first one is in timed mode Dual-circuit unit - ON if at least one compressor of circuit 2 is switched on - OFF if no compressor of circuit 2 is switched on - FLASHING if some timings are in progress (irrespective of the circuit)
	not present		Compressor - ON if one or more compressors are switched on - OFF if all the compressors are switched off - FLASHING if some timings are in progress
		GREEN	Pump - ON if the pump is switched on - OFF if the pump is switched off
		GREEN	Fan - ON if the fan is switched on - OFF if the fan is switched off
		GREEN	System heating element - ON if the heating element is switched on - OFF if the heating element is switched off
°C °F		AMBER	Unit of measurement of the value shown on the top display when the probe is configured for temperature
Bar	Bar	AMBER	Unit of measurement of the value shown on the top display when the probe is configured for pressure

		AMBER	Defrosting - ON if defrosting is in progress - OFF if defrosting is not in progress or has finished - FLASHING (2 s) if some timings are in progress for the start of the defrost cycle or if (1 s) dripping is in progress
not present		AMBER	Run - ON if the controller is switched on - OFF if the controller is switched off
		RED	Alarm - ON if an alarm is in progress - OFF if no alarm is in progress
		RED	Settings LED - ON if the device is not in primary view - OFF during normal operation
not present		RED	On/stand-by - ON if the controller is switched off (at the same time as the "OFF" display signal) - OFF if the controller is switched on
		RED	Unit of measurement of the value shown on the top display when the probe is configured for temperature
<i>Bar</i>	<i>Bar</i>	RED	Unit of measurement of the value shown on the top display when the probe is configured for pressure
not present		AMBER	Anti-legionella - ON if the function is active - otherwise it is OFF
not present		AMBER	Logo (only on the EVD9 LED display) - Always on
not present		RED	INTRABUS/RS-485 - Flashing slowly if communication through the INTRABUS or RS-485 is in progress - OFF if no communication is in progress

The table below describes the EVD CHILL/HPRU signalling LEDs.

LED	Colour	Meaning
ON	GREEN	Power supply LED - ON if the controller is powered - OFF if the controller is not powered
RUN	GREEN	RUN LED - ON if the controller is switched on - OFF if the controller is switched off
	RED	Alarm LED - ON if an alarm is in progress - OFF if no alarm is in progress
IB	AMBER	INTRABUS LED - FLASHING if INTRABUS communication is in progress - OFF if no communication is in progress
RS485	AMBER	RS-485 LED - FLASHING if RS-485 communication is in progress - OFF if no communication is in progress

5 MENU

5.1 Access levels

The ability to view a menu depends on the visibility level (which can be modified from the serial port) assigned to each option; the ability to view a parameter depends on the visibility of the individual parameter. Users can change the visibility level by setting the desired value (see section 7.1) through the serial port for both the different menu options and each individual parameter.

There are three access levels for navigating within the menus, two of which require a password:

U User: always visible

S Servicer: visible if the servicer password (parameter G11, default -12) or the manufacturer password (parameter CF10, default -123) have been entered

M Manufacturer: visible if the manufacturer password (parameter G12, default -123) has been entered

H Hidden: never visible from the user interface

5.2 Quick menus

Pressing the SET (EV3) / Enter (EVD) / OK (EVJ) key once takes the user directly to the *SEt* menu; if no digital input is configured as the *Operating mode*, holding the DOWN key down changes the active mode according to the sequence cold → hot → hot+DHW → cold (if the functions are enabled); holding the UP key down takes the user directly to the *Pro* sub-menu of the *IO* menu.

Pressing the ON/Standby (EV3/EVJ) / esc (EVD) key takes the user out of the active menu.

5.3 Access to the main menu

From the home page, holding down the SET (| SET | - EV3), Enter (⏴ - EVD) oppure OK (| OK | - EVJ LCD) key takes the user to the first accessible page of the main menu.

By pressing the UP or DOWN keys, the user can browse the menus in the order shown in the next section. By pressing the SET / Enter key, the user accesses the selected menu. The access level depends on the active password entered when accessing the relative menu (PSS); when the password has been entered, the device gives no immediate feedback but, if it is correct, it gives access to the parameters/menus which were previously inaccessible.

Pressing the ON/Standby (EV3/EVJ) / esc (EVD) key takes the user out of the active menu.

5.4 List of menus

The following menus are available:

Set Gives access to the quick setting of the control setpoints

IO Shows the I/O values

Pro Shows the temperature or pressure values of the inputs configured as probes

diG Shows the status of the inputs configured as digital inputs

AO Shows the status of the outputs configured as analogue outputs or triac/open collectors

rEL Shows the status of the outputs configured as digital outputs

ALM Shows the list of alarms in progress

Par Enables the device parameters to be displayed and changed. The parameters are grouped according to their function (identified on the display by a label). Each parameter has an alphabetic code followed by two numbers, as shown in the table below:

Group	Identification label	Parameter code
General	PG	G
Alarms	PA	A
I/O	PI	I
Control	Pr	r
Defrosting	Pd	d
Compressors	PC	C
Fans	PF	F
Pump	PP	P
Electrical heating elements	PH	H
Solar panels	PS	S

OHR Shows the operating working hours of

OU unit

OC1 compressor 1

OC2 compressor 2

OC3 compressor 3

OC4 compressor 4

OC5 compressor 5

OC6 compressor 6

OP pump

OF1 fan 1

OF2 fan 2

OF3 fan 3

OF4 fan 4



Press the SET key for about 3 seconds to reset the operating hours if at least the service level password has been entered (Questa frase non mi entusiasma...). This operation cancels any alarms relating to "operating hours exceeded" for the loads.

HiS Enables up to 20 alarm events to be saved

diS: the history is shown on the bottom display in the following sequence:

Alarm running number (starting from 0)

Alarm code

y xx year if the clock is available or alarm running number

M xx month if the clock is available

d xx day if the clock is available

hh:mm hours:minutes if the clock is available

cLS: deletes the history

- rtc** Enables the time to be set in devices with a clock
YEA: set year
Mon: set month
dAY: set day of the month
UdA: set day of the week
Hou: set hour
Min: set minutes
- inFo** enables the project data to be displayed in this sequence
Project
Variation
Revision:Version
- PAS** Enables entry of the password for accessing the desired level: parameter C18 for servicer level, C19 for manufacturer level.

5.5 Alarm menu and Alarm history

The *Alarms* menu displays active alarms in sequence. To delete the manual reset alarms (if the circumstances that caused the alarm have been rectified), the machine should **(must non è troppo forte?)** be switched off and then back on again.

The Alarm History menu contains the latest 20 alarms that are no longer active. By accessing the *diS* (display history) sub-menu and pressing the ON/Standby (EV3/EVJ anche in italiano) / Enter (EVD) key, the details of the alarm flash in sequence (see the previous section). Pressing the UP key takes the user to alarms with a higher index (older alarms), pressing the DOWN key to alarms with a lower index (more recent).

The *cLS* sub-menu allows the user to delete the history if his password level is high enough. When the sub-menu is accessed and the UP key pressed, the word "donE" will appear, confirming the history has been deleted.

5.6 Menu visibility

The visibility level of all the menus and parameters can be changed through the serial port using, for example, the parameter configuration tool EVCO Parameters Manager which can be downloaded free of charge from the EVCO website www.evco.it.

This enables the user to personalise how both the parameters and the complete menus are displayed, making navigation a lot easier.

6 SELECTING THE OPERATING MODES

The controller manages heating and cooling, depending on the configuration of the dedicated parameters.

There are three possibilities for selecting the operating mode:

- By digital input
- By keypad/supervisor.

If a digital input is configured as the *Operating mode*, the status of this input determines the operating mode.



If the change of operating mode by digital input is active, any attempt to change the mode from the keypad will fail and there will be no explanation of the reason for the failure of the action.

If a dedicated digital input is not configured, the operating mode is set through the keypad: each time the DOWN key is held down, the operating mode will change ...-> COOL -> HEAT.

In this situation the supervisor is able to force the operating mode (S05 status).

7 CONFIGURING A DEVICE

The following sections list all the possible configurations of the EV3 CHILL/HPRU and EVD CHILL/HPRU devices.

The parameter G02 enables a delay in device start-up to be set: until this time expires, no function start. This time enables the loads to start working properly.

7.1 Parameters

A visibility level is assigned to each parameter and it can be modified (only from the serial port using, for example, the free EVCO tool "Parameters Manager") with 4 possible values (the visibility value changes the level of the password to be entered to access the relative parameter via the keypad):

0 = Hidden (H)

1 = User (U)

2 = Servicer (S)

3 = Manufacturer (M)

Label	Chiller default value	Heat pump default value	Chiller visibility default value	Heat pump visibility default value	Min	Max	UM	Description
SEtP								Setpoint
Coo	8.5	8.5	U	U	r07	r05	°C;°F; Bar,psi*1 0	Cooling mode setpoint
HEA	40.0	40.0	H	U	r08	r06	°C;°F; Bar,psi*1 0	Heating mode setpoint
dhU	50.0	50.0	H	U	r08	r06	°C;°F	DHW mode setpoint
HGb	10.0	10.0	U	H	-58.0	99.9	°C; °F	Hot gas bypass setpoint
PG								General
G01	0	0	H	H	0	255		For EVCO only
G02	5	5	H	H	5	255	s	Functions activation delay from power ON
G03	1	1	S	S	1	247		MODBUS address
G04	2	2	S	S	0	3		MODBUS baud rate 0: 2400 1: 4800 2: 9600 3: 19200
G05	2	2	S	S	0	2		MODBUS parity 0: None 1: Odd 2: Even
G06	0	0	S	S	0	1		MODBUS stop bits 0: 1 stop bit 1: 2 stop bits
G07	0	0	S	S	0	1		Unit of measurement 0: °C/Bar 1: °F/psi

Label	Chiller default value	Heat pump default value	Chiller visibility default value	Heat pump visibility default value	Min	Max	UM	Description
G08	3	3	M	M	0	15		Visualisation second display 0: Time 1: AI1 2: AI2 3: AI3 4: AI4 5: AI5 6: AI6(EV3)/AI10(EVD) 7: AI7(EV3)/AI9(EVD) 8: AI1 EXP 9: AI2 EXP 10: AI3 EXP 11: AI4 EXP 12: AI5 EXP 13: AI10 EXP 14: AI9 EXP 15: Setpoint
G09	0	0	S	S	0	1		Meaning "sun" icon (☀) 0 = heating mode 1 = cooling mode
G10	0	0	S	S	0	1		Enable clock 0 = OFF 1 = ON
G11	-12	-12	S	S	-127	127		Service password
G12	-123	-123	M	M	-127	127		Manufacturer password
G13	0	1	H	M	0	1		Enable heating mode 0: OFF 1: ON
G14	1	1	H	M	0	1		Enable cooling mode 0: OFF 1: ON
G15	0	0	H	M	0	1		Enable DHW 0: OFF 1: ON
G16	1	1	M	H	1	2		Number of circuits
G17	1	1	M	M	0	6		Number of compressors per circuit 0 for dry cooler units/remote condenser
G18	0	0	M	M	-127	127	s	Solenoid valve operating mode 0: Depending on evaporating probe Other negative values: waiting time only at switch-on Other positive values: waiting time at switch-on and switch-off

Label	Chiller default value	Heat pump default value	Chiller visibility default value	Heat pump visibility default value	Min	Max	UM	Description
G19	0	0	M	H	0	1		Type of ventilation 0: Independent 1: Unique
G20	0	0	M	M	0	1		Enable expansion 0: Disabled 1: Enabled
G21	0	1	H	M	0	1		Enable system heating elements for integration 0: Disabled 1: Enabled
G22	0	0	H	M	0	1		Enable exclusive operation of boiler and system heating elements 0: Disabled 1: Enabled
G23	0	0	M	M	0	1		Enable dynamic setpoint 0: Disabled 1: Enabled
G24	0	1	H	M	0	1		Heat pump switch-off due to low external temperature 0: Disabled 1: Enabled
G25	0	0	H	M	0	2		Anti-legionella mode 0: Disabled 1: Enabled 2: Enabled with cycle at power ON
PA								Alarms
A01	3	3	M	M	0	255		LP alarm events in an hour for manual reset N.B.: the device manages all the alarms which occur within 225 seconds (1/16 of an hour) of the first one as a single event. This applies to all the alarms managed in this way
A02	120	120	M	M	0	255	s	LP alarm bypass time
A03	-10.0	-20.0	M	M	-58.0	99.9	°C;°F;Bar ;psi*10	LP alarm setpoint
A04	10.0	10.0	M	M	0.0	99.9	°C;°F;bar ;psi*10	LP alarm hysteresis
A05	3	3	M	M	0	255		HPRU alarm events in an hour for manual reset
A06	65.0	65.0	M	M	-58.0	99.9	°C;°F;bar ;psi*10	HPRU alarm setpoint
A07	25.0	25.0	M	M	0.0	99.9	°C;°F;bar ;psi*10	HPRU alarm hysteresis

Label	Chiller default value	Heat pump default value	Chiller visibility default value	Heat pump visibility default value	Min	Max	UM	Description
A08	5	5	M	M	0	255		Flow alarm events in an hour for manual reset
A09	30	30	M	M	0	255	s	Bypass time for flow alarm (from pump ON)
A10	3	3	M	M	0	255	s	Flow alarm delay (from flow switch activation)
A11	5	5	M	M	0	255	s	Flow re-arm alarm delay (from flow switch reset)
A12	30	30	H	M	0	255	s	Antifreeze alarm bypass time
A13	3	3	S	S	-58	99	°C;°F	Antifreeze alarm setpoint
A14	2.0	2.0	S	S	0.0	99.9	°C;°F	Antifreeze alarm hysteresis
A15	0	0	M	M	0	1		Fan block due to antifreeze alarm 0= Disabled 1= Enabled
A16	99	99	H	M	-58	99	°C;°F	High control temperature alarm setpoint
A17	5	5	H	M	0	255	s*10	High control temperature alarm delay
A18	105	105	M	M	50	300	°C;°F	Compressor discharge high temperature alarm setpoint
A19	15.0	15.0	M	M	0.0	25.5	°C;°F	Compressor discharge high temperature alarm hysteresis
A20	0	0	M	M	0	255		Fan alarm events in an hour for manual reset
A21	0	0	M	M	0	255	s	Fan alarm bypass time
A22	0	0	M	M	0	9,999	h*10	Maximum fan hour limit 0 = Disabled
A23	0	0	M	M	0	9,999	h*10	Maximum compressor hour limit 0 = Disabled
A24	0	0	M	M	0	9,999	h*10	Maximum pump hour limit 0 = Disabled
A25	0	0	M	M	0	255		Compressor thermal switch alarm events in an hour for manual reset
A26	40	40	M	M	0	255	Hz;%	Modulating compressor oil recovery setpoint
A27	5	5	M	M	0	255	min	Modulating compressor oil recovery delay
A28	0	0	H	M	-58	99	°C;°F	Disable heat pump setpoint due to low external temperature
A29	2.0	2.0	H	M	0.0	99.9	°C;°F	Disable heat pump hysteresis due to low external temperature

Label	Chiller default value	Heat pump default value	Chiller visibility default value	Heat pump visibility default value	Min	Max	UM	Description
PI								I/O
I01	0	0	M	M	0	4		Configuration control probe 0: Return temperature probe 1: Supply temperature probe 2: Temperature probe/sensor/ condensing pressure circuit 1 3: Temperature probe/sensor/ evaporating pressure circuit 1 4: Remote control 0-10V / 4-20 mA
I02	0	0	M	M	0	3		IN1 input type configuration 0 = NTC/Digital Input 1 = 4-20 mA 2 = 0-10 V 3 = 0-5 V
I03	0	0	M	M	0	3		IN2 input type configuration
I04	0	0	M	M	0	3		IN1 expansion input type configuration
I05	0	0	M	M	0	3		IN2 expansion input type configuration
I06	102	102	M	M	-30	120		IN1 input function configuration
I07	100	100	M	M	-30	120		IN2 input function configuration
I08	101	101	M	M	-30	120		IN3 input function configuration
I09	109	109	M	M	-30	120		IN4 input function configuration
I10	-1	106	M	M	-30	120		IN5 input function configuration
I11	-2	-1	M	M	-30	120		IN6 (EV3)/IN10 (EVD) input function configuration
I12	-5	-5	M	M	-30	120		IN7 (EV3)/IN9 (EVD) input function configuration
I13	-7	-7	M	M	-30	30		IN8 input function configuration
I14	-17	-17	M	M	-30	30		IN9 (EV3)/IN7 (EVD) input function configuration
I15	-19	-19	M	M	-30	30		IN10 (EV3)/IN6 (EVD) input function configuration
I16	0	0	M	M	-30	120		IN1 expansion input function configuration
I17	0	0	M	M	-30	120		IN2 expansion input function configuration
I18	0	0	M	M	-30	120		IN3 expansion input function configuration
I19	0	0	M	M	-30	120		IN4 expansion input function configuration

Label	Chiller default value	Heat pump default value	Chiller visibility default value	Heat pump visibility default value	Min	Max	UM	Description
I20	0	0	M	M	-30	120		IN5 expansion input function configuration
I21	0	0	M	M	-30	120		IN10 expansion input function configuration
I22	0	0	M	M	-30	120		IN9 expansion input function configuration
I23	0	0	M	M	-30	32		IN8 expansion input function configuration
I24	0	0	M	M	-30	30		IN7 expansion input function configuration
I25	0	0	M	M	-30	30		IN6 expansion input function configuration
I26	0.0	0.0	M	M	-15.0	300.0	bar ; psi*10; V; mA	Start of scale IN1[@4mA/0V] N.B.: if the input is configured as "Remote control", the linearisation parameters must be set using the value 0V/4mA for the minimum and 10V/20mA for the maximum.
I27	50.0	50.0	M	M	-15.0	300.0	bar ; psi*10; V; mA	Full scale IN1[@20mA/10V]
I28	0	0	M	M	-15.0	300.0	bar ; psi*10; V; mA	Start of scale IN2[@4mA/0V]
I29	20.0	20.0	M	M	-15.0	300.0	bar ; psi*10; V; mA	End of scale IN2[@20mA/10V]
I30	0.0	0.0	M	M	-15.0	300.0	bar ; psi*10; V; mA	Start of scale IN1 expansion[@4mA/0V]
I31	50.0	50.0	M	M	-15.0	300.0	bar ; psi*10; V; mA	End of scale IN1 expansion[@20mA/10V]
I32	0.0	0.0	M	M	-15.0	300.0	bar ; psi*10; V; mA	Start of scale IN2 expansion[@4mA/0V]
I33	20.0	20.0	M	M	-15.0	300.0	bar ; psi*10; V; mA	End of scale IN2 expansion[@20mA/10V]
I34	0.0	0.0	S	S	-99.9	99.9	°C;°F;Bar ; psi*10	IN1 analogue input offset
I35	0.0	0.0	S	S	-99.9	99.9	°C;°F;Bar ; psi*10	IN2 analogue input offset

Label	Chiller default value	Heat pump default value	Chiller visibility default value	Heat pump visibility default value	Min	Max	UM	Description
I36	0.0	0.0	S	S	-99.9	99.9	°C;°F	IN3 analogue input offset
I37	0.0	0.0	S	S	-99.9	99.9	°C;°F	IN4 analogue input offset
I38	0.0	0.0	S	S	-99.9	99.9	°C;°F	IN5 analogue input offset
I39	0.0	0.0	S	S	-99.9	99.9	°C;°F	IN6 (EV3)/IN10 (EVD) analogue input offset
I40	0.0	0.0	S	S	-99.9	99.9	°C;°F	IN7 (EV3)/IN9 (EVD) analogue input offset
I41	0.0	0.0	S	S	-99.9	99.9	°C;°F;Bar ; psi*10	IN1 expansion analogue input offset
I42	0.0	0.0	S	S	-99.9	99.9	°C;°F;Bar ; psi*10	IN2 expansion analogue input offset
I43	0.0	0.0	S	S	-99.9	99.9	°C;°F	IN3 expansion analogue input offset
I44	0.0	0.0	S	S	-99.9	99.9	°C;°F	IN4 expansion analogue input offset
I45	0.0	0.0	S	S	-99.9	99.9	°C;°F	IN5 expansion analogue input offset
I46	0.0	0.0	S	S	-99.9	99.9	°C;°F	IN10 expansion analogue input offset
I47	0.0	0.0	S	S	-99.9	99.9	°C;°F	IN9 expansion analogue input offset
I48	2	2	M	M	0	4		AO1 output configuration type 0= Disabled 1= Phase cut [%] 2= 0-10 V [%] 3= PWM [%] 4= Frequency [Hz]
I49	1	1	M	M	0	4		AO2 output configuration type
I50	0	0	M	M	0	4		AO1 expansion output configuration type
I51	0	0	M	M	0	4		AO2 expansion output configuration type
I52	100	100	M	M	1	200	Hz*10	PWM frequency
I53	100	100	M	M	1	200	Hz*10	PWM frequency
I54	1	16	M	M	-22	22		DO1 digital output function configuration
I55	12	12	M	M	-22	22		DO2 digital output function configuration
I56	2	2	M	M	-22	22		DO3 digital output function configuration
I57	3	3	M	M	-22	22		DO4 digital output function configuration
I58	0	0	M	M	-22	22		TK1 (EV3)/OC (EVD) digital output function configuration

Label	Chiller default value	Heat pump default value	Chiller visibility default value	Heat pump visibility default value	Min	Max	UM	Description
I59	0	0	M	M	-22	22		TK2 digital output function configuration
I60	0	0	M	M	-22	22		AO1 digital output function configuration
I61	0	0	M	M	-22	22		AO2 digital output function configuration
I62	0	0	M	M	-22	22		DO1 expansion digital output function configuration
I63	0	0	M	M	-22	22		DO2 expansion digital output function configuration
I64	0	0	M	M	-22	22		DO3 expansion digital output function configuration
I65	0	0	M	M	-22	22		DO4 expansion digital output function configuration
I66	0	0	M	M	-22	22		AO1 expansion digital output function configuration
I67	0	0	M	M	-22	22		AO2 expansion digital output function configuration
I68	0	0	M	M	-22	22		OC expansion digital output function configuration
I70	0	0	M	M	0	6		AO1 output function configuration 0= Disabled (can be used as DO) 1= Modulating compressor circuit 1 2= Modulating compressor circuit 2 3 = System pump 4 = Fans circuit 1 5 = Fans circuit 2 6 = Hot gas bypass valve
I71	4	4	M	M	0	6		AO2 output function configuration
I72	0	0	M	M	0	6		AO1 expansion analogue output function configuration
I73	0	0	M	M	0	6		AO2 expansion analogue output function configuration
I74	2	2	M	M	0	4		TK1 (EV3)/OC (EVD) output function configuration 0= Disabled (can be used as DO) 1 = System pump 2 = Fans circuit 1 3 = Fans circuit 2 4 = Hot gas bypass valve
I75	0	0	M	M	0	4		TK2 output function configuration
I76	0	0	M	M	0	4		OC expansion analogue output function configuration

Label	Chiller default value	Heat pump default value	Chiller visibility default value	Heat pump visibility default value	Min	Max	UM	Description
Pr								Control
r01	5.0	5.0	S	S	0.0	99.9	°C-°F-bar-psi*10	Control band in cooling mode
r02	5.0	5.0	H	S	0.0	99.9	°C-°F-bar-psi*10	Control band in heating mode
r03	5.0	5.0	H	S	0.0	99.9	°C;°F	DHW control band
r04	0	0	S	S	0	255	s*10	Integral ontrol time (PI)
r05	30.0	30.0	S	S	Coo	99.9	°C-°F-bar-psi*10	Maximum setpoint value in cooling mode
r06	60.0	60.0	H	S	HEA	199.9	°C-°F-bar-psi*10	Maximum setpoint value in heating mode
r07	4.0	4.0	S	S	-58.0	Coo	°C-°F-bar-psi*10	Minimum setpoint value in cooling mode
r08	20.0	20.0	H	S	0.0	HEA	°C-°F-bar-psi*10	Minimum setpoint value in heating mode
r09	5.0	5.0	S	S	-99.9	99.9	°C-°F-bar-psi*10	Dynamic setpoint offset in cooling mode
r10	10.0	10.0	H	S	-99.9	99.9	°C-°F-bar-psi*10	Dynamic setpoint offset in heating mode
r11	30	30	S	S	-58	99	°C-°F-bar-psi*10	Dynamic setpoint for external reference temperature in cooling mode
r12	15	15	H	S	-58	99	°C-°F-bar-psi*10	Dynamic setpoint for external reference temperature in heating mode
r13	10.0	10.0	S	S	-50.0	50.0	°C-°F-bar-psi*10	Dynamic setpoint for external temperature delta in cooling mode
r14	-10.0	-10.0	H	S	-50.0	50.0	°C-°F-bar-psi*10	Dynamic setpoint for external temperature in heating mode
r15	-5.0	-5.0	S	S	-58.0	99.9	°C-°F-bar-psi*10	Solenoid valve low pressure setpoint

Label	Chiller default value	Heat pump default value	Chiller visibility default value	Heat pump visibility default value	Min	Max	UM	Description
r16	6.0	6.0	H	S	0.0	99.9	°C-°F	Setpoint delta for DHW boiler heating elements in integration mode
r17	3	3	H	S	0	255	s	Bypass time on quitting DHW in heating mode
r18	70.0	70.0	H	S	50.0	199.9	°C-°F	Anti-legionella setpoint
r19	5	5	H	S	0	255	min	Anti-legionella holding time
r20	7	7	H	S	1	200	days	Anti-legionella interval
r21	1.0	1.0	S	H	0.1	r22	°C; °F	Neutral zone hot gas bypass
r22	3.0	3.0	S	H	r21	r23	°C; °F	Smart band hot gas bypass
r23	5.0	5.0	S	H	r22	99.9	°C; °F	Fast band hot gas bypass
r24	50.0	50.0	S	H	0.1	99.9	°C; °F	Proportional band hot gas bypass
r25	120	120	S	H	0	999	s	Integral time hot gas bypass
r26	30	30	S	H	0	999	s	Derivative time hot gas bypass
r27	67	67	S	H	1	100	%	Fast action correction factor hot gas bypass
r28	90	90	M	H	50	A18	°C; °F	Function inhibition setpoint hot gas bypass
r29	15.0	15.0	M	H	0.0	99.9	°C; °F	Function inhibition hysteresis hot gas bypass
r30	5	5	M	H	0	99	s	Hot gas bypass function activation delay from compressor switch-on
r31	50	50	M	H	0	100	%	Starting position hot gas bypass valve
r32	10	10	M	H	1	999	s	Period in PWM hot gas bypass valve
r33	10.0	10.0	M	H	1.0	10.0	V	PWM output voltage (AO 0-10 V) to control hot gas bypass valve
Pd								Defrosting
d01	0	1	H	M	0	3		Defrosting mode 0: Disabled 1: Pressure / Temperature 2: Compressors stopped 3: Time-controlled
d02	-5.0	-5.0	H	M	-58.0	99.9	°C;°F	Start defrost count setpoint
d03	20	20	H	M	0	255	min	Defrost activation delay
d04	15.0	15.0	H	M	-58.0	99.9	°C;°F	Defrost end setpoint
d05	5	5	H	M	0	255	min	Maximum defrost duration
d06	60	60	H	M	0	255	s	Waiting time from compressor OFF to reversing valve switching
d07	6	6	H	M	0	255	s*10	Dripping time

Label	Chiller default value	Heat pump default value	Chiller visibility default value	Heat pump visibility default value	Min	Max	UM	Description
d08	-10.0	-10.0	H	M	-58.0	d02	°C;°F	Forced defrost setpoint
d09	25	25	H	M	0	255	min	Delay between defrosting of 2 circuits
d10	3	3	H	M	0	255	s*10	Compressor switch-on delay in defrost mode
d11	50.0	50.0	H	M	-58.0	99.9	°C-°F-bar-psi*10	Fan activation setpoint in defrost mode
d12	10.0	10.0	H	M	0.0	99.9	°C-°F-bar-psi*10	Fan activation hysteresis in defrost mode
d13	30	30	H	M	0	255	Hz	Fan speed in defrost mode
PC								Compressors
C01	0	0	M	M	0	5		Compressor duty cycle number
C02	0	0	M	M	0	2		Type of compressors: 0: ON-OFF 1: Modulating 2: Modulating + ON-OFF
C03	0	0	M	M	0	3		Compressor rotation mode 0: Hours + Saturation 1: Fixed + Saturation 2: Hours + Balancing 3: Fixed + Balancing
C04	24	24	M	M	0	255	s*10	Minimum compressor OFF time Note: this value has been chosen in order to prevent the possibility that 2 following occurrences of LP alarm are considered as a single event.
C05	36	36	M	M	0	255	s*10	Minimum time between activations of the same compressor
C06	3	3	M	M	0	255	s*10	Minimum time between activations of different compressors
C07	5	5	M	M	0	255	s	Minimum time between switch-off of different compressors
C08	6	6	M	M	0	255	s*10	Start-up time at minimum capacity of modulating compressor
C09	20	20	M	M	10	255	Hz	Minimum modulating compressor value
C10	100	100	M	M	10	255	Hz	Maximum modulating compressor value
PF								Fans
F01	20	20	M	M	0	255	s/10	Fan start-up time

Label	Chiller default value	Heat pump default value	Chiller visibility default value	Heat pump visibility default value	Min	Max	UM	Description
F02	1	1	M	M	0	10	ms/2	Fan phase shift
F03	1	1	M	M	0	1		Fan dependence on compressor status 0: On request 1: Independent
F04	3.0	3.0	M	M	0.0	99.9	°C-°F-bar-psi*10	Fan control delta cut-off
F05	2.0	2.0	M	M	0.0	99.9	°C-°F-bar-psi*10	Fan control hysteresis cut-off
F06	30	30	M	M	0	255	s	Pre-ventilation time in cooling mode
F07	20	20	M	M	0	255	s	Post-ventilation time
F08	30	30	M	M	0	100	Hz-%	Minimum fan speed in cooling mode
F09	30	30	H	M	0	100	Hz-%	Minimum fan speed in heating mode
F10	100	100	M	M	0	100	Hz-%	Maximum fan speed in cooling mode
F11	100	100	H	M	0	100	Hz-%	Maximum fan speed in heating mode
F12	100	100	M	M	0	100	Hz-%	Maximum silent-mode fan speed in cooling mode
F13	100	100	H	M	0	100	Hz-%	Maximum silent-mode fan speed in heating mode
F14	30.0	30.0	M	M	-58.0	99.9	°C-°F-bar-psi*10	Minimum fan speed setpoint in cooling mode
F15	9.0	9.0	H	M	-58.0	99.9	°C-°F-bar-psi*10	Minimum fan speed setpoint in heating mode
F16	57.0	57.0	M	M	-58.0	99.9	°C-°F-bar-psi*10	Maximum fan speed setpoint in cooling mode
F17	0.0	0.0	H	M	-58.0	99.9	°C-°F-bar-psi*10	Maximum fan speed setpoint in heating mode
F18	20.0	20.0	M	M	0.0	99.9	°C-°F-bar-psi*10	Fan proportional band in cooling mode
F19	6.0	6.0	H	M	0.0	99.9	°C-°F-bar-psi*10	Fan proportional band in heating mode
F20	0	0	M	M	0	1		Step fan rotation sequence 0: Hours 1: Fixed

Label	Chiller default value	Heat pump default value	Chiller visibility default value	Heat pump visibility default value	Min	Max	UM	Description
PP								Pump
P01	1	1	M	M	0	1		Pump operating mode 0: Always active 1: On control request
P02	20	20	M	M	0	255	s	Compressor switch-on delay from pump switch-on
P03	10	10	M	M	0	255	s	Pump switch-off delay from compressor switch-off
P04	4	4	S	S	-58	99	°C-°F-bar-psi*10	Antifreeze setpoint for activating pump
P05	2.0	2.0	S	S	0.0	99.9	°C-°F-bar-psi*10	Antifreeze hysteresis for activating pump
P06	50	50	M	M	0	100	Hz-%	Modulating pump minimum speed
P07	5	5	M	M	-58	99	°C-°F-bar-psi*10	Modulating pump setpoint
P08	3.0	3.0	M	M	0.0	99.9	°C-°F-bar-psi*10	Modulating pump control band
PH								Electrical heating elements
H01	4	4	H	S	H04	H03	°C;°F	Boiler heating elements setpoint for antifreeze
H02	6	6	H	S	H04	H03	°C;°F	System heating elements setpoint for antifreeze
H03	10	10	M	M	H04	127	°C;°F	Maximum value boiler/system heating elements setpoint for antifreeze
H04	-10	-10	M	M	-58	H03	°C;°F	Minimum value boiler/system heating elements setpoint for antifreeze
H05	2.0	2.0	H	S	0.0	99.9	°C;°F	Boiler/system heating elements hysteresis in integration mode
H06	180	180	H	M	0	255	s*10	Activation boiler/system heating elements delay in integration mode
H07	6.0	6.0	H	M	0.0	99.9	°C;°F	System heating elements setpoint delta in integration mode
PS								Solar Panels
S01	5.0	5.0	H	S	0.0	99.9	°C; °F	Solar panel setpoint
S02	2.0	2.0	H	S	0.0	99.9	°C; °F	Solar panel hysteresis
S03	100	100	H	M	0	255	°C; °F	Over-temperature manifold setpoint

Label	Chiller default value	Heat pump default value	Chiller visibility default value	Heat pump visibility default value	Min	Max	UM	Description
S04	0	0	H	M	0	255	s	Pump ON time in over-temperature manifold
S05	10	10	H	M	0	255	s	Pump OFF time in over-temperature manifold
S06	30	30	H	M	-58	99	°C; °F	Solar panel antifreeze setpoint
S07	10.0	10.0	H	N	0.0	99.9	°C; °F	Solar panel antifreeze hysteresis
S08	65.0	65.0	H	S	dHU	r06	°C; °F	Solar DHW setpoint
S09	70	70	H	S	0	99	°C; °F	DHW over-temperature setpoint
S10	10.0	10.0	H	S	0.0	99.9	°C; °F	DHW over-temperature hysteresis
S11	60	60	H	S	0	255	s	3-way DHW valve running time

7.2 Configuring inputs

All the inputs can be configured by entering an appropriate value in the parameters I06-I25.

When a value below 100 is set, the input is configured as a digital input, when the value is above 100, it is configured as an analogue input.

The value that defines the function assigned to each digital input consists of an absolute value indicating the function and a sign showing its polarity:

Negative = Normally closed (NC)

Positive = Normally open (NO)

The value 0 indicates that no function is associated with the digital input.



If an unexpected value (see table) is set in parameters I06-I25, the value will not be rejected by the controller, but no function will be assigned to the input. If two or more inputs are configured with the same value, only the input with the highest index will be used.

7.2.1 Configuring input functions

Value of parameters I06-I25	Meaning
0	Disabled
1	Flow switch
2	Remote On/Off
3	Operating mode
4	Overload switch pump
5	Overload switch fan circuit 1
6	Overload switch fan circuit 2
7	Overload switch compressor 1
8	Overload switch compressor 2
9	Overload switch compressor 3
10	Overload switch compressor 4
11	Overload switch compressor 5
12	Overload switch compressor 6
13	Overload switch compressors circuit 1
14	Overload switch compressors circuit 2
15	Overload switch system heating elements
16	Overload switch boiler heating elements
17	High pressure switch circuit 1
18	High pressure switch circuit 2
19	Low pressure switch circuit 1
20	Low pressure switch circuit 2
21	Phase sequence relay
22	Generic alarm
23	Generic warning
24	Solar

25	Thermostat (step 1)
26	Thermostat (step 2)
27	Thermostat (step 3)
28	Thermostat (step 4)
29	Thermostat (step 5)
30	Thermostat (step 6)
100	Input water probe
101	Output water probe
102	Condensing probe circuit 1
103	Condensing probe circuit 2
104	Evaporating probe circuit 1
105	Evaporating probe circuit 2
106	Coil probe circuit 1
107	Coil probe circuit 2
108	External temperature probe
109	Discharge probe compressor 1
110	Discharge probe compressor 2
111	Discharge probe compressor 3
112	Discharge probe compressor 4
113	Discharge probe compressor 5
114	Discharge probe compressor 6
115	Discharge probe compressors circuit 1
116	Discharge probe compressors circuit 2
117	Domestic hot water probe
118	Solar panel manifold probe
119	Solar panel storage probe
120	Remote control input

7.2.2 Configuring universal type inputs

Value of parameters I02 - I05	Meaning
0	NTC / Digital input
1	4-20 mA
2	0-10 V
3	0-5 V

Important: only for EV3 CHILL/HPRU, if either input IN1 or IN2 has been set to powered up (0-5 V or 0-10 V), the other must be also. If this does not happen, the reading of the input powered up will be affected by the offset.

The choice of the type of probe influences the unit of measurement used: probes measuring temperature return values in °C or °F depending on the setting of parameter G07, while probes measuring power or voltage use the units bar or psi in accordance with the conversion scales set by parameters I26-I33 that determine the scale start and end values for sensors configured as humidity, pressure or remote control probes.

7.3 Configuring analogue outputs

There are 2 analogue outputs, AO1 and AO2, and two more in the expansion. The parameters I48 and I49 (I50 and I51 for the expansion) determine the type of output: 0-10 V, phase cut, PWM, frequency or disabled.

7.3.1 Configuring type AO

Value of parameters I48-I51	Meaning
0	Disabled (or DO)
1	Phase cut
2	0-10 V
3	PWM
4	Frequency

The choice of the output type influences the unit of measurement: frequency outputs are measured in Hz, whereas phase cut, power and PWM outputs are measured in %.

7.3.1.1 Disabled (or DO)

If the analogue output is disabled, it can be used as a DO digital output.

7.3.1.2 Phase cut (with AC power only)

A synchronised pulse of 500 us is generated at the output with the 0 of the device's power supply voltage. The delay of the pulse with respect to the zero-crossing is calculated so the value set is that of the effective load voltage.



If the output value is below 20%, the output will NOT be active. If the output value is above 90%, the output will always be active.

Parameter F01 sets a start-up time which is applied when the output shifts from 0% to a different value: for this time the output is forced at 100%.

The F02 parameter makes it possible to set a shift to adapt the load.

The conversion table used is as follows:

50 Hz					
Out min [%]	Out max [%]	num tick 500 us	Talfa [ms]	Veff [V]	Vperc [%]
0	19	Always off			
20	25	16	8.0	51	22
26	33	15	7.5	69	30
34	42	14	7.0	89	39
43	50	13	6.5	108	47
51	58	12	6.0	127	55
59	66	11	5.5	146	63
67	73	10	5.0	163	71
74	79	9	4.5	178	77
80	85	8	4.0	192	83
86	89	7	3.5	203	88
90	100	Always on			

60 Hz					
Out min [%]	Out max [%]	num tick 500 us	Talfa [ms]	Veff [V]	Vperc [%]
0	19	Always off			
20	29	13	6.5	58	25
30	39	12	6.0	81	35
40	49	11	5.5	104	45
50	59	10	5.0	127	55
60	68	9	4.5	149	65
69	76	8	4.0	169	73
77	83	7	3.5	186	81
84	89	6	3.0	201	87
90	100	Always on			

7.3.1.3 0-10 V

The output voltage varies according to the value set: 0% output always off, 100% output at 10 V.

7.3.1.4 PWM

A signal with constant frequency and variable duty cycle is generated at the output.

The frequency of the output configured as PWM is determined by parameters I52 and I53.

The duty cycle varies according to the value set: 0% output always off, 100% output always on.

7.3.1.5 Frequency

A signal with variable frequency and fixed duty cycle is generated at the output.

The frequency of the output varies according to the value set: below 10 Hz the output is always off. The maximum frequency value is 255 Hz. The duty cycle is always 50%.

7.3.1.6 Exclusions

It is not permitted for one analogue output to be configured as 0-10 V and the other as PWM or as a frequency. The table below outlines the permitted (O) and prohibited (X) configurations.

I48\I49	0	1	2	3	4
0	O	O	O	O	O
1	O	O	O	O	O
2	O	O	O	X	X
3	O	O	X	O	X
4	O	O	X	X	X

7.3.2 Configuring AO function

Parameters I70-73 determine the function of the analogue outputs in accordance with the following table:

Value of parameters I70-I73	Meaning
0	Disabled
1	System pump
2	Compressor circuit 1
3	Compressor circuit 2
4	Fans circuit 1
5	Fans circuit 2
6	Hot gas bypass valve control (PWM on 0-10 V)

7.4 Configuring triac and open collector outputs as analogue outputs

Model EV3 CHILL/HPRU has 2 triac outputs (with an optional board), while model EVD CHILL/HPRU has one open collector output. They can be configured with parameters I74-I77 and controlled in phase cut.

If the triac/OC outputs are disabled, they can be used as DO digital outputs.

Triac/OC outputs have % as their unit of measurement.

Value of parameters I74-I77	Meaning
0	Disabled (or DO)
1	System pump
2	Fans circuit 1
3	Fans circuit 2
4	Hot gas bypass valve control

7.5 Configuring digital outputs

The parameters between I54 and I69 configure the function associated with the digital outputs.

Both the analogue and triac outputs can be configured as digital outputs if they have been set to disabled in parameters I74-I77 and/or I48-I51.

As with the digital inputs, the parameters defining the function assigned to each digital output consist of an absolute value indicating the function and a sign showing its polarity:

Negative = Normally closed (NC)

Positive = Normally open (NO)

The value 0 indicates that no function is associated with the digital output.

Value of parameters I54-I69	Meaning
0	Disabled
1	Alarm
2	System pump
3	Compressor 1 (*)
4	Compressor 2 (*)
5	Compressor 3 (*)
6	Compressor 4 (*)
7	Compressor 5 (*)
8	Compressor 6 (*)
9	Solenoid valve circuit 1

Value of parameters I54-I69	Meaning
10	Solenoid valve circuit 2
11	Defrosting
12	Fans circuit 1 (step 1)
13	Fans circuit 2 (step 2)
14	Fans circuit 1 (step 3) / Fans circuit 2 (step 1)
15	Fans circuit 1 (step 4) / Fans circuit 2 (step 2)
16	Reversing valve circuit 1
17	Reversing valve circuit 2
18	System heating elements
19	DHW boiler heating element
20	Solar panel pump
21	DHW valve
22	Hot gas bypass HGBP valve

(*) Compressors 1, 2 and 3 always refer to circuit 1. If there is a unit with 2 circuits, the first compressor of the second circuit will always be compressor 4. For example, in a chiller with 4 compressors on 2 circuits, compressors 1, 2, 4 and 5 must be configured.

8 SERIAL PORTS

Controllers EV3 CHILL/HPRU and EVD CHILL/HPRU have the following serial ports:

- INTRABUS baud rate 19,200, even, 1 stop bit
 - proprietary communications protocol INTRABUS node 1 (MASTER)
- RS-485 baud rate from parameter C61 (default 9600)
 - even from parameter C62 (default even)
 - stop bit from parameter C63 (default 1)
 - MODBUS SLAVE communications protocol node from parameter C22 (default=1).

The RS-485 MODBUS serial port can be used to communicate with a supervision system or a personal computer.

The document "MODBUS IMPLEMENTATION TABLE" (available on request) describes the resources of the devices accessible via the RS-485 serial port. The document is available on the www.evco.it website.

The INTRABUS serial port enables a remote keypad (EVK3K01 or EVJ LCD) to be connected to the EV3 CHILL/HPRU or the EVD CHILL/HPRU controller.

The INTRABUS serial port enables a remote keypad (EVK3K01 or EVJLCD) and an EVD EXP expansion to be connected to the controller.

9 CONTROL FUNCTIONS

9.1 Initial information

The sun (☀) and snowflake (❄) icons can be configured by parameter G05 according to the following coding:

- G09 = 0 ☀ = heating / ❄ = cooling
- G09 = 1 ❄ = heating / ☀ = cooling

Control functions are based on the value detected by the sensor set by parameter I01 and by the setpoint set or by the status of the digital inputs or the analogue input for the capacity control.

Depending on the value of parameter I01, units of different types and with different purposes can be managed according to the table below. This table is given only as an indication.

I01	Description	Type of unit
0	Return temperature probe	Chillers and heat pumps managed according to the water return temperature
1	Supply temperature probe	Chillers and heat pumps managed according to the water supply temperature
2	Temperature probe / evaporating pressure sensor circuit 1	Condensing unit units for refrigeration managed according to the value of the temperature or the circuit suction pressure. N.B. It does not make sense to manage these units "in hot mode" or manage the second circuit, even though these options are not inhibited
3	Temperature probe / condensing pressure sensor circuit 1	Dry cooler units (temperature) or remote condensers (pressure). N.B. It does not make sense to control these units "in hot mode", even though this option is not inhibited
4	Modulating control	Condensing units for HVAC where the required capacity is determined by the internal direct expansion unit(s) through a modulating control

9.2 Operating mode

Several operating modes are available:

- Parameter G13 enables the Heating function
- Parameter G14 enables the Cooling function

If no mode is enabled, the unit will work in Cooling mode.

The operating mode can be selected on the keypad: every time the Down key is held down, it goes from one mode to another.

The reversing valve changes status after half the time C04 from when the operating mode is modified. The compressors are forcibly switched off for at least the time C04 from when the operating mode is modified.

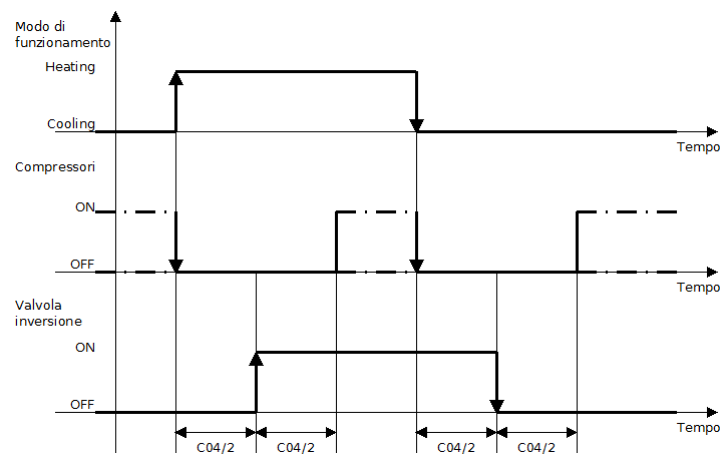

9.3 Setting the control probe

The control probe is set by parameter I01:

- I01 = 0 : Return water temperature probe (100)
- I01 = 1 : Supply water temperature probe (101)
- I01 = 2 : Temperature probe / condensing pressure transducer circuit 1 (102)
- I01 = 3 : Temperature probe / evaporating pressure transducer circuit 1 (104)
- I01 = 4 : Remote control (120)

9.4 Compressors

9.4.1 Initial information

The controller can manage up to 6 digital outputs to activate 6 compressors, plus one or two analogue outputs to control modulating compressors. A relay on the controller must be associated with each compressor using parameters I54-I69. Any analogue outputs may be configured using parameters I70-I73.

Parameter G16 determines the number of machine circuits, parameter G17 the number of compressors for each circuit and parameter C01 the number of unloaders for each compressor.

The number of digital outputs needed is calculated using the formula:

$$(G16) * (G17) * (C01+1)$$

If the result is greater than 6, the device signals a configuration error.

Parameter C02 determines which types of compressors will be used.

- C02 = 0: only ON/OFF compressors
- C02 = 1: only modulating compressors
- C02 = 2: 1 modulating compressor and $((G17) * (C01+1) - 1)$ ON/OFF compressors per circuit

The following combinations are possible and the table below shows how they must be associated with the digital outputs.

Single circuit:

1. up to 6 ON/OFF compressors without unloaders, connecting each compressor to a correctly configured digital output
2. up to 3 ON/OFF compressors each with one unloader, connecting each step of the compressors to a correctly configured digital output
3. up to 2 ON/OFF compressors each with two unloaders, connecting each step of the compressors to a correctly configured digital output
4. 1 compressor with up to 5 unloaders, connecting each step of the compressor to a correctly configured digital output
5. 1 modulating compressor with enable signal and up to 5 ON/OFF compressors, connecting the enable signal of the modulating compressor to a correctly configured digital output (Compressor 1), the command signal of the modulating compressor to a correctly configured analogue output and each of the ON/OFF compressors to a correctly configured digital output (Compressors 2-6)

up to 6 modulating compressors, connecting the enable signal of each of them to a correctly configured digital output (Compressors 1-6) and the command signal of each compressor to one correctly configured analogue output

Dual-circuit, for each circuit:

6. up to 3 ON/OFF compressors without unloaders, connecting each compressor to a correctly configured digital output
7. 1 compressor with 1 or 2 unloaders, connecting each step of the compressor to a correctly configured digital output
8. 1 modulating compressor with enable signal, connecting the enable signal to a correctly configured digital output and the command signal of the compressor to a correctly configured analogue output and up to 2 ON/OFF compressors
9. up to 3 modulating compressors, connecting the enable signal of each of them to a correctly configured digital output (Compressors 1-6) and the command signal of each compressor to one correctly configured analogue output

Outputs Cases	Compressor 1	Compressor 2	Compressor 3	Compressor 4	Compressor 5	Compressor 6	
Single circuit	1	Compressor 1	Compressor 2	Compressor 3	Compressor 4	Compressor 5	Compressor 6
	2	Compressor 1	Compressor 1 Unloader 1	Compressor 2	Compressor 2 Unloader1	Compressor 3	Compressor 3 Unloader1
	3	Compressor 1	Compressor 1 Unloader1	Compressor 1 Unloader2	Compressor 2	Compressor 2 Unloader1	Compressor 2 Unloader2
	4	Compressor 1	Compressor 1 Unloader1	Compressor 1 Unloader2	Compressor 1 Unloader3	Compressor 1 Unloader4	Compressor 1 Unloader5
	5	Enable Compressor 1 (modulating)	Compressor 2 (On/Off)	Compressor 3 (On/Off)	Compressor 4 (On/Off)	Compressor 5 (On/Off)	Compressor 6 (On/Off)
	6	Enable Compressor 1 (modulating)	Enable Compressor 2 (modulating)	Enable Compressor 3 (modulating)	Enable Compressor 4 (modulating)	Enable Compressor 5 (modulating)	Enable Compressor 6 (modulating)
Dual-circuit	7	Compressor 1 (circuit 1)	Compressor 2 (circuit 1)	Compressor 3 (circuit 1)	Compressor 4 (circuit 2)	Compressor 5 (circuit 2)	Compressor 6 (circuit 2)
	8	Compressor 1 (circuit 1)	Compressor 1 Unloader1 (circuit 1)	Compressor 1 Unloader2 (circuit 1)	Compressor 2 (circuit 2)	Compressor 2 Unloader1 (circuit 2)	Compressor 2 Unloader2 (circuit 2)
	9	Enable Compressor 1 (modulating) (circuit 1)	Compressor 2 (On/Off) (circuit 1)	Compressor 3 (On/Off) (circuit 1)	Enable Compressor 4 (modulating) (circuit 2)	Compressor 5 (On/Off) (circuit 2)	Compressor 6 (On/Off) (circuit 2)
	10	Enable Compressor 1 (modulating) (circuit 1)	Enable Compressor 2 (modulating) (circuit 1)	Enable Compressor 3 (modulating) (circuit 1)	Enable Compressor 4 (modulating) (circuit 2)	Enable Compressor 5 (modulating) (circuit 2)	Enable Compressor 6 (modulating) (circuit 2)

Parameter C03 sets the order in which the compressors in the multi compressor circuit are switched on.

- C03 = 0: compressors rotated according to operating hours and circuits according to saturation
- C03 = 1: fixed compressor rotation and circuits rotated according to saturation
- C03 = 2: compressors rotated according to operating hours and circuits according to balancing
- C03 = 3: fixed compressor rotation and circuits rotated according to balancing

Parameter C04 sets the minimum time between a compressor being switched off and then switched back on again, while parameter C05 sets the minimum time between two consecutive switch-ons (and, as a result, the maximum number of switch-ons in an hour).

Parameter C06 sets the minimum time between two switch-ons of different compressors, while parameter C04 sets the minimum time between two switch-offs of different compressors.

Parameters C09 and C10 have a different function according to the type of analogue output which is selected by parameter I48: if the output is a frequency, they represent the maximum and minimum working frequencies, otherwise they represent the maximum and minimum working percentages.

Control is based on the reading of the sensor set by parameter I01 and by the setpoint set.

The controllers can work in cooling mode (chiller) if parameter G14 is configured correctly.

The controllers can work in heating mode (heat pump) if parameter G13 is configured correctly.

The control band in cooling mode is set by parameter r01.

The control band in heating mode is set by parameter r02.

The graphs in the following sections represent the proportional control in cooling mode on the left and heating mode on the right.

To keep it simple, the integral component is not represented (r04 = 0). The compressor enable signal output is also shown for modulating compressors.

9.4.2 Single circuit controls

9.4.2.1 Single circuits with On/Off compressors

The following are some of the possible combinations for ON-OFF adjustment.

- 1 compressor without unloaders (G16=1 G17=1; C01=0; C02=0). The compressor is connected to the output configured as *Compressor 1*.

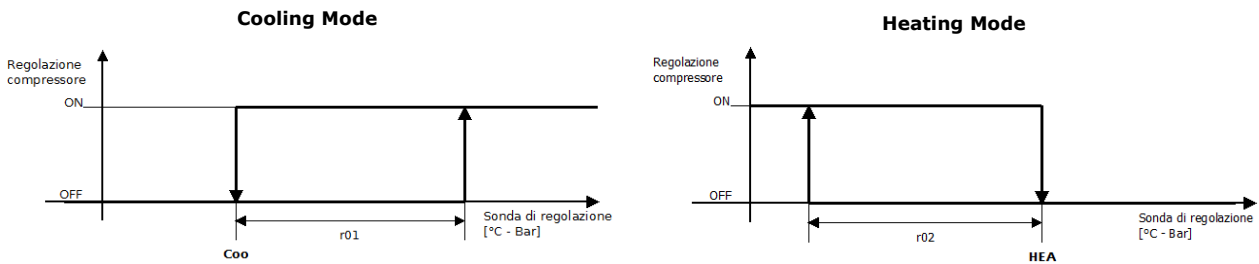

- 2 independent compressors without unloaders (G16=1 G17=1; C01=0; C02=0). The first compressor is connected to the digital output configured as *Compressor 1* and the second compressor to the output configured as *Compressor 2*. The graph refers to fixed rotation of the compressors (C03 = 1 or 3).

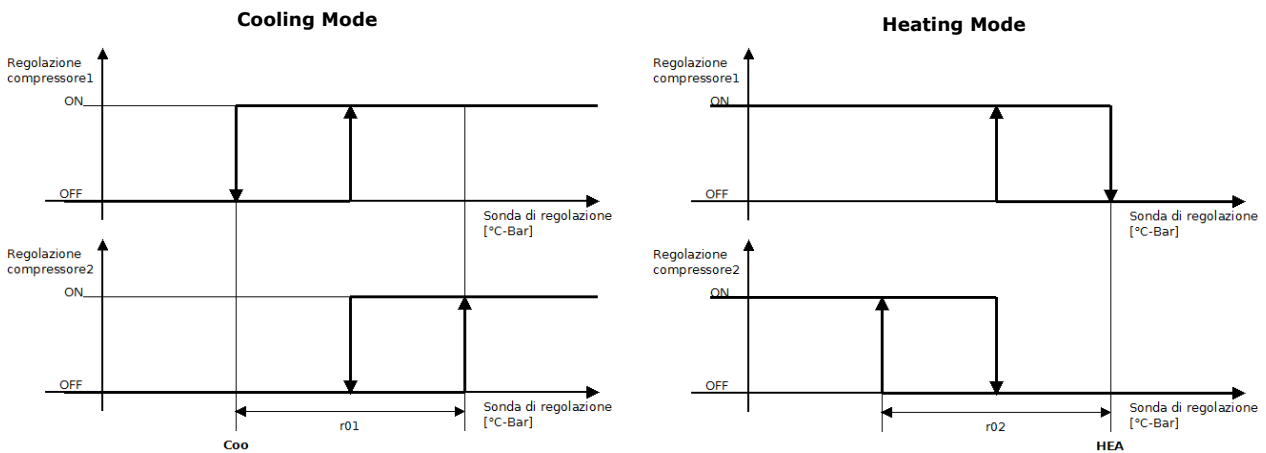

- 1 compressor with one unloader (G16=1 G17=1; C01=0; C02=0). The first step of the compressor is connected to the digital output configured as *Compressor 1* and the second step of the compressor to the output configured as *Compressor 2*.

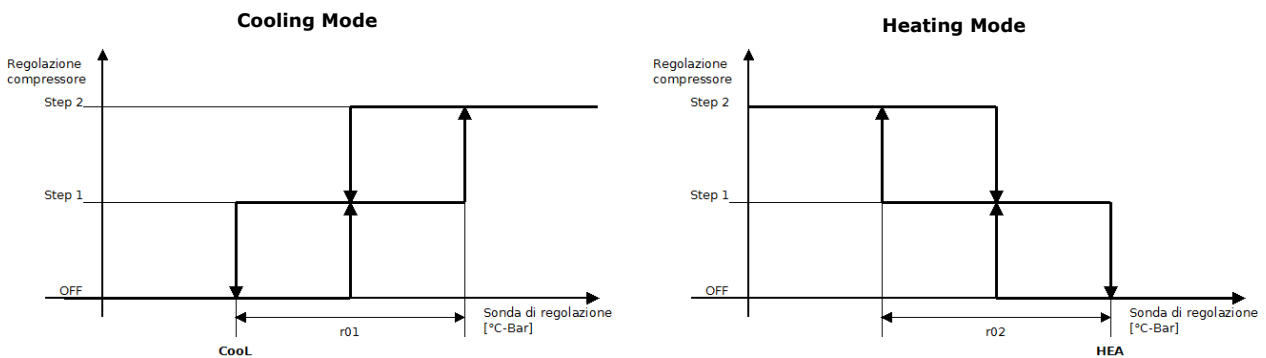

- 1 compressor with five unloaders (G16=1 G17=1; C01=5; C02=0). The first step of the compressor is connected to the digital output configured as *Compressor 1*, the second step to the output configured as *Compressor 2*, the third step to the output configured as *Compressor 3*, the fourth step to the output configured as *Compressor 4*, the fifth step to the output configured as *Compressor 5* and the sixth step to the output configured as *Compressor 6*.

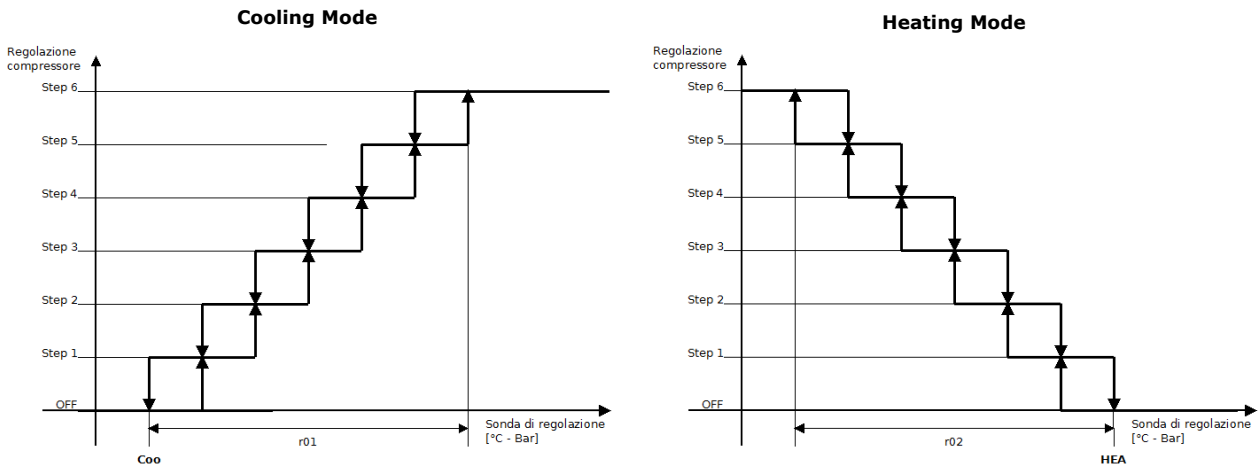

9.4.2.2 Single circuit 1 modulating compressor

In this case the only compressor will modulate with a "simple" ramp from the minimum value (C09) to the maximum value (C10) according to the capacity control request.

The configuration of the parameters is G16=1, G17=1, C01=0, C02=1. The modulating compressor is connected to the analogue output configured as *Compressor 1*, the enable signal is connected to the output configured as *Compressor 1*.

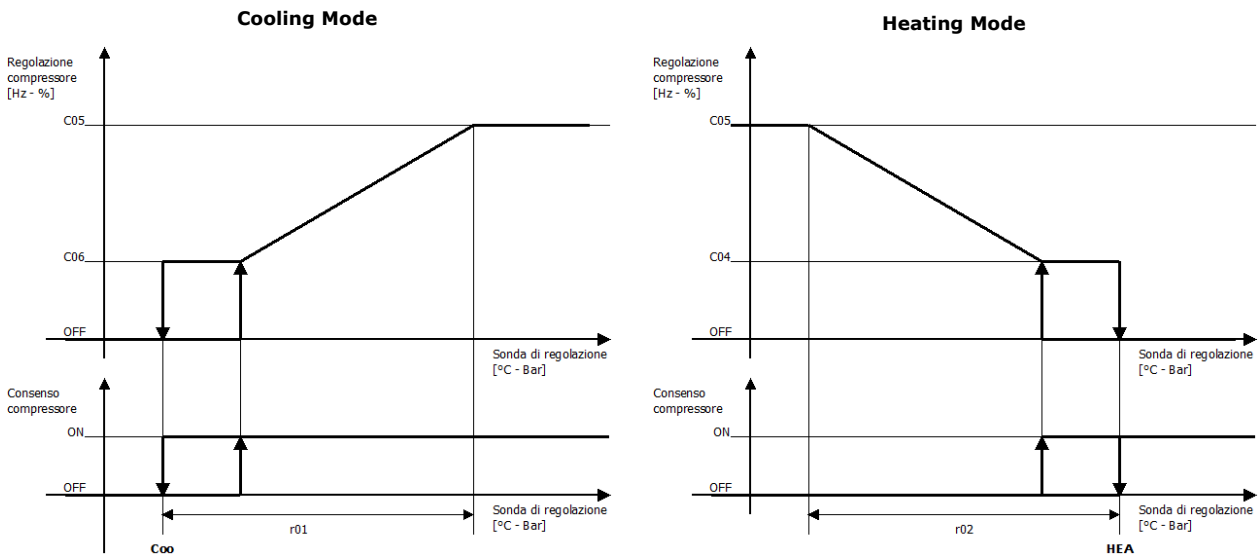

9.4.2.3 Single circuit 1 modulating compressor + up to 5 ON/OFF compressors

In this case the modulating compressor will have a "sawtooth" action, while the ON/OFF compressors will be activated "in steps". Only the case of 5 ON/OFF compressors will be described; the remaining cases (from 1 to 4 ON/OFF compressors besides the modulating compressor) can be deduced from this case: the configuration of the parameters is G16=1, G17=6, C01=0, C02=2.

The modulating compressor is connected to the *Compressor 1* analogue output and its enable signal to the *Compressor 1* digital output, the first On/Off compressor is connected to the *Compressor 2* digital output, the second On/Off compressor to the *Compressor 3* digital output, the third On/Off compressor to the *Compressor 4* digital output, the fourth On/Off compressor to the *Compressor 5* digital output, the fifth On/Off compressor to the *Compressor 6* digital output.

The graph refers to fixed rotation of the compressors (C03 = 1 or 3). For the sake of brevity, the case is illustrated in cooling mode only.

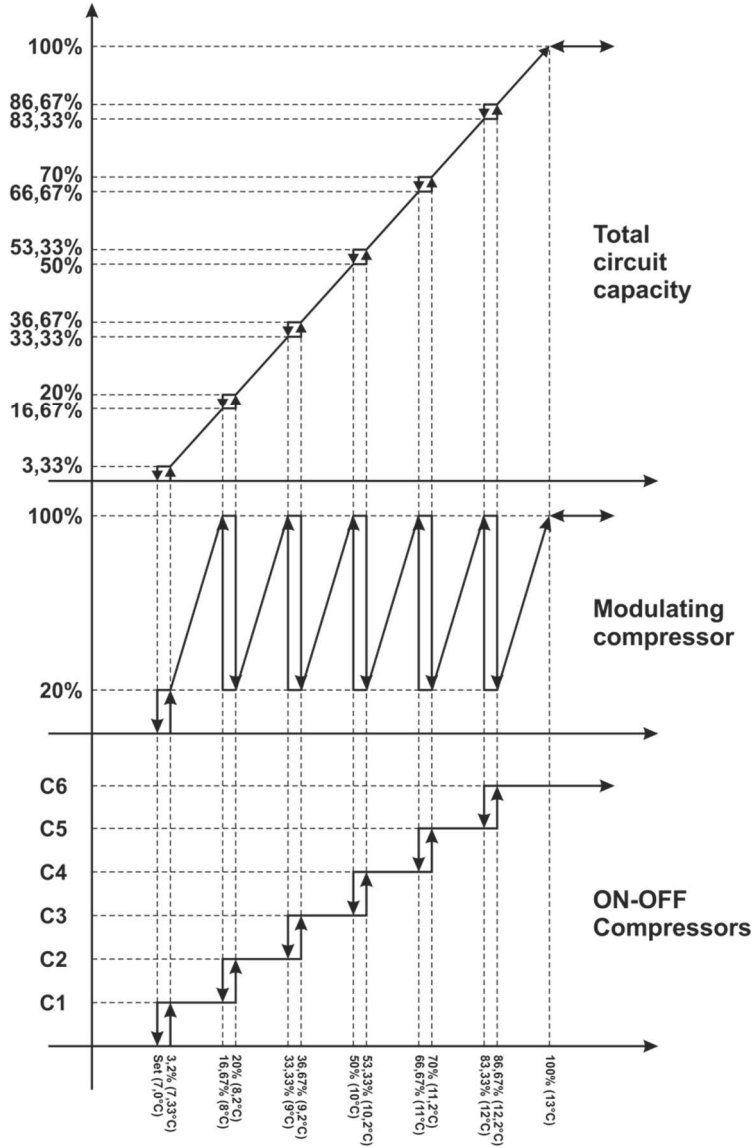

**1 modulating compressor + 5 ON-OFF compressors (1/6 each)
Min value modulating Compr = 20% Set = 7°C, PB = 6°C**

9.4.2.4 Single circuit 3 modulating compressors

In this case all the compressors have the same rotation frequency and will be enabled in sequence and made to modulate in order to maintain the same percentage compared to the total percentage in the cases of switch-ons/off. When a compressor is activated, all the compressors will be readied for start-up rotation for the time needed (C08) for the activated compressor to start up correctly. Normal control will resume after this temporary phase.

The configuration of the parameters is G16=1, G17=3, C01=0, C02=1.

Modulating compressors are connected to the *Compressor 1* analogue output, the enable signal of the first compressor to the *Compressor 1* digital output, that of the second one to the *Compressor 2* digital output and that of the third one to *Compressor 3*.

The graph refers to fixed rotation of the compressors (C03 = 1 or 3). For the sake of brevity, the case is illustrated in cooling mode only.

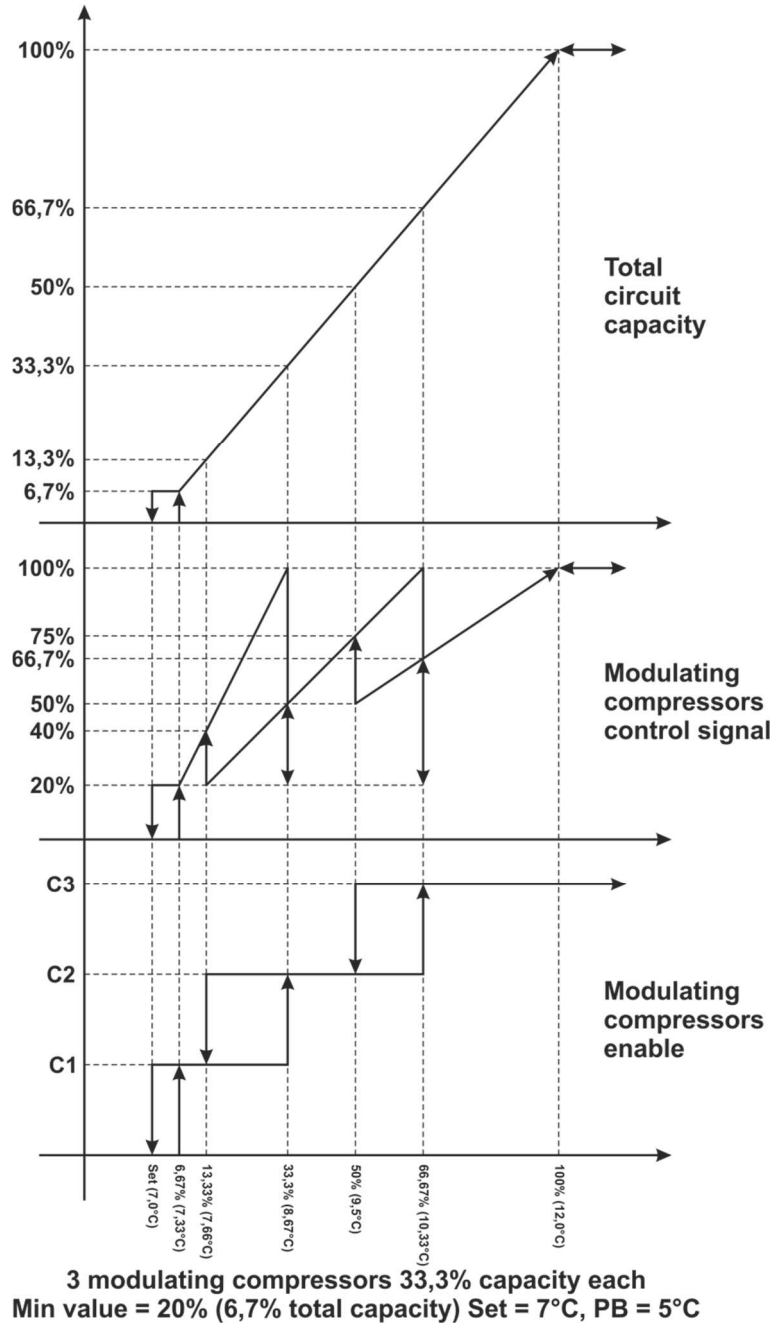

9.4.3 Dual-circuit controls

9.4.3.1 Dual-circuit with 1 ON/OFF compressor per circuit (balancing and saturation)

As regards control, this case is the same as that of a single circuit with 2 compressors. The compressors of circuit 1 and circuit 2 are controlled as 2 power steps.

The configuration of the parameters is G16=2, G17=1, C01=0, C02=0.

The compressor of circuit 1 is connected to the *Compressor 1* digital output and the compressor of the second circuit is connected to the *Compressor 4* digital output.

In this case, the choice of compressor is the same for both balancing and saturation.

The graph refers to fixed rotation of the compressors (C03 = 1 or 3).

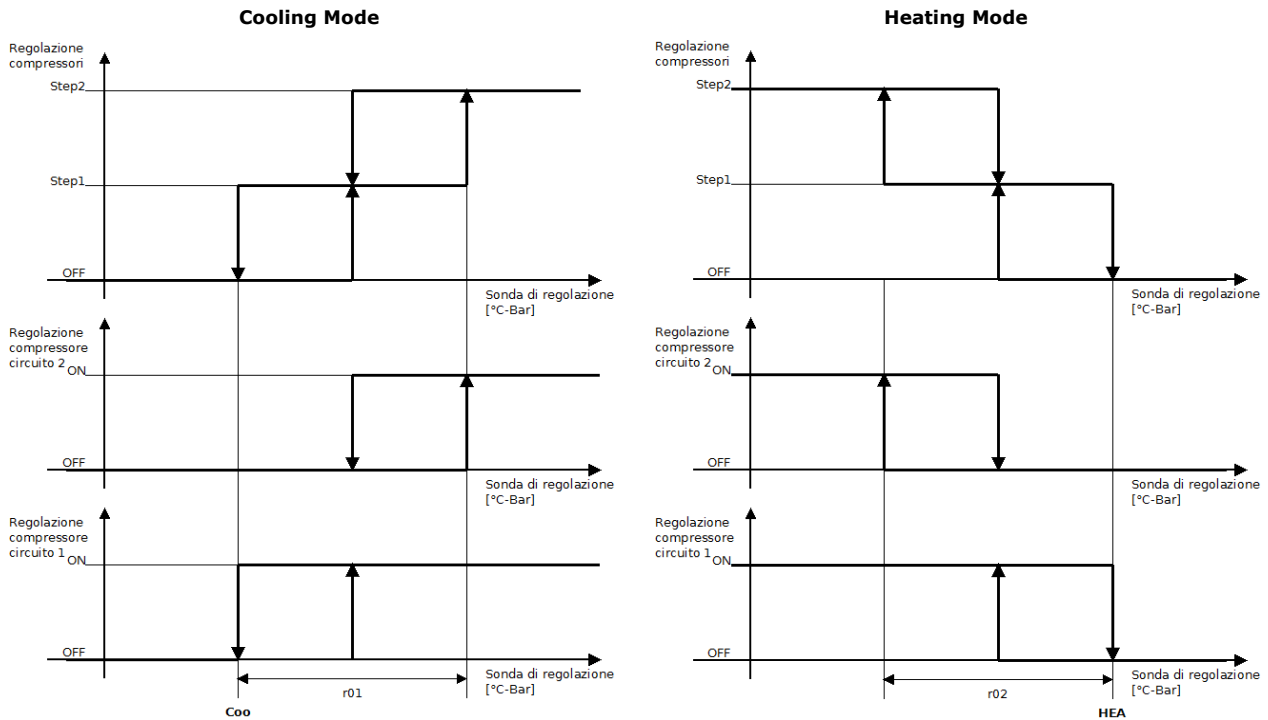

9.4.3.2 Dual-circuit with 6 ON/OFF compressors (balancing)

In this case the compressors (up to 6) are activated in sequence, trying to keep the power generated by the two circuits as balanced as possible.

The configuration of the parameters is G16=2, G17=3, C01=0, C02=0, C03=3.

The compressors of the first circuit are connected to the *Compressor 1*, *Compressor 2* and *Compressor 3* digital outputs; the compressors of the second circuit are connected to the *Compressor 4*, *Compressor 5* and *Compressor 6* digital outputs.

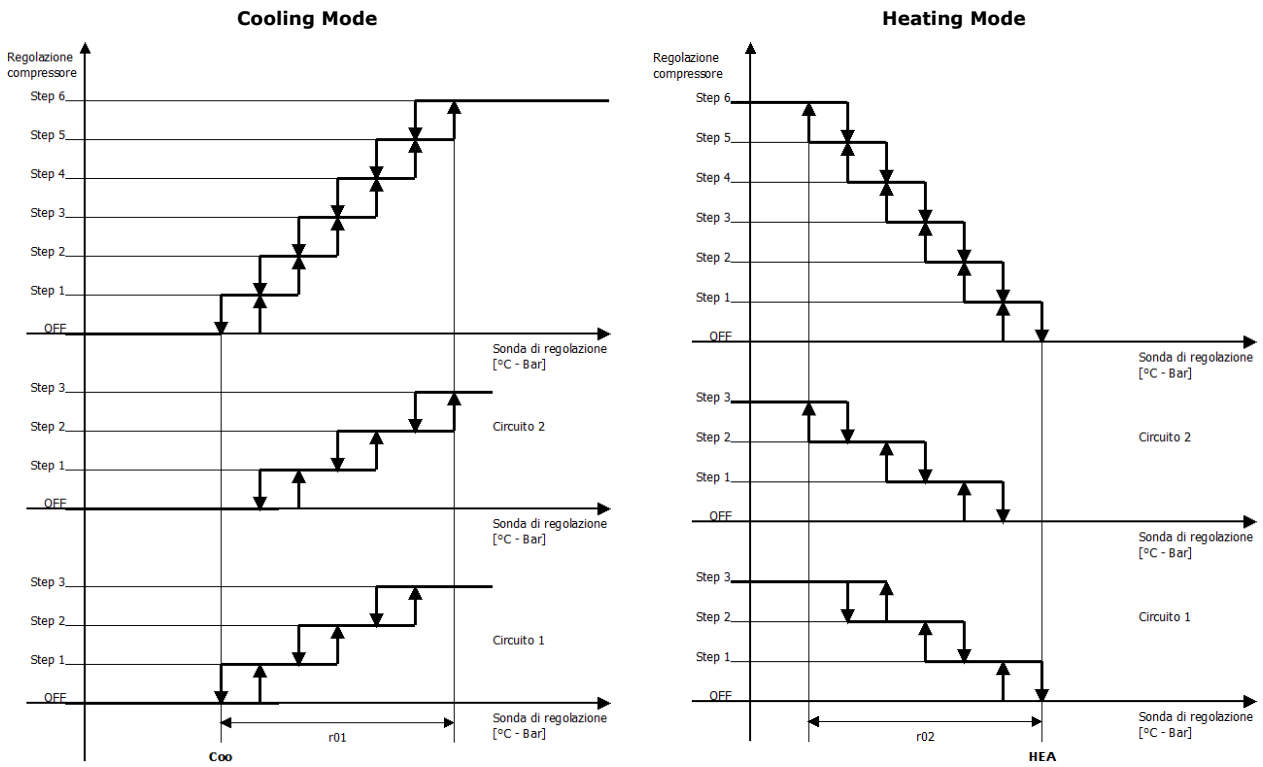

9.4.3.3 Dual-circuit with 6 ON/OFF compressors (saturation)

In this case the compressors (up to 6) are activated in sequence, saturating the first activated circuit before activating the second one. The configuration of the parameters is G16=2, G17=3, C01=0, C02=0, C03=3.

The compressors of the first circuit are connected to the *Compressor 1*, *Compressor 2* and *Compressor 3* digital outputs; the compressors of the second circuit are connected to the *Compressor 4*, *Compressor 5* and *Compressor 6* digital outputs.

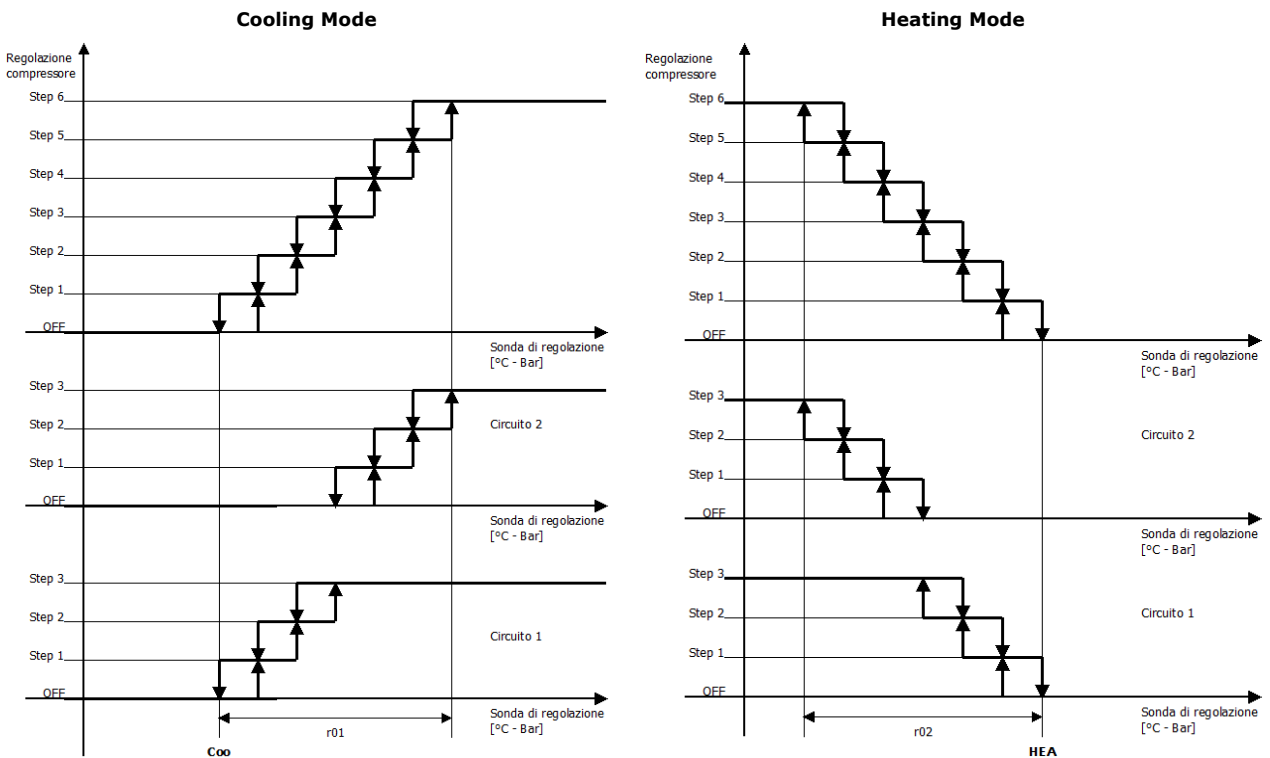

9.4.3.4 Dual-circuit with 1 modulating compressor per circuit (balancing and saturation)

In this case the compressor of the first circuit is switched on and brought to maximum capacity before switching on the compressor of the second circuit.

The configuration of the parameters is G16=2, G17=1, C01=0, C02=1, C03=1 or 3.

The modulating compressor of the first circuit is connected to the *Compressor 1* analogue output and its enable signal to the *Compressor 1* digital output; the modulating compressor of the second circuit is connected to the *Compressor 2* analogue output and its enable signal to the *Compressor 4* digital output.

The graph refers to fixed rotation of the compressors (C03 = 1 or 3). For the sake of brevity, the case is illustrated in cooling mode only.

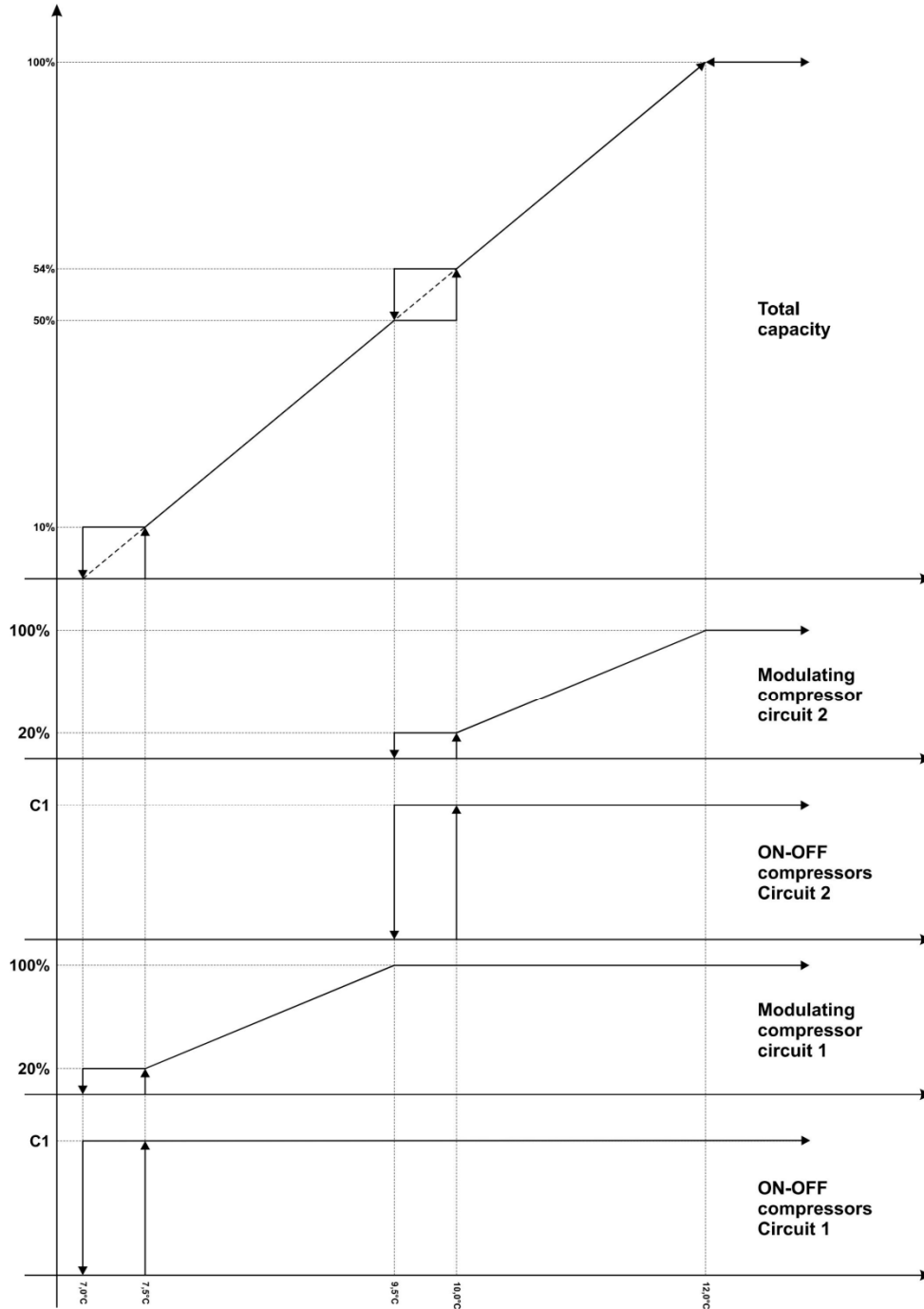

1 modulating compressor = 50% total capacity per circuit
Min value Mod Compr = 20% (10% total capacity) Set = 7°C, PB = 5°C

9.4.3.5 Dual-circuit with 1 modulating compressor and 2 ON/OFF compressors per circuit (balancing)

The compressors of circuit 1 and 2 are switched on/off alternately (starting with the 2 modulating compressors) to keep the total capacity generated by the compressors as linear as possible when the reference value varies and keep the power generated by the two circuits as balanced as possible. The configuration of the parameters is G16=2, G17=3, C01=0, C02=2, C03=3.

The modulating compressor of the first circuit is connected to the *Compressor 1* analogue output, its enable signal to the *Compressor 1* digital output and the On/Off compressors to the *Compressor 2* and *Compressor 3* digital outputs; the modulating compressor of the second circuit is connected to the *Compressor 2* analogue output, its enable signal to the *Compressor 4* digital output and the On/Off compressors to the *Compressor 5* and *Compressor 6* digital outputs.

The graph refers to fixed rotation of the compressors (C03 = 1 or 3). For the sake of brevity, the case is illustrated in cooling mode only.

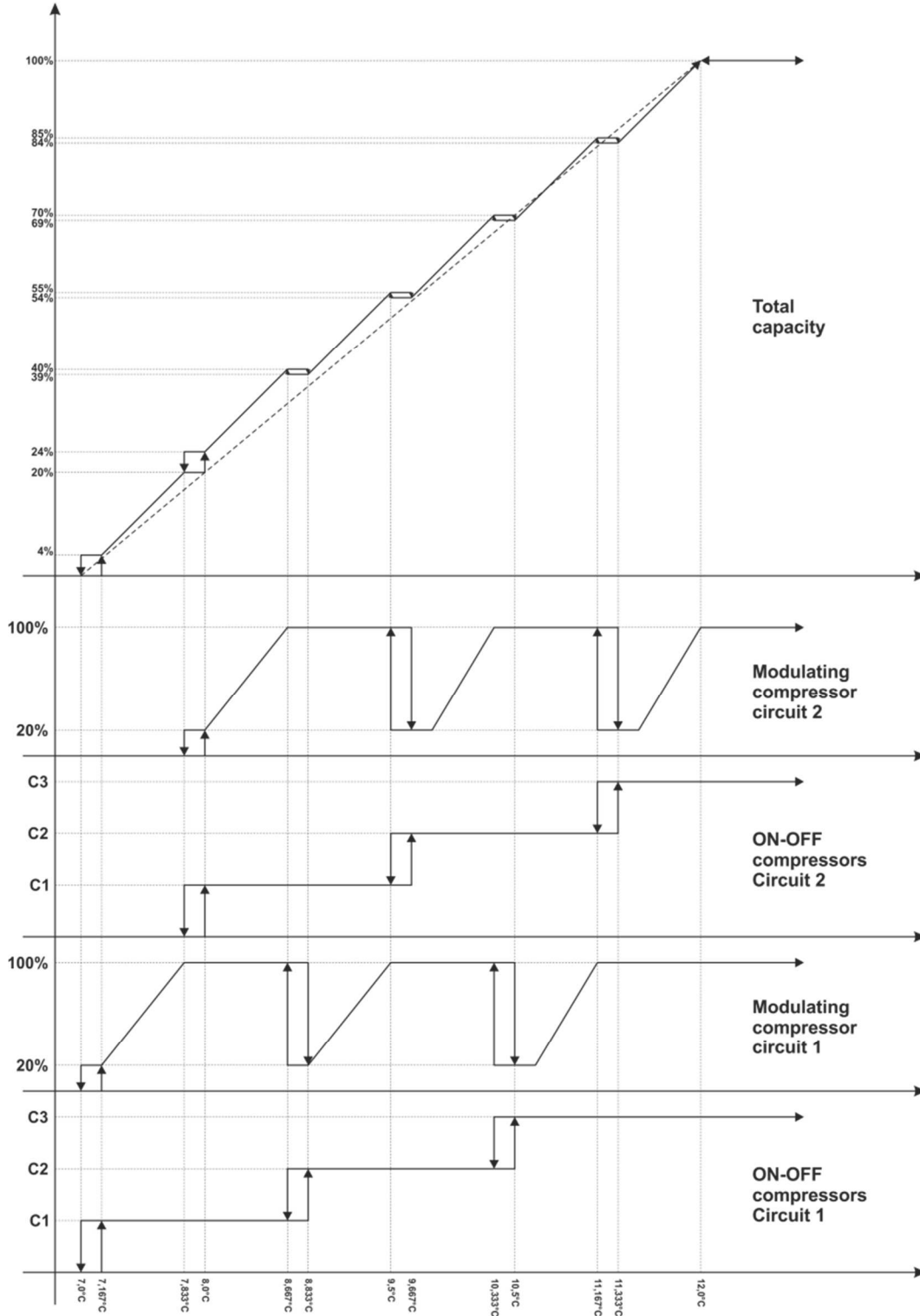

**1 modulating compressor + 2 ON-OFF compressors per circuit (1/6 capacity each)
Min value Mod Compr = 20% Set = 7°C, PB = 5°C**

9.4.3.6 Dual-circuit with 1 modulating compressor and 2 ON/OFF compressors per circuit (saturation)

All the compressors of circuit 1 are switched on (starting with the 2 modulating compressors) before starting those of circuit 2 in order to keep the total power generated by the compressors as linear as possible when the reference value varies. The principle is loading one circuit completely before switching on the second one.

The configuration of the parameters is G16=2, G17=3, C01=0, C02=2, C03=1.

The modulating compressor of the first circuit is connected to the *Compressor 1* analogue output, its enable signal to the *Compressor 1* digital output and the On/Off compressors to the *Compressor 2* and *Compressor 3* digital outputs; the modulating compressor of the second circuit is connected to the *Compressor 2* analogue output, its enable signal to the *Compressor 4* digital output and the On/Off compressors to the *Compressor 5* and *Compressor 6* digital outputs.

The graph refers to fixed rotation of the compressors (C03 = 1 or 3). For the sake of brevity, the case is illustrated in cooling mode only.

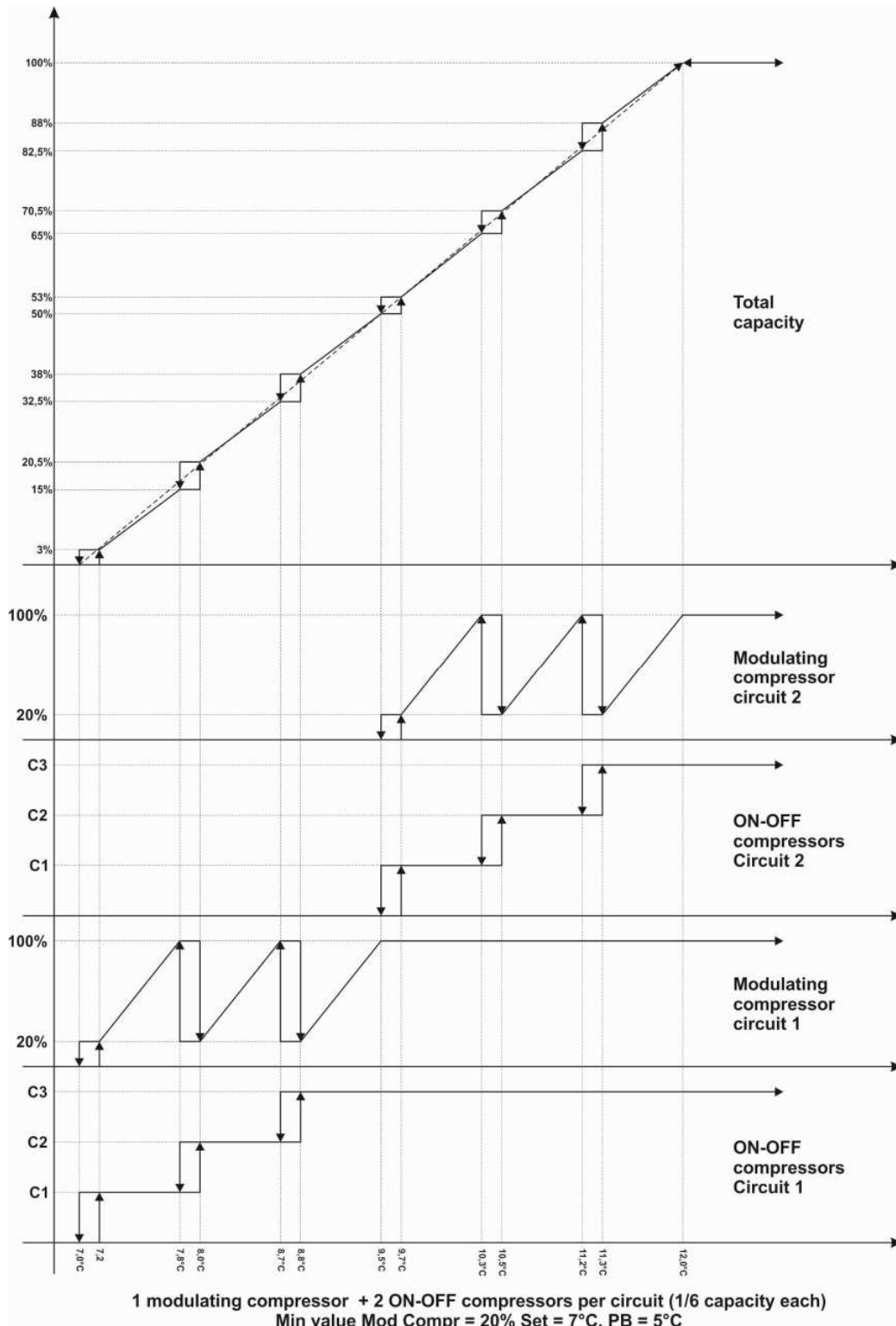

9.4.3.7 Dual-circuit 6 modulating compressors (balancing)

The compressors of circuits 1 and 2 are activated alternately.

When a compressor is activated, all the compressors of the circuit are brought to the start-up speed for the start-up time. Normal control resumes after this temporary phase.

The configuration of the parameters is G16=2, G17=3, C01=0, C02=1, C03=3.

The modulating compressors of the first circuit are connected to the *Compressor 1* analogue output and the enable signals to the *Compressor 1*, *Compressor 2* and *Compressor 3* digital outputs; the modulating compressors of the second circuit are connected to the *Compressor 2* analogue output and the enable signals to the *Compressor 4*, *Compressor 5* and *Compressor 6* digital outputs.

The graph refers to fixed rotation of the compressors (C03 = 1 or 3). For the sake of brevity, the case is illustrated in cooling mode only.

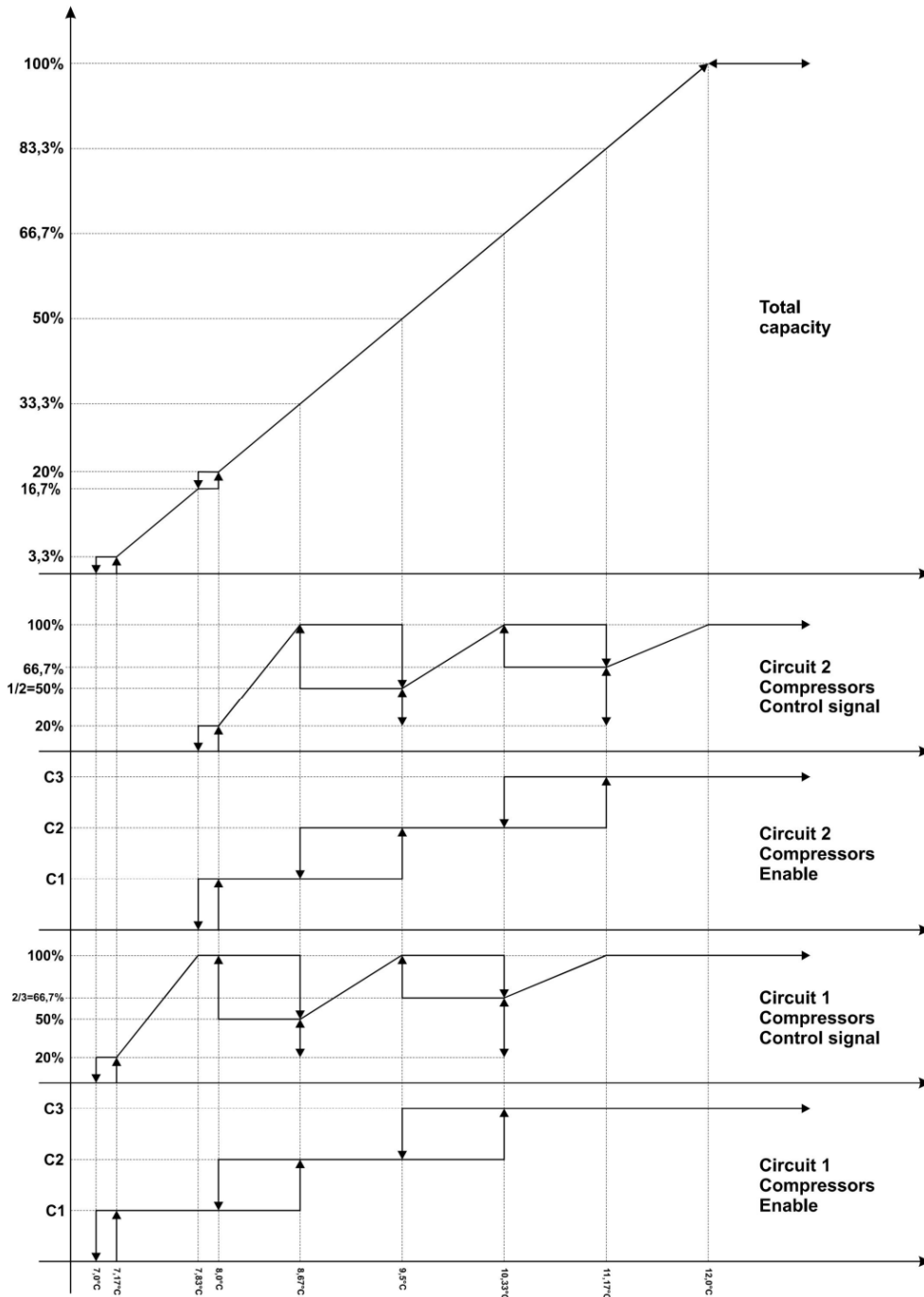

**3 modulating compressor = 16,7% total capacity (33,3% circuit capacity) each per circuit
 Min value Mod Compr = 20% (3,3% total capacity, 6,7% circuit capacity) Set = 7°C, PB = 5°C
 Circuits capacity BALANCING**

9.4.3.8 Dual-circuit 6 modulating compressors (saturation)

In this case the compressors of circuit 1 are activated first and only afterwards those of circuit 2.

When a compressor is activated, all the compressors of the circuit are brought to the start-up speed for the start-up time. Normal control resumes after this temporary phase.

The configuration of the parameters is G16=2, G17=3, C01=0, C02=1, C03=1.

The modulating compressors of the first circuit are connected to the *Compressor 1* analogue output and the enable signals to the *Compressor 1*, *Compressor 2* and *Compressor 3* digital outputs; the modulating compressors of the second circuit are connected to the *Compressor 2* analogue output and the enable signals to the *Compressor 4*, *Compressor 5* and *Compressor 6* digital outputs.

The graph refers to fixed rotation of the compressors (C03 = 1 or 3), for the sake of brevity only the case in cooling mode is given.

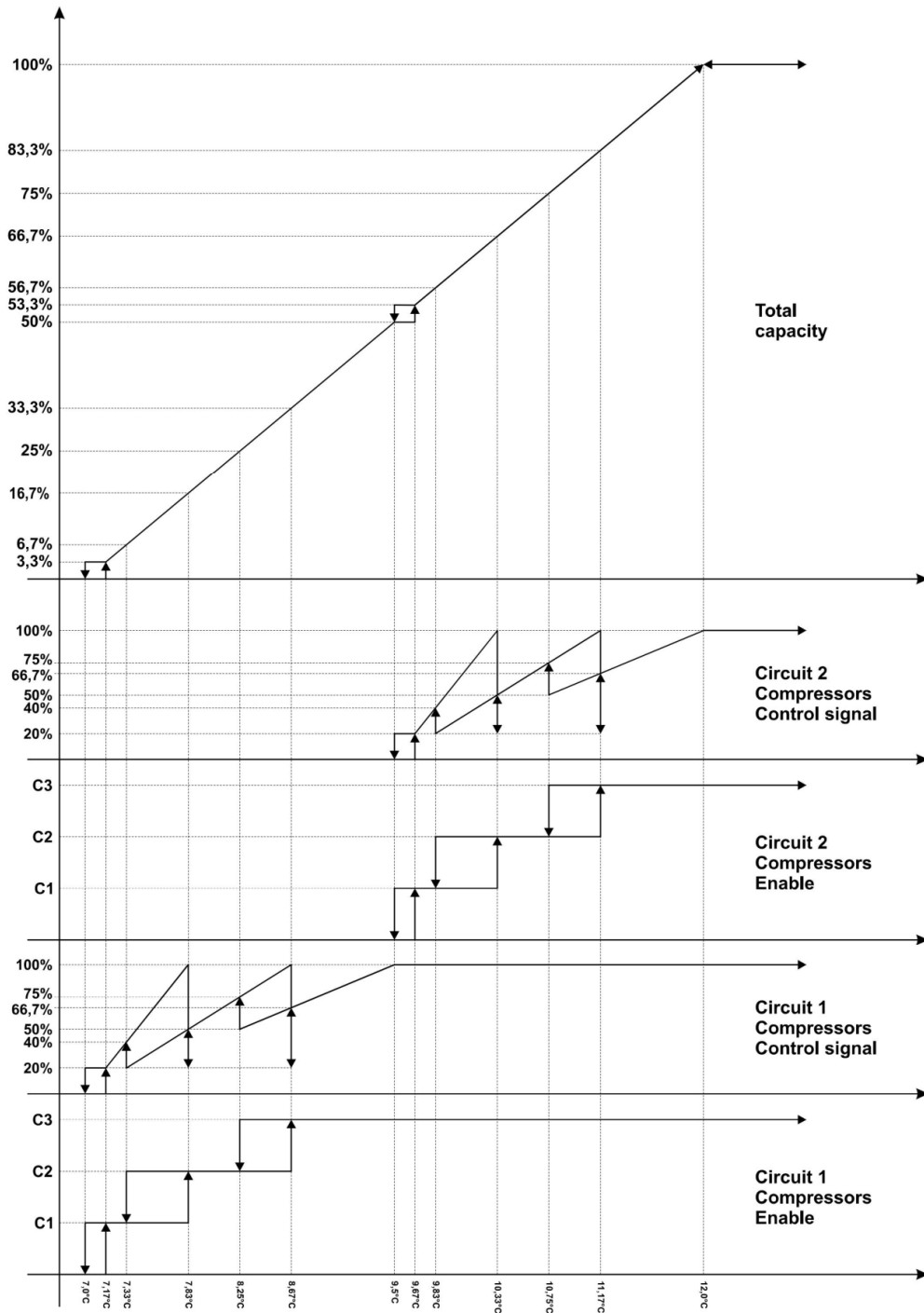

**3 modulating compressor = 16,7% total capacity (33,3% circuit capacity) each per circuit
 Min value Mod Compr = 20% (3,3% total capacity, 6,7% circuit capacity) Set = 7°C, PB = 5°C
 Circuits capacity SATURATION**

9.4.4 Remote control

If the machine does not have its own control function but is controlled externally (for example a condensing unit controlled by one or more internal units), it is possible to establish up to 6 digital inputs or one (1) analogue input for this purpose.

9.4.4.1 Control using digital inputs

If at least one digital input is configured as *Thermostat step N*, the compressor operates on request based on the digital input(s) and the control probe is not taken into consideration.

A digital input of the *Thermostat step x* type must be configured for every compressor in the machine.

Capacity steps should be activated in the following sequence:

Thermostat step 1-> *Thermostat step 2*-> *Thermostat step 3*->*Thermostat step 4*-> *Thermostat step 5*-> *Thermostat step 6*

Capacity steps are disabled in the following sequence:

Thermostat step 6-> *Thermostat step 5*-> *Thermostat step 4*->*Thermostat step 3*-> *Thermostat step 2*-> *Thermostat step 1*

For example, if *Thermostat step 1*, *Thermostat step 2* and *Thermostat step 4* are active, two power steps are activated, as *Thermostat step 3* is not active.

Only ON-OFF compressors can be controlled in this way.

9.4.4.2 Control with analogue input (0-10 V / 4-20 mA)

If no digital input is configured as *Thermostat step 1*, I01 should be configured as *Remote control* and one of the analogue inputs as *Remote control input*. The number of steps to activate is calculated according to the value of the *Remote control input*.

The *Remote control input* can be 0-10 V or 4-20 mA. The value of the control probe is calculated using the limits set by parameters I26-I33.

If the *Remote control input* is not correctly configured a configuration alarm occurs.

The graphs below refer to a machine with 6 compressors.

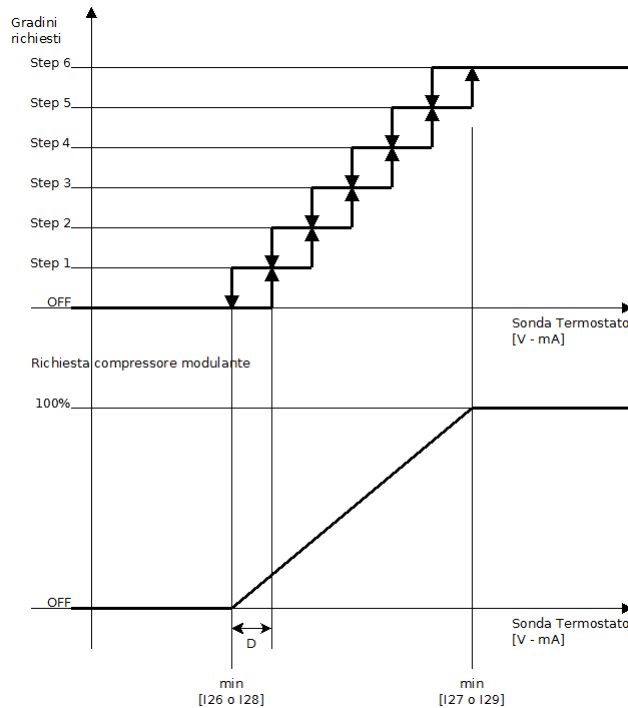

9.4.5 Oil recovery

If a modulating compressor remains active with a capacity lower than A26 for longer than A27, the oil recovery alarm (AOi1 and AOi2) is activated and all the compressors in that circuit are switched off. The alarm only stops when the power requested by this circuit exceeds 90%, enabling the compressor to operate again at a speed that is fast enough to ensure oil return.

9.4.6 Dynamic setpoint

The controller can change the working setpoint by adding to the setpoint (Coo or HEA) a value (Offset setpoint) which depends on the external temperature probe readout.

The function is active if G23 = 1 and a probe is configured as the *External temperature probe*.

The parameters involved are:

- Offset r09 in cooling mode and r10 in heating mode
- Setpoint r11 in cooling mode and r12 in heating mode
- Delta r13 in cooling mode and r14 in heating mode

The graphs below illustrate the different combinations of parameters:

Offset > 0 and Delta > 0

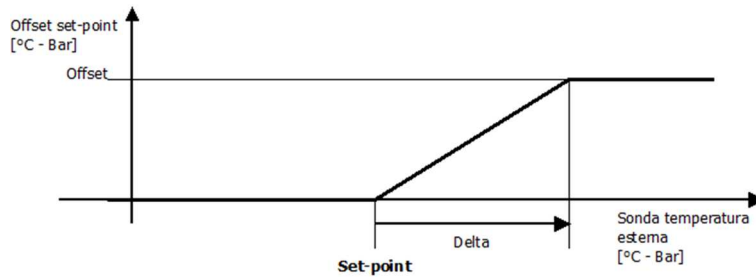

Offset > 0 and Delta < 0

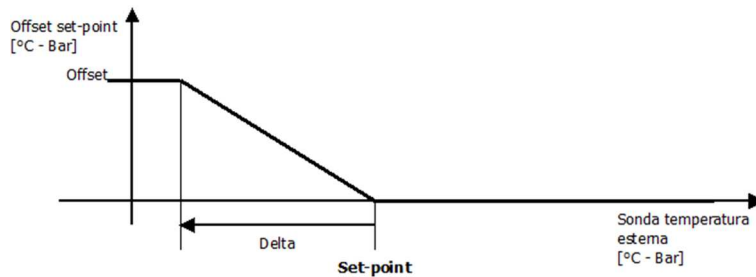

Offset < 0 and Delta < 0

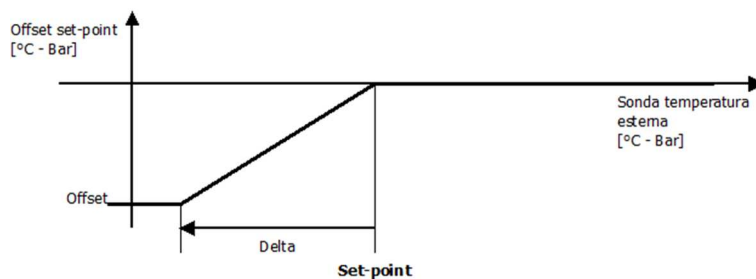

Offset < 0 and Delta > 0

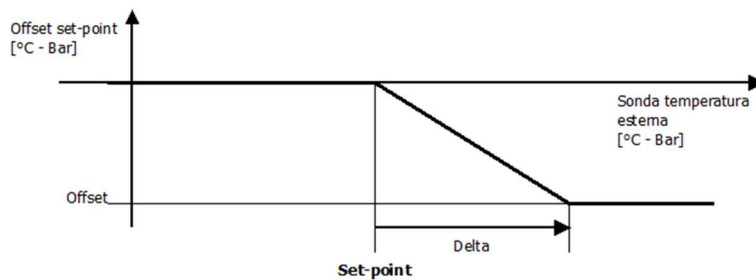

9.4.7 Solenoid valve

The *Solenoid valve circuit 1/2* digital output should be configured for enabling the function.

If parameter G18 = 0 and the *Evaporating probe circuit 1/2* is configured and not in error mode, control depends on the value of the evaporating pressure: waiting time DT1 is the time the pressure takes to exceed the value r15 + A04, while time DT2 is the time it takes to go below r15.

If parameter G18 is different to 0 or if the evaporating probe has not been configured or if it is in alarm mode, control is based on timeout:

if parameter G18 is greater than 0, the function is time-controlled with DT1 = DT2 = G18

if parameter G18 is lower than 0, the function is time-controlled with DT1 = G18 and DT2 = 0.

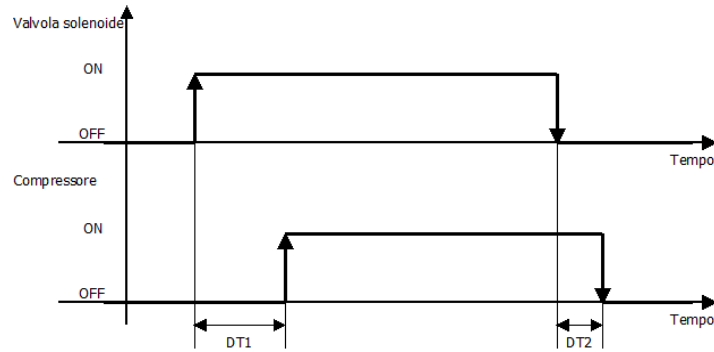

9.5 Hot gas bypass

This type of control is used with precision chillers where control of the water supply temperature should be extremely accurate using a hot gas bypass valve on circuit 1. This function needs some configurations to take place for being used:

- there must be an AO/TK-OC/DO output to control the HGBP (hot gas bypass) valve
- a supply probe must be fitted and not in alarm.

This function works in cooling mode only and only if the compressors are switched on.

When the algorithm starts up, the HGBP valve is brought to position r31 for a period of r30 seconds. After this time and setting an integral time other than 0, the HGBP valve will gradually return to the correct position, determined by the algorithm explained below.

After this transitory condition the HGBP valve operates according to the following logic:

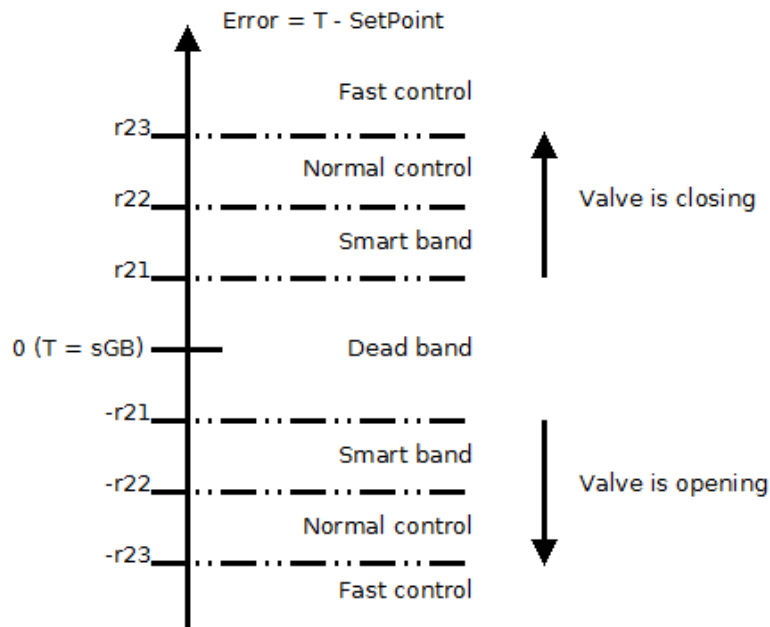

Inside the dead band the position of the HGBP valve does not change. In the Smart band, only integral and derivative time are used to gradually bring the error back under control. During Normal control, a classic PID is used, while in the Fast control one tries to reduce the error faster multiplying the proportional band (r24) by the coefficient "fast action" (r27) thus increasing the action of the algorithm. The configuration parameters of the PID algorithm are from r24 to r26

r27 is a correction parameter for speeding up the control function when the error is too high. r27 = 100 corresponds to no correction, r27=1 corresponds to maximum correction.

A period (in seconds) is defined for PWM HGBP valve management (parameter r32) and the PID algorithm defines its duty cycle. For example, if the output of the algorithm is 50% and the period is 10 seconds, the valve will remain open for 5 seconds and closed for a further 5 seconds.

If an analogue output is used, parameter r33 defines the output voltage when it is active. Restricting the output voltage is useful to limit the current generated (max. 10 mA) by the analogue output if it is used to control an SSR which, in turn, controls the hot gas bypass valve.

If the *Discharge probe compressors circuit 1* or the *Discharge probe compressor 1* has been configured, the high discharge temperature is actively controlled: if the temperature raises above the r28 threshold, the control algorithm is suspended and the HGBP valve closed. The algorithm starts working again when the temperature drops below the r28-r29 threshold.

9.6 System pump

9.6.1 Initial information

The operating mode of the hydraulic pump is configured by parameter P01: the pump may be always ON or can be activated upon temperature control.

In the second case, the pump switches off after a delay of P03 from compressor switch off every time it is deactivated by the controller. It will switch off immediately if an alarm requiring the pump to be stopped, such as the flow alarm occurs.

From the pump activation the flow switch status is neglected for a period equal to A09 to ensure the water flow is stable, during that period the flow alarm is not active. For sake of safety during that period the compressors are disabled. Once A09 is over the compressors are still disabled for a further period equal to P02. The delay from pump activation to compressors enable is thus $A09+P02$.

9.6.2 Operation

The hydraulic pump can be set to operate in the following modes:

Continuous The pump is always in ON mode if $P01 = 0$

On request The pump is switched on at the request of the temperature control if $P01 = 1$. The compressor is activated with a delay (P02) from pump switch-on and the pump is switched off with a delay (P03) from the compressor switch off, as shown below:

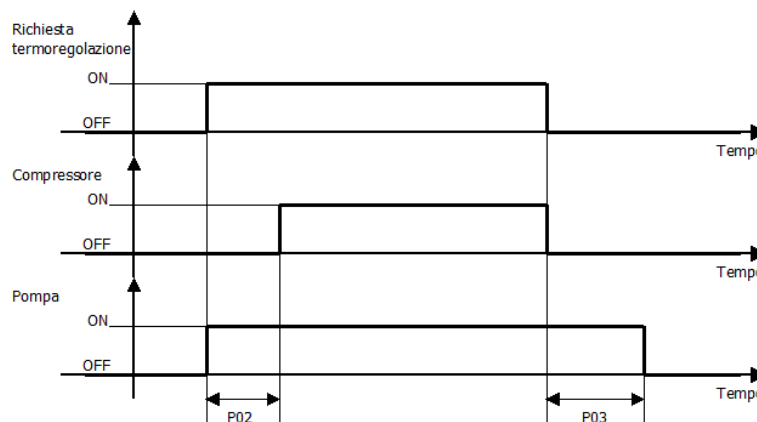

9.6.3 ON/OFF operation

If an ON/OFF pump is to be used, it must be connected to an output which is configured as a digital output (I54 - I69) configured as the *System pump*.

9.6.4 Modulating operation

If a modulating pump is to be used, it must be connected to an analogue output (AO1 or AO2) configured as the *System pump*.

In this case the pump speed is controlled proportionally to the absolute value of the difference between the *Input water probe* and the *Output water probe* values which must be correctly configured and not in alarm.

Pump modulation varies from a minimum, set by parameter P06, to 100%. The pump maintains the P06 value until the setpoint has been reached, after which the speed increases linearly up to 100% within a control band which is set by parameter P08.

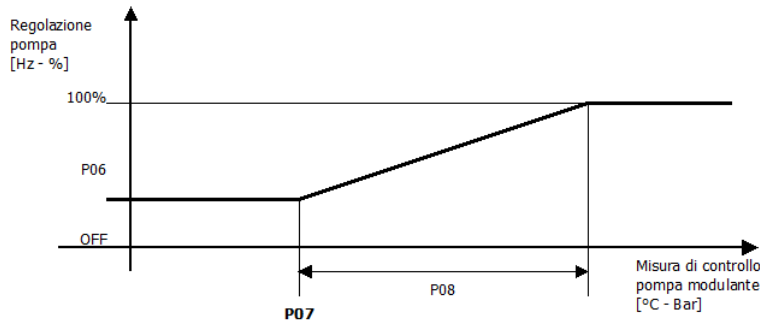

9.6.5 Antifreeze operation

When the temperature of the input or output water is below P04, the pump starts if it is off. The pump switches off when the temperature rises above the antifreeze threshold value plus hysteresis (P05). The diagram below shows this.

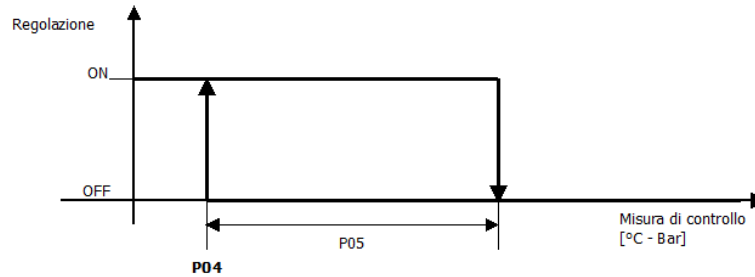

9.7 System electrical heating elements

9.7.1 Initial information

The digital output which controls the electrical heating elements may also be used to enable a boiler.

When in integration mode, the system heating element output is only activated if the machine is in heating mode, if G20 = 1 and if there is an output configured as the *System heating element*.

The heating elements start when the temperature of the control probe drops below the threshold set by parameter HEA - H07 - H05 for a time period of H06. They switch off when the temperature rises above the threshold set by (HEA - H07). If the compressor is in alarm mode, the adjustment is made without delay from when the HEA setpoint is reached.

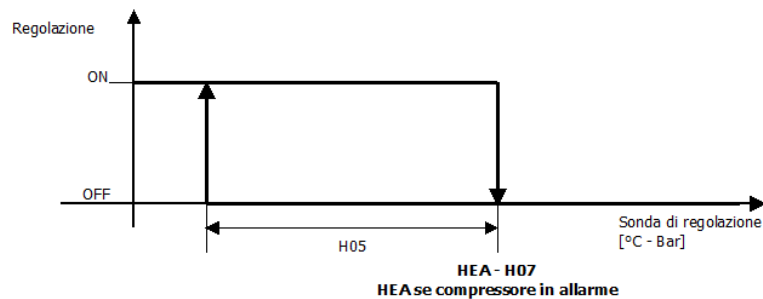

9.7.2 Heating elements in antifreeze mode

The heating element starts when the pump is switched on and when the minimum temperature between the input and output water is lower than the parameter H02 with hysteresis H05.

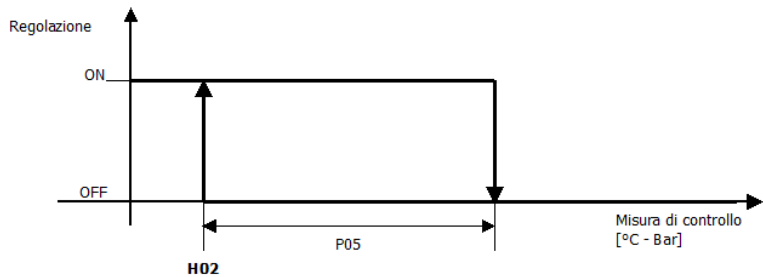

10 Ventilation Control

10.1 Initial information

The condensing temperature/pressure (in cooling mode) and the evaporating temperature/pressure (in heating mode) are controlled modulating the ventilation that can either be proportional or ON/OFF in steps.

The maximum number of fan speed steps is 4; single circuit units may have 4 speed steps for circuit 1, whereas dual-circuit units may have a maximum of 2 steps per circuit. The number of steps is defined when configuring the *Fans circuit 1/2* digital outputs.

The type of fan rotation is selected with parameter F20.

If a proportional adjustment fan is to be used, it should be connected to the *Fans circuit 1/2* analogue output. If an enable output is to be used for the modulating fan, it has to be connected to the *Fans circuit 1/2* digital output.

With modulating fans, the parameter F01 sets the start-up time only if the fan output is configured as phase cut (I49 = 1).

During post-ventilation, the fans remain on at a speed defined by F10 (cooling mode) or F11 (heating mode) for a period defined by F07 from the moment when the last compressor in the circuit was switched off.

During pre-ventilation (function available only in cooling mode), the fans switch on at a speed defined by F08 for a period defined by F06 before the first compressor in the circuit is switched on.

The fan can be adjusted independently of the compressor (F03=1) or at the request of the compressor (F03=0).

In cooling mode modalità the ventilation control depends on the maximum value between *Circuit 1/2 condensing probe and circuit 1/2 evaporating probe*. In heating mode it depends on the minimum value between *Circuit 1/2 condensing probe and circuit 1/2 evaporating probe*.



In normal operation (not in defrost) if the probe driving the ventilation is in error or not configured the fans work according to the compressor with speed 100% (all steps configured in case of this regulation); pre and post ventilation times are respected, both for modulating regulation and for steps regulation.

In post ventilation the fans are turned on at speed F12 (Cooling) or F13 (Heating) for the time F07 after the last compressor of the circuit has switched off.

In pre ventilation (this function is active only in cooling mode) the fans turn on at speed F12 for the time F06 before the first compressor of the circuit switches on.

10.2 Step control function

As far as step control function is concerned, modulation of the air flow to the coil is ensured by gradually activating the available fans, using from one to four correctly configured relays.

1 circuit with 1 - 4 fan steps

- for 1 step, configure Fans circuit 1 (step 1)
- for 2 steps, configure Fans circuit 1 (step 1) and Fans circuit 1 (step 2)
- for 3 steps, configure Fans circuit 1 (step 1), Fans circuit 1 (step 2) and Fans circuit 1 (step 3)
- for 4 steps, configure Fans circuit 1 (step 1), Fans circuit 1 (step 2), Fans circuit 1 (step 3) and Fans circuit 1 (step 4)

2 circuits with 1 - 2 fan steps: they may even be different to each other

- for 1 step, configure Fans circuit 1 (step 1)
- for 2 steps, configure Fans circuit 1 (step 1) and Fans circuit 1 (step 2)
- for 1 step, configure Fans circuit 2 (step 1)
- for 2 steps, configure Fans circuit 2 (step 1) and Fans circuit 2 (step 2)

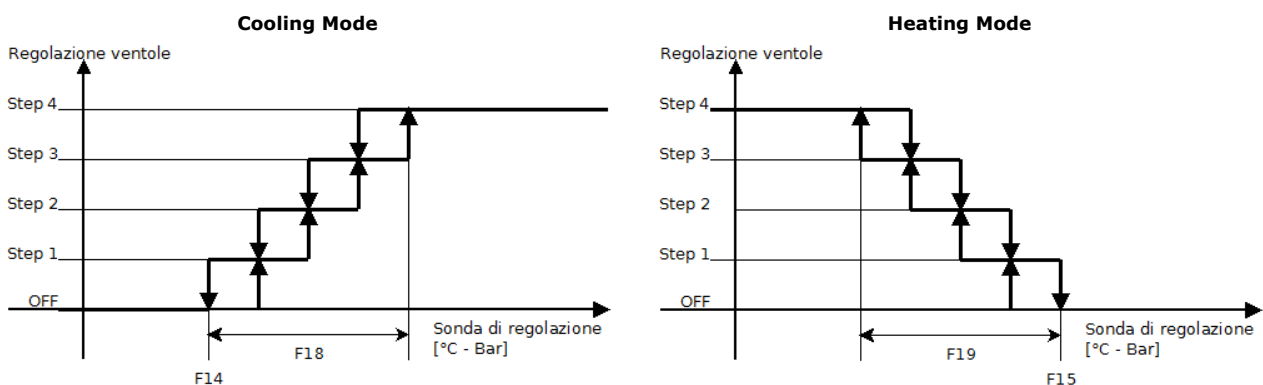

10.3 Modulating control function

In cooling mode, ventilation control depends on the maximum value between the *Condensing probe circuit 1/2* and the *Evaporating probe circuit 1/2*. In heating mode, on the other hand, it depends on the minimum value between the *Condensing probe circuit 1/2* and the *Evaporating probe circuit 1/2*. If the probe is in error mode, the fans will operate in parallel with the compressors, irrespective of the value of parameter F03.

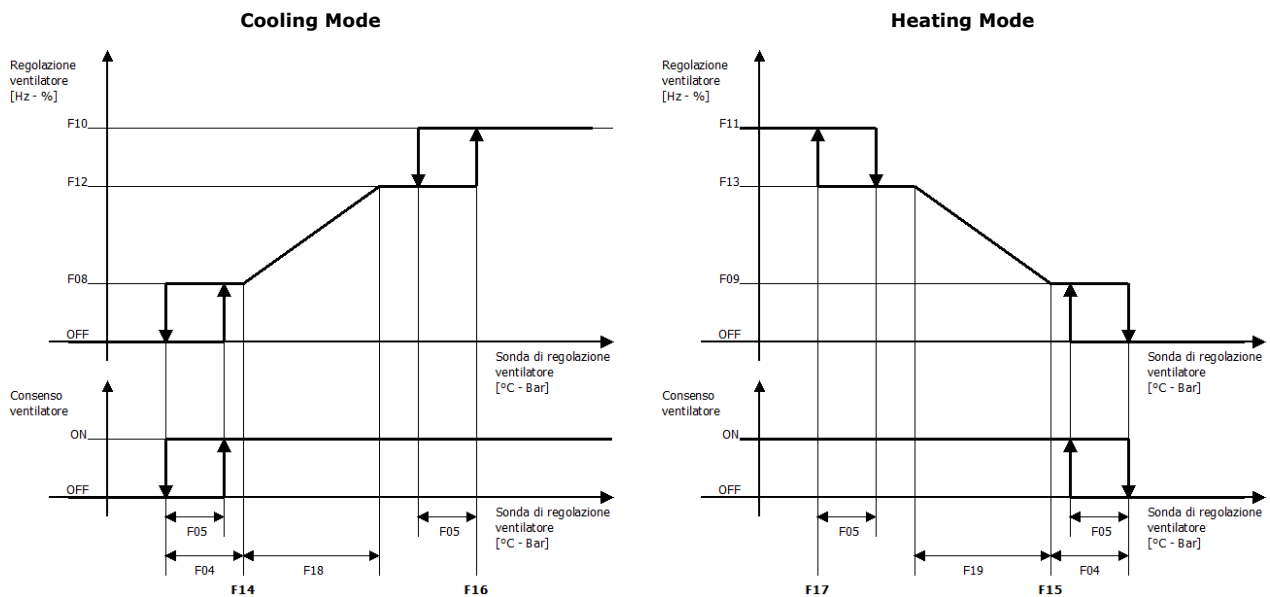

Parameter F14 in cooling mode (F15 in heating mode) represents the setpoint for the minimum speed of the fans, while F16 in cooling mode (F17 in heating mode) the setpoint for the maximum speed of the fans.

There is a cut-off set by parameter F05 which, depending on the speed of the fans, goes from OFF to F08 in cooling mode (F09 in heating mode) when the fans are at minimum speed and from F10 to F12 in cooling mode (from F11 to F13 in heating mode) when the fans are at maximum speed.

A delta cut-off (F04) delays the proportional adjustment in one direction and stops it in advance in the other. The duration of the proportional adjustment is set by band F18.

10.4 Capacity control during defrosting

As the defrost cycle is starting up, the fan remains off.

The graph below shows, instead, fan control when defrosting is in progress (with the compressor on).

The defrost activation setpoint is set by parameter d11, hysteresis is set by parameter d12 and fan speed (fixed) by parameter d13.

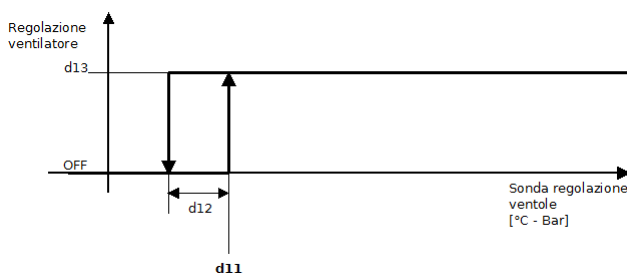

During dripping, the fan is first switched off and, when the 4-way valve has been reversed, it comes back on at maximum speed for a period of time set by d07.

11 Defrost

11.1 Initial information

The defrost function is only active if the system is in heating mode and enabled by the parameter d01.

d01 = 0 Defrost disabled

d01 = 1 Defrost with compressor active

d01 = 2 Defrost by compressor stop (as **d01 = 1** but without activating the compressors)

d01 = 3 Timed defrost (as **d01 = 1** but end only for maximum time).

11.1.1 Start defrost control

The start defrost probe is the *Evaporating probe circuit 1/2*, if this probe is correctly configured and is not in error mode, otherwise it is the *Condensing probe circuit 1/2*. To run a defrost with compressors OFF parameter d01 must be set to 2.

When the probe reading is below the d02 threshold and the compressor is active, a counter is increased: when the count reaches the d03 value and the period of time d09 has elapsed since the last defrost, the defrost cycle starts. The count stops if the probe reading rises above the d02 threshold or if the compressor is switched off. If the value of the reference probe goes below the d08 value, defrost is forced (the counter is brought to 10 seconds).

Once the count has finished, defrost begins. The reversing valve turns after a delay equal to the time expressed by parameter d06 and the compressor is switched back on at full power after a further wait equal to the time expressed by the parameter d06, also with a switch-on waiting time of d10. If the probe value rises above d11, the fans are activated on full power; if it falls below d11-d12, the fans stop.

The diagram below shows the start defrost cycle.

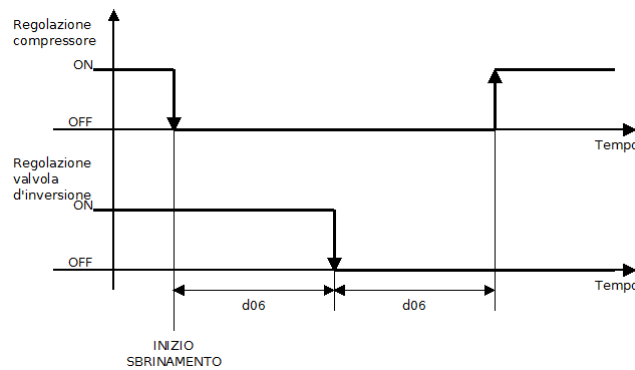

11.2 End defrost control

If parameter d01 is set to 1 or 2, the end of defrost depends on the reading of the *Coil probe circuit 1/2*, if configured, otherwise on the reading of the *Evaporating probe circuit 1/2* or the *Condensing probe circuit 1/2*. If the end of defrost control probe is in error mode, the machine exits defrost.

Defrost is interrupted when the reading of the probe rises above the d04 threshold or if the duration of the defrost is equal to d05.

If parameter d01 = 3, defrost is interrupted only when it lasts longer than d05.

Once the active defrost stage has finished, the compressor is switched off. The reversing valve is controlled and the fans are forced to maximum speed after a delay equal to the time expressed by parameter d07 and the compressor is switched back on at full power after a further wait equal to the time expressed by parameter d07.

The diagram below shows the end defrost cycle.

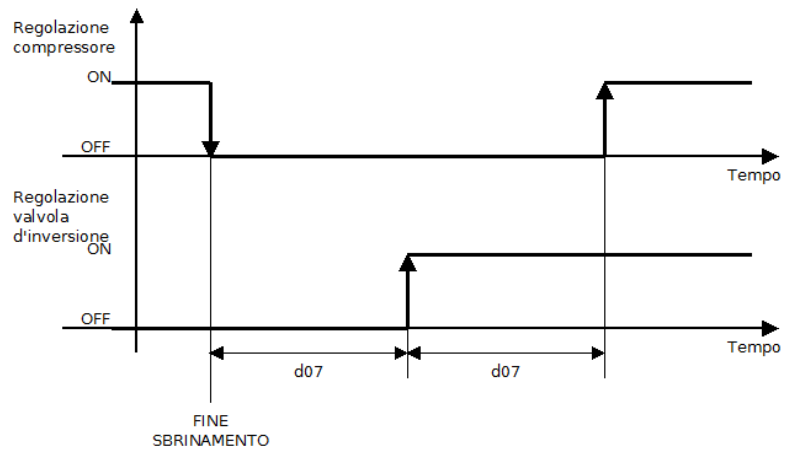

12 DOMESTIC HOT WATER (DHW)

12.1 Initial information

The domestic hot water function is active if fitted ($G15 = 1$), if a probe is configured as the *Domestic hot water probe* and if a relay is configured as the *Domestic hot water valve*.

The domestic hot water function is available if the user has selected it by setting control status S05 or by holding the DOWN key down.

The domestic hot water function is activated when the temperature of the domestic hot water drops below the dHU setpoint.

If the machine is in heating mode, it is forced to maximum power. When the temperature of the domestic hot water reaches the setpoint, the control function returns to "normal" (system water) but is based on the reading of the control probe before entering DHW mode. Once the equivalent period of r17 has elapsed, the control function returns to being based on the effective value of the control probe. This function controls the delay of the domestic hot water which would immediately cause compressor switch-off due to the setpoint being reached.

If the machine is in cooling mode, it switches off and comes back on as the heat pump at maximum power, respecting its safety time. When the DHW setpoint is reached, the machine switches off and comes back on in cooling mode.

The defrost function is active when DHW is active in CHILL/HPRU. The domestic hot water valve is closed when defrost is active.

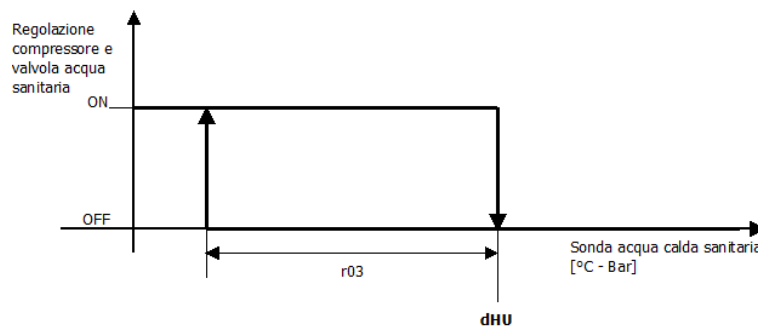

During switching of the DHW valve (parameter S11), the compressors are forcibly switched off. During this phase, reversing valve switching occurs if necessary.

The domestic hot water valve is closed when defrost is active.

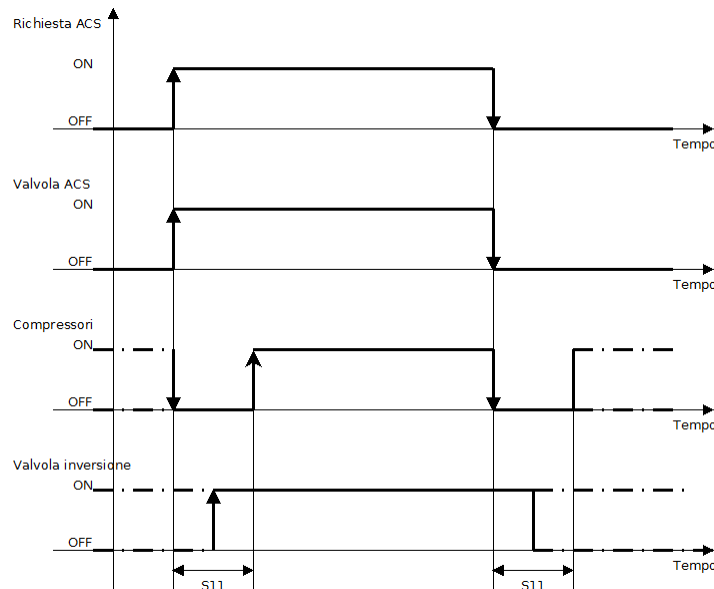

12.2 Anti-legionella function

Anti-legionella mode is set by parameter G25: if it is different to 0, the function is active. Furthermore, if the parameter is set to 2, a cycle is programmed for when the machine is switched on.

The next anti-legionella cycle is programmed when the delay set by parameter r20 elapses and corresponds with holding of the domestic hot water at a temperature that is higher than the r18 setpoint for a period of time r19.

The r19 count is only decreased if the temperature is above r18.

The compressors are switched on if the temperature is below r18 and are switched off when it is above r18 + r03.

The compressors use the standard timings.

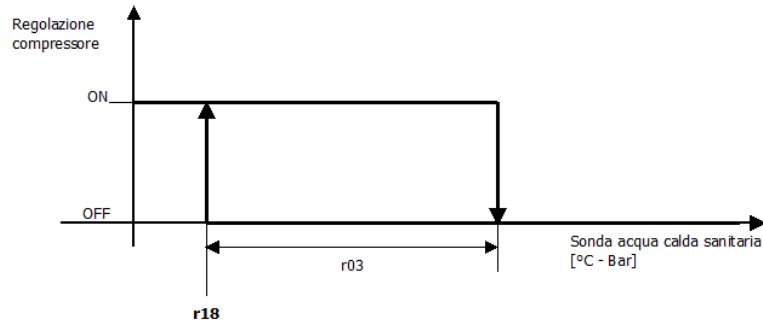

12.3 Boiler electric heating elements

The boiler heating element output is active in integration mode only if DHW mode (G15 = 1) is active and a digital output is configured as the boiler heating element. Adjustment is made on the *Domestic hot water probe*, the setpoint is Set ACS - r16, hysteresis is H05 and the activation delay is H06; if the compressors are in alarm mode, adjustment is made with setpoint setACS and with no delay.

The Set ACS may not be the setpoint of parameter dHU, but the solar panel or anti-legionella setpoint.

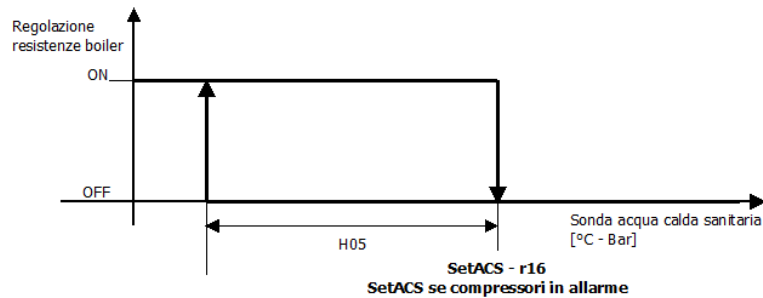

If the *Domestic hot water probe* detects a temperature below parameter H01, the boiler heating elements are automatically activated in antifreeze mode.

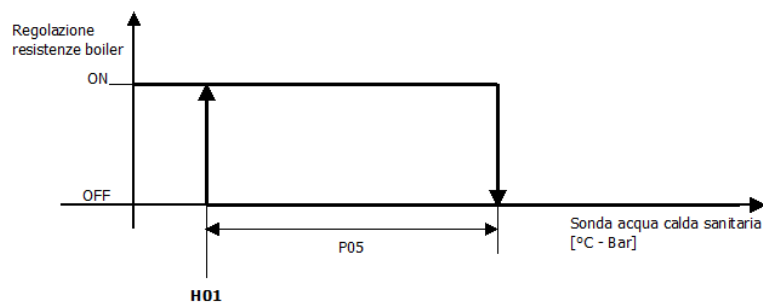

If G22 = 1 and both the boiler and the system heating elements have been requested, only one of the two resources is brought into use, depending on the availability of the DHW (G15 = 1 and DHW selected).

- If DHW is available, only the boiler is used,
- otherwise, only the system heating elements are used.

12.4 Solar Panels

To ensure the solar panel function works correctly, a probe must be configured as the *Solar panel manifold probe*, a probe as the *Solar panel storage probe* and a relay output as the *Solar panel pump*.

The pump is activated if the difference between the temperature of the manifold and that of the storage is greater than parameter S01.

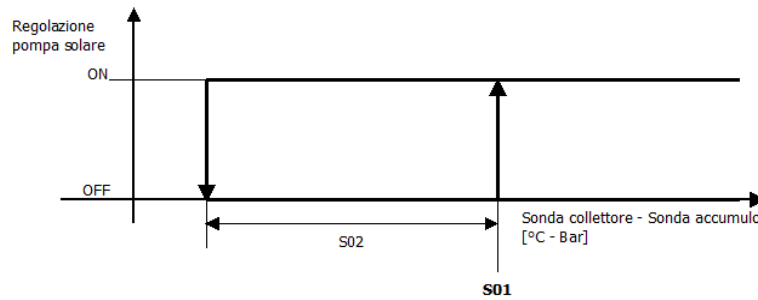

If the temperature of the manifold exceeds parameter S03, the valve output is switched on and off periodically with times which are set by parameters S04 and S05 according to the graph below:

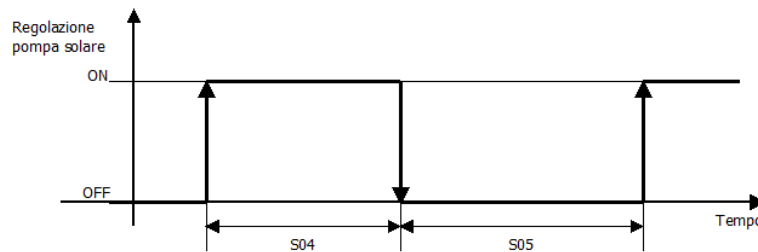

If the temperature of the domestic hot water exceeds parameter S09, the solar panel valve output is switched off. The function to protect the over-temperature of the manifold has priority over this function.

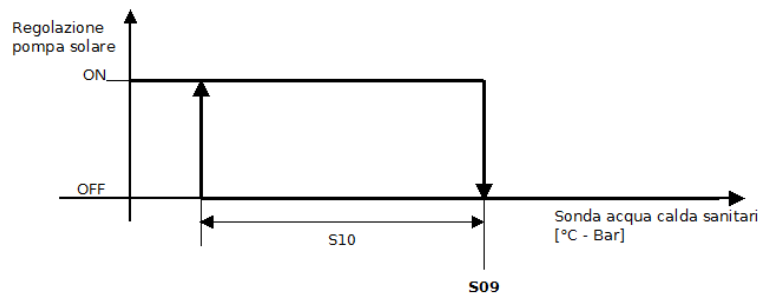

If the temperature of the manifold is below parameter S06, the valve is activated in antifreeze mode.

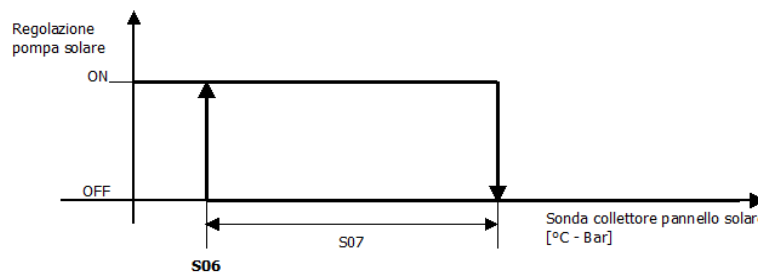

If a digital input is configured as *Solar*, it signals energy is available when the input is active. In this case the DHW setpoint used is the one set in parameter S08.

13 INTERNAL STATUSES

States table

specific values for the temperature probes:

3276.4: Disabled

-3276.8: Err

specific values for the pressure probes:

327.64: Disabled

-327.68: Err

Specific analogue output values

- 1: Disabled

Digital input and output values

- 1: Disabled

0: OFF

1: ON

Label	Heat pump visibility default value	Chiller visibility default value	Min	Max	Unit of measurement	Description
S01	U	U	0	2		Unit status 0: ON 1: Stand-by 2: Stand-by from digital input
S02	U	U				Alarm in progress 0: OFF 1: ON
S03	U	U				Control probe -3276.8: probe error
S04	U	U			°C;°F;Bar; psi*10	Setpoint in use
S05	U	U	0	4		Operation mode 0: HPRU 1: HPRU + DHW 2: CH 3: CH + DHW 4: DHW
S06	U	U				DHW status 0: OFF 1: ON 2: Anti-legionella
S07	U	U			s	Anti-legionella holding time
S08	U	U			days	Anti-legionella delay
S09	U	U			%	Request for temperature control
S10	U	U				Steps in operation
S11	U	U				Compressor switch-on counter delay from pump switch-on
S12	U	U				Pump switch-off counter delay from compressor switch-off

Label	Heat pump visibility default value	Chiller visibility default value	Min	Max	Unit of measurement	Description
S13	U	U				Hot gas bypass valve status 0: Initialisation 1: Start-up 2: Control 3: Stop
S14	U	U			%	Percentage hot gas bypass valve
Hour						Hours of operation
S15	U	U			h*10	Compressor 1 operating hours
S16	U	U			h*10	Compressor 2 operating hours
S17	U	U			h*10	Compressor 3 operating hours
S18	U	U			h*10	Compressor 4 operating hours
S19	U	U			h*10	Compressor 5 operating hours
S20	U	U			h*10	Compressor 6 operating hours
S21	U	U			h*10	Pump operating hours
S22	U	U			h*10	Unit operating hours
S23	U	U			h*10	Fan 1 operating hours
S24	U	U			h*10	Fan 2 operating hours
S25	U	U	0	0	h*10	Fan 3 operating hours
S26	U	U	0	0	h*10	Fan 4 operating hours
Circ						Circuit status
S27	U	U				Steps in operation Circuit 1
S28	U	U				Defrost status Circuit 1
S29	U	U			s	Defrost timer Circuit 1
S30	U	U			%	Request fans Circuit 1
S31	U	U				Steps in operation Circuit 2
S32	U	U				Defrost status Circuit 2
S33	U	U				Defrost timer Circuit 2
S34	U	U			%	Request fans Circuit 2
CoMP						Compressor status
S35	U	U			Min	Delay between defrosts
S36	U	U			s*10	Counter time between switch-off of different compressors
S37	U	U			s*10	Counter time between activations of different compressors
S38	U	U			s*10	Counter delay compressor unloader activation

Label	Heat pump visibility default value	Chiller visibility default value	Min	Max	Unit of measurement	Description
S39	U	U				Circuit Compressor 1 0: Disabled 1: Circuit 1 2: Circuit 2
S40	U	U				Steps in operation Compressor 1
S41	U	U			s*10	Safety times Compressor 1
S42	U	U				Circuit Compressor 2 0: Disabled 1: Circuit 1 2: Circuit 2
S43	U	U				Steps in operation Compressor 2
S44	U	U			s*10	Safety times Compressor 2
S45	U	U				Circuit Compressor 3 0: Disabled 1: Circuit 1 2: Circuit 2
S46	U	U				Steps in operation Compressor 3
S47	U	U			s*10	Safety times Compressor 3
S48	U	U				Circuit Compressor 4 0: Disabled 1: Circuit 1 2: Circuit 2
S49	U	U				Steps in operation Compressor 4
S50	U	U			s*10	Safety times Compressor 4
S51	U	U				Circuit Compressor 5 0: Disabled 1: Circuit 1 2: Circuit 2
S52	U	U				Steps in operation Compressor 5
S53	U	U			s*10	Safety times Compressor 5
S54	U	U				Circuit Compressor 6 0: Disabled 1: Circuit 1 2: Circuit 2
S55	U	U				Steps in operation Compressor 6
S56	U	U				Safety times Compressor 6
PSW						Password
S57	U	U				Current level 0: Hidden 1: User 2: Installer 3: Manufacturer
S58	U	U	-127	127		Password

14 ALARMS

All the alarms have automatic reset except for:

- **Antifreeze alarm:** manual reset
- **High pressure alarm:** manual reset if the number of occurrences per hour is higher than parameter A05
- **Phase sequence relay alarm:** manual reset
- **Compressor thermal switch alarm:** manual reset if the number of occurrences per hour is higher than parameter A25
- **Low pressure alarm:** manual reset if the number of occurrences per hour is higher than parameter A01
- **Flow alarm:** manual reset if the number of occurrences per hour is higher than parameter A08
- **Fan circuit alarm:** manual reset if the number of occurrences per is higher than parameter A20

Alarms which occur within 225 seconds (1/16 of an hour) from the first alarm are incorporated into the first one when counting the number of occurrences per hour.

Manual reset alarms are carried out by switching off the unit and then switching it back on.

The table below shows the meaning of the device's various alarm codes.

Code	Meaning
AFLo	<p>Flow alarm</p> <p>The alarm is activated when the input configured as the <i>Flow switch</i> is active for a time period equal to A10, with an A09 delay from pump activation. It is deactivated when the input is not active for a time period equal to A11</p> <p>The alarm is manually reset if the number occurrences per hour is higher than parameter A08.</p> <p>Main results:</p> <ul style="list-style-type: none"> - all the compressors, fans, system heating elements and the pump are immediately switched off. <p>The pump is reactivated after a period equal to A11.</p> <p>After pump activation the alarm is bypassed for a period equal to A09, during this delay the status of the Flow switch is not monitored.</p> <p>To ensure that following occurrences of the flow alarm are at least 225 seconds away each other in order not to be recorded as a single one it is strongly recommended, in case the default values are modified, to configure $A09+A10+A11 > 225$ seconds.</p>
AHtr	<p>High temperature alarm</p> <p>This alarm is activated when the input water temperature exceeds A16 for a time period longer than A17. It is deactivated when the temperature is lower than A16-A14.</p> <p>Main results:</p> <ul style="list-style-type: none"> - all the compressors are switched off
AbHp	<p>Heat pump block</p> <p>If one of the probes is configured as the external temperature, the function is enabled ($G24 = 1$), the boiler is not in alarm mode and the external temperature is lower than A28, the heat pump is blocked. It is reactivated when the external temperature becomes greater than $A28+A29$.</p> <p>Main results:</p> <ul style="list-style-type: none"> - all the compressors and fans are switched off
APH	<p>Phase sequence relay alarm</p> <p>The alarm is activated if the input configured as the phase sequence relay input is active. It is deactivated if the input is inactive.</p> <p>This alarm is reset manually.</p> <p>Main results:</p> <ul style="list-style-type: none"> - all loads are switched off
ArEb	<p>Boiler heating element thermal switch alarm</p> <p>The alarm is activated if the input configured as the boiler heating element thermal switch input is active. It is deactivated if the input is inactive.</p> <p>Main results:</p> <ul style="list-style-type: none"> - the boiler is switched off

Code	Meaning
APMP	<p>Pump thermal switch alarm</p> <p>The alarm is activated if the input configured as the pump thermal switch input is active. It is deactivated if the input is inactive.</p> <p>Main results:</p> <ul style="list-style-type: none"> - all the compressors, fans, system heating elements and the pump are switched off.
UArn	<p>Generic signal</p> <p>The alarm is activated if the input configured as the generic signal input is active. It is deactivated if the input is inactive.</p> <p>Main results:</p> <ul style="list-style-type: none"> - signal shown only on display
ALL	<p>Generic alarm</p> <p>The alarm is activated if the input configured as the general alarm input is active. It is deactivated if the input is inactive.</p> <p>Main results:</p> <ul style="list-style-type: none"> - all loads are switched off
ACnf	<p>Configuration alarm</p> <p>This alarm sounds if at least one of the following situations occurs:</p> <ul style="list-style-type: none"> • more than 6 power outputs (number of compressors and number of duty cycles) have been configured • a digital output has been configured as Thermostat step 1, but not On-Off compressors • the <i>Return probe</i> has been configured as a control probe but there is no relative analogue input configured • the <i>Supply probe</i> has been configured as a control probe but there is no relative analogue input configured • the <i>Condensing probe circuit 1</i> has been configured as a control probe but there is no relative analogue input configured • the <i>Evaporating probe circuit 1</i> has been configured as a control probe but there is no relative analogue input configured • the <i>Remote control</i> has been configured as a control probe but there is no relative analogue input configured or that input has been configured as NTC <p>Main results:</p> <ul style="list-style-type: none"> - all loads are switched off
EA	<p>Cumulative probe alarm</p> <p>This indicates that one of the probes is in alarm mode. Non-configured analogue inputs do not cause alarms.</p> <p>Main results:</p> <ul style="list-style-type: none"> - the functions in question are interrupted
AFr	<p>Antifreeze alarm</p> <p>The alarm is activated depending on the minimum temperature detected by the input water, output water and domestic hot water probes: the alarm comes on when the minimum value is below A13; it is deactivated when the value is above A13+A14.</p> <p>The alarm is delayed for a time period A12 from when it is switched on in heating mode.</p> <p>If the alarm occurs when the machine is in stand-by, the machine is switched on.</p> <p>This alarm is reset manually.</p> <p>Main results:</p> <ul style="list-style-type: none"> - all compressors and fans are switched off
ACoM	<p>Communication alarm</p> <p>The alarm is activated when there is no communication with the expansion for more than 10 seconds.</p> <ul style="list-style-type: none"> - the functions in question are interrupted. The probes read by the expansion enter probe error mode, the digital inputs read by the expansion go to 0, as does the reading of the frequency on the quick inputs; the analogue relay outputs activated by the expansion go to 0.
AHou	<p>Compressor/fan/pump operating hours exceeded alarm</p> <p>The alarm is activated when the operating hours of a compressor exceed A22 or the operating hours of a fan exceed A23 or the operating hours of the pump exceed A24.</p> <p>Main results:</p> <ul style="list-style-type: none"> - signal shown only on display

Code	Meaning
AHP1	Circuit 1/2 high pressure alarm
AHP2	The alarm is activated both by the high pressure switch and when the maximum value between that of the condensing probe and that of the evaporating probe exceeds the threshold set by A06. The alarm is manually reset if the number of events in an hour is higher than parameter A05. Main results: - the compressors of the circuit in question are switched off
ALP1	Circuit 1/2 low pressure alarm
ALP2	The alarm is activated both by the low pressure switch and when the minimum value between that of the condensing probe and that of the evaporating probe falls below the threshold set by A03. The alarm is deactivated when both conditions return to normal. The alarm is activated after a delay of A02 from compressor switch-on. The alarm is manually reset if the number of events in an hour is higher than parameter A01. Main results: - the compressors and fans of the circuit in question are switched off Note: in order to prevent the possibility that 2 following LP alarms are counted as a single occurrence (see explanation at the beginning of the chapter) the compressors minimum OFF time (C04) is by default fixed at 240 seconds
AF1	Circuit fan alarm
AF2	The alarm is activated if the input configured as the fan thermal switch is active. The alarm is deactivated if the input configured as the fan thermal switch is not active. The alarm is manually reset if the number of events in an hour is higher than parameter A20. Main results: - the compressors and fans of the circuit in question are switched off
At1	Circuit 1/1 compressor thermal switch alarm
At2	The alarm is activated if the input configured as the circuit 1/2 compressor thermal switch is active. It is deactivated if the input is inactive. The alarm is manually re-armed if the number of events in an hour is higher than parameter A25. Main results: - all the compressors of the circuit in question are switched off
Ad1	Circuit 1/2 compressor discharge high temperature alarm
Ad2	The alarm is activated if the reading of the probe configured as the circuit 1/2 compressor discharge rises above the A18 parameter value, and it is deactivated when this value falls below A18 - A19. Main results: - all the compressors of the circuit in question are switched off
AOi1	Circuit 1/2 oil return alarm
AOi2	The alarm is activated if the modulating compressor remains on at a percentage lower than A26 for a time greater than A27. The alarm only stops when the power requested by this circuit exceeds 90%. Main results: - all the compressors of the circuit in question are switched off.
AtC1	Compressor thermal switch alarm
AtC2	The alarm is activated if the input configured as compressor 1/2/3/4/5/6 thermal switch is active. It is deactivated if the input is inactive.
AtC3	The alarm is manually reset if the number of events in an hour is higher than parameter A25.
AtC4	Main results:
AtC5	- the compressor in question is switched off
AtC6	
AdS1	Compressor discharge high temperature alarm
AdS2	The alarm is activated if the reading of the probe configured as compressor 1/2/3/4/5/6 discharge rises above the A18 parameter value, and it is deactivated when this value falls below A18 - A19.
AdS3	Main results:
AdS4	- the compressor in question is switched off
AdS5	
AdS6	

Code	Meaning
EA01	Probe alarms
EA02	The alarm is activated in the following situations:
EA03	- when a probe short circuits or is interrupted
EA04	- if the upper or lower limit set for a probe are exceeded
EA05	Non-configured analogue inputs do not cause alarms
EA06	Main results:
EA07	- the functions in question are interrupted
EA08	
EA09	
EA10	
EA11	
EA12	
EA13	
EA14	

15 ACCESSORIES

15.1 INTRABUS/RS-485 interface and EVIF22ISX programming key



The interface converts the signal of the INTRABUS communications port of EV3 CHILL/HPRU and EVD CHILL/HPRU into an RS-485 signal with the same communication protocol. This enables cables up to 1000 m long to be used to connect the device to the user interface, as well as allowing the configuration upload and download of a device.

15.1.1 USING IT AS AN INTRABUS - RS485 INTERFACE

1. Place all the micro-switches of the two- and three-way DIP switch in the OFF position.

Note: In this condition the interface communicates with a fixed baud rate (the last valid one). Should it be necessary to modify the baud rate to ensure the communication rate please set the micro-switch number 3 of the three-way DIP switch in ON position. This way the interface will start a network scan to identify the correct baud rate (see interface instruction sheet for more information)

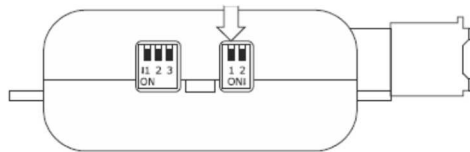

2. Connect the device to the controller's INTRABUS port as shown in the section ELECTRIC CONNECTION, namely:
 - connect terminal 1 to the "12 V" terminal
 - connect terminal 2 to the "INTRABUS data" terminal
 - connect terminal 3 to the "reference (GND)" terminal.
3. Connect the device to the RS485 port of the remote device that is to be controlled, namely:
 - connect terminal 4 to the "reference (GND)" terminal
 - connect terminal 5 to the "RS485 - (B) data" terminal
 - connect terminal 6 to the "RS485 + (A) data" terminal

For more information, consult the relevant instruction sheet.

It is possible to use the MODBUS protocol on the controller's INTRABUS network through a suitable chain of interfaces (EVIF22ISX + EVIF20TUXI for example).

If connected to an EV CHILL/HPRU device at power on and interrogated by a PC using the MODBUS protocol, the interface forces the device to use the MODBUS protocol on the INTRABUS network. The controllers in the EV CHILL/HPRU family use the MODBUS communication protocol on the INTRABUS network if they receive a valid MODBUS package on this port within the first couple of seconds after start-up. This circumstance only lasts during the flashing phase when the controller is starting up. The duration of the "listening" phase, when control functions have not yet been started up, is determined by the value of parameter G02 of EV CHILL/HPRU.

It is therefore possible to use configuration software such as Parameters Manager even when there is no RS485 port. It is not, however, advisable to use this interface when connecting to a BMS.



The characteristics of the MODBUS connection (the baud rate, parity and number of stop bits) are automatically detected by the interface if micro-switch 3 of the 3-way dip switch is in the OFF position (if this micro-switch is in the ON position, the parameters of the MODBUS network remain stable and the scan is inhibited). At power on, the interface will use the configuration it had before power off. If this is not consistent with the network used (for example in the past the interface was connected to a network with a baud rate of 9600 whereas in order to use the devices in the EV CHILL/HPRU family, the baud rate is 19200) at first the interface will not be able to communicate with the new baud rate (the red LED will begin flashing slowly, signalling this difference). In this case, just continue communicating with the interface at the desired baud rate for approximately 30 seconds (the red LED will continue flashing slowly). Once this safety time has elapsed, the red LED will start flashing quickly, indicating that the interface is scanning all the possible configurations of the MODBUS network parameters. When the red LED goes off, this means the interface is synchronised with the current network. Now we recommend powering off and then powering on again to store the new parameters and the interface will be ready to communicate in the new network.

15.1.2 Using it as a programming key

EVIF22ISX can also work as a programming key to upload and download EV3 CHILL/HPRU and EVD CHILL/HPRU configuration.

15.1.2.1 Configuration upload

- Place micro-switches 1, 2 and 3 of the 3-way dip switch in the ON position and micro-switches 1 and 2 of the 2-way dip switch in the ON position.

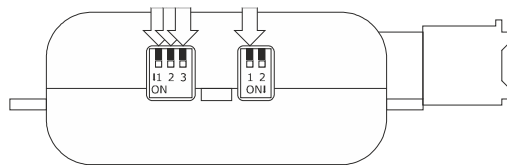

- Disconnect the controller; consult the relevant instruction sheet.
- Connect the device to the controller's INTRABUS port as shown in the section ELECTRIC CONNECTION, namely:
 - connect terminal 1 to the "12 V" terminal
 - connect terminal 2 to the "INTRABUS data" terminal
 - connect terminal 3 to the "reference (GND)" terminal.
- Power up the controller; consult the relevant instruction sheet.
 Device recognition will start up.
 Recognition normally takes a couple of seconds; when this is over, the green LED and the red LED stay on.
 The configuration upload is then started up.
 The upload normally takes a couple of seconds. If the upload is successful, the green LED stays on and the red LED goes off; if the upload fails, the green LED goes off and the red LED stays on (repeat the upload).

15.1.2.2 Configuration download

	<p>N.B.</p> <ul style="list-style-type: none"> - the configuration download is possible if the firmware of the controller it originates from and the firmware of the destination controller are the same - if the configuration download fails, it may be necessary to refresh the controller's factory (default) settings; consult the relevant instruction sheet.
---	---

1. Place micro-switches 1, 2 and 3 of the 3-way dip switch in the OFF position and micro-switches 1 and 2 of the 2-way dip switch in the ON position.

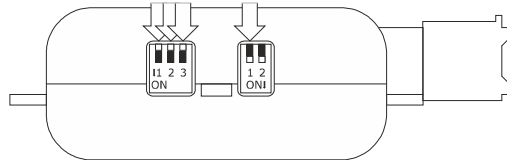

2. Disconnect the controller; consult the relevant instruction sheet.
3. Connect the device to the controller's INTRABUS port as shown in the section ELECTRIC CONNECTION, namely:
 - connect terminal 1 to the "12 V" terminal
 - connect terminal 2 to the "INTRABUS data" terminal
 - connect terminal 3 to the "reference (GND)" terminal.

4. Power up the controller; consult the relevant instruction sheet.

Device recognition will start up.

Recognition normally takes a couple of seconds; when this is over, the green LED and the red LED stay on.

The configuration download is then started up.

The download normally takes a couple of seconds. If the download is successful, the green LED stays on and the red LED goes off; if download fails, the green LED goes off and the red LED stays on (repeat the download).

15.2 RS-485/USB EVIF20SUXI serial interface

With this interface, it is possible to connect EV3 CHILL/HPRU and EVD CHILL/HPRU to the Parameters Manager set-up software or a supervision system.



15.3 0025100010 drip protector

This drip protector shields EV3 CHILL/HPRU and EV3K01 from damp.



15.4 CJAV connection kit (connectors to wire up the devices)

It is possible to wire up EV3 CHILL/HPRU, EVD CHILL/HPRU and EVD094 using the kits.

Device purchasing code	Connectors purchasing code
EV3904LM2 ed EV3904LM2GF	CJAV37
EV3906LM2GF	CJAV39
EVD904BM9	CJAV38
EVD904BM9MF	CJAV38
EVD904LM9MF	CJAV38
EV3914LM2 ed EV3914LM2GF	CJAV37
EV3916LM2GF	CJAV39
EVD914BM9	CJAV38
EVD914BM9MF	CJAV38
EVD914LM9MF	CJAV38
EVD094EM9	CJAV38



16 TECHNICAL SPECIFICATIONS

16.1 Technical specifications EV3 CHILL/HPRU

Purpose of the control device	function controller	
Construction of the control device	built-in electronic device	
Housing	black, self-extinguishing	
Category of heat and fire resistance	D	
Measurements	75.0 x 33.0 x 59.0 mm (2 15/16 x 1 5/16 x 2 5/16 in)	
Mounting methods for the control device	to be fitted to a panel, snap-in brackets provided	
Degree of protection provided by the casing	IP65 (front)	
Connection method		
Micro-Fit connectors	Edge connectors	plug-in screw terminal blocks
Maximum permitted length for connection cables		
power supply: 10 m (32.8 ft)	analogue inputs: 10 m (32.8 ft)	
auxiliary power supply: 10 m (32.8 ft)	digital inputs: 10 m (32.8 ft)	
0-10 V and phase cut analogue outputs: 10 m (32.8 ft)	PWM analogue outputs: 1 m (3.28 ft)	
digital outputs: 10 m (32.8 ft)	INTRABUS port: 10 m (32.8 ft)	
RS-485 MODBUS port: 1,000 m (3,280 ft)		
Operating temperature	from -10 to 55 °C (from 14 to 131 °F)	
Storage temperature	from -20 to 70 °C (from -4 to 158 °F)	
Operating humidity	relative humidity without condensate from 5 to 95 %	
Pollution status of the control device	2	
Compliance		
RoHS 2011/65/EC	WEEE 2012/19/EU	
REACH (EC) Regulation no. 1907/2006	EMC 2014/30/EU	
Power supply	12 VAC (+10% -15%), 50/60 Hz (±3 Hz), max. 7 VA not insulated	
Protect the power supply with a 1 A-T 250 VAC fuse		
Earthing methods for the control device	none	
Rated impulse-withstand voltage	4 KV	
Over-voltage category	III	
Software class and structure	A	
Clock	According to the model (with secondary lithium battery)	
Clock drift	≤ 60 s/month at 25 °C (77 °F)	
Clock battery autonomy in the absence of a power supply	> 6 months at 25 °C (77 °F)	
Clock battery charging time	24 h (the battery is charged by the power supply of the device)	
Analogue inputs	5 for NTC probes (can also be configured for dry contact digital input) 2 for NTC probes, 4-20 mA, 0-5 V or 0-10 V transducers (can also be configured for dry contact digital input)	

NTC probes	Sensor type	β3435 (10 KOhm @ 25 °C, 77 °F)	
	Measurement field	from -50 to 120 °C (from -58 to 248 °F)	
	Resolution	0.1 °C (1 °F)	
0-10 V transducers	Input heating element	> 10 KOhm	
	Resolution	0.1 V	
4-20 mA transducers	Input heating element:	≤ 200 Ohm	
	Resolution:	0.01 mA	
Auxiliary power supply		12 VDC, max. 100 mA	
Digital inputs		3 dry contacts	
Dry contact:	Contact type	3.3 VDC, 1 mA	
	Power supply	none	
Analogue outputs		2 for 0-10 V, PWM or phase cut signal	
0-10 V signal	Minimum applicable impedance	1 KOhm	
	Resolution	0.01 V	
PWM signal	Power supply	0... 10 VDC (+16% -25), 10 mA max	
	Frequency	10 Hz... 2 KHz	
	Duty:	0... 100%	
Digital outputs		4 SPST electro-mechanical relays, 2 A res. @ 250 VAC	
		depending on the model, 1 200 mA triac res. @ 250 VAC at 25 °C (77 °F)	
		depending on the model, 1 2 A triac res. @ 250 VAC at 25 °C (77 °F)	
Type 1 or Type 2 actions		Type 1	
Additional features of Type 1 or Type 2 actions		C	
Displays		two-line LED display	
Alarm buzzer		built-in	
Communications ports			
1 INTRABUS port		According to the model, 1 RS-485 MODBUS port	

16.2 EVD CHILL/HPRU technical specifications

Purpose of the control device	16.3 function controller
Construction of the control device	built-in electronic device
Housing	grey, self-extinguishing
Category of heat and fire resistance	D
Measurements	71.0 x 168.0 x 60.0 mm (2 13/16 x 6 5/8 x 2 3/8 in) 4 DIN modules
Mounting methods for the control device	installation on a DIN rail in a control panel; the dimensions of the DIN rail must be 35.0 x 7.5 mm (1 3/8 x 5/16) or 35.0 x 15.0 mm (1 3/8 x 9/16).
Degree of protection provided by the casing	IP40 (front)
Connection method	
Micro-Fit connectors	plug-in screw terminal blocks
Maximum permitted length for connection cables	
power supply: 10 m (32.8 ft)	analogue inputs: 10 m (32.8 ft)
auxiliary power supply: 10 m (32.8 ft)	digital inputs: 10 m (32.8 ft)
0-10 V and phase cut analogue outputs: 10 m (32.8 ft)	PWM analogue outputs: 1 m (3.28 ft)
digital outputs: 10 m (32.8 ft)	INTRABUS port: 10 m (32.8 ft)
RS-485 MODBUS port: 1,000 m (3,280 ft)	
Operating temperature	from -10 to 55 °C (from 14 to 131 °F)
Storage temperature	from -20 to 70 °C (from -4 to 158 °F)
Operating humidity	relative humidity without condensate from 5 to 95%
Pollution status of the control device	2
Compliance	
RoHS 2011/65/EC	WEEE 2012/19/EU
REACH (EC) Regulation no. 1907/2006	EMC 2014/30/EU
Power supply	115... 230 VAC (+10 % -15 %), 50/60 Hz (±3 Hz), max. 6 VA insulated
Protect the power supply with a 2 A-T 250 VAC fuse	
Earthing methods for the control device	none
Rated impulse-withstand voltage	4 KV
Over-voltage category	II
Software class and structure	A
Clock	According to the model (with secondary lithium battery)
Clock drift	≤ 60 s/month at 25 °C (77 °F)
Clock battery autonomy in the absence of a power supply	> 6 months at 25 °C (77 °F)
Clock battery charging time	24 h (the battery is charged by the power supply of the device)

Analogue inputs		5 for NTC probes (can also be configured for dry contact digital input) 2 for NTC probes, 4-20 mA, 0-5 V or 0-10 V transducers (can also be configured for dry contact digital input)
NTC probes	Sensor type	B3435 (10 KOhm @ 25 °C, 77 °F)
	Measurement field	from -50 to 120 °C (from -58 to 248 °F)
	Resolution	0.1 °C (1 °F)
0-10 V transducers	Input heating element	> 10 KOhm
	Resolution	0.1 V
4-20 mA transducers	Input heating element	≤ 200 Ohm
	Resolution	0.01 mA
Auxiliary power supply		12 VDC, max. 40 mA
Digital inputs		3 dry contacts
Dry contact	Contact type	3.3 VDC, 1 mA
	Power supply	none
Analogue outputs		2 for 0-10 V, PWM or phase cut signal
0-10 V signal	Minimum applicable impedance	1 KOhm
	Resolution	0.01 V
PWM signal	Power supply	0... 10 VDC (+16% -25%), 10 mA max.
	Frequency	10 Hz... 2 KHz
	Duty	0... 100%
Digital outputs:		4 electro-mechanical relays: - 2 SPST, 3 A res. @ 250 VAC - 1 SPDT, 8 A res. @ 250 VAC - 1 SPST, 12 A res. @ 250 VAC 1 open collector (12 V, max. 40 mA)
Type 1 or Type 2 actions		Type 1
Additional features of Type 1 or Type 2 actions		C
Displays		two-line LED display (depending on the model), signalling LED
Alarm buzzer		according to the model
Communications ports		
1 INTRABUS port		1 RS-485 MODBUS port

EV3 CHILL/HPRU & EVD CHILL/HPRU

Controllers for single and dual-circuit chillers and heat pumps

Application manual ver. 3.0b

PT - 25/20

Code 1443DCHI304

This document and the solutions contained therein are the intellectual property of EVCO and thus protected by the Italian Intellectual Property Rights Code (CPI). EVCO imposes an absolute ban on the full or partial reproduction and disclosure of the content other than with the express approval of EVCO. The customer (manufacturer, installer or end user) assumes all responsibility for the configuration of the device. EVCO accepts no liability for any possible errors in this document and reserves the right to make any changes at any time without prejudice to the essential functional and safety features of the equipment.



EVCO S.p.A.

Via Feltre 81, 32036 Sedico Belluno ITALY
Tel. +39 0437/8422 | Fax +39 0437/83648
info@evco.it | www.evco.it