

c-pro 3 giga

Programmable controllers
(up to 43 I/O)



Hardware manual | ENGLISH

Code 144CP3GI204



BACnet® is a registered trademark of ASHRAE

WebServer



PLEASE READ CAREFULLY
and save this document
CONSIDER THE ENVIRONMENT

approved controller
for
ebmpapst products

APPROVED CONTROLLER FOR ZIEHL-ABEGG



Read this document carefully before installation and before using the device and take all the prescribed precautions. Keep this document with the device for future reference. Only use the device in the ways described in this document.



The device must be disposed of according to local regulations governing the collection of electrical and electronic equipment.

Index

1	INTRODUCTION	4
2	MAIN FEATURES OF THE MODELS AVAILABLE AND PURCHASING CODES	5
3	MEASUREMENTS AND INSTALLATION	7
3.1	Measurements of open frame models	7
3.2	Measurements of models with housing.....	7
3.3	Installation.....	8
4	DESCRIPTION	9
5	ELECTRICAL CONNECTION	10
5.1	Connectors available in all the controllers.....	10
5.2	Connectors only available in the plus controllers	12
5.3	Fitting the termination resistor of the RS-485 networks and the CAN network.....	13
5.4	Example of electrical connection	14
6	CONFIGURATION.....	15
6.1	Initial information	15
6.2	Example of configuration using the remote EPJgraph user interface.....	15
7	SIGNALLING LEDS.....	18
8	CONFIGURATION PARAMETERS.....	19
8.1	Configuration parameters of the "Info" menu.....	19
8.2	Configuration parameters of the "Parameters" menu	19
8.3	Configuration parameters of the "CAN Bus" sub-menu of the "Networks" menu	23
8.4	Configuration parameters of the "UART1" sub-menu of the "Networks" menu	23
8.5	Configuration parameters of the "UART2" sub-menu of the "Networks" menu	24
8.6	Configuration parameters of the "Ethernet" sub-menu of the "Networks" menu	24
8.7	Configuration parameters of the "USB" sub-menu of the "Networks" menu.....	25
8.8	Configuration parameters of the "Password" menu	25
8.9	Configuration parameters of the "Diagnostics" menu	26
8.10	Configuration parameters of the "Debug" menu	27
9	ACCESSORIES	28
9.1	Connecting cable for Personal Computer	28
9.2	Connecting cable for USB flash drive	28
9.3	RS-485/USB serial interface	28
9.4	INTRABUS/RS-485 serial interface.....	28
9.5	EVlink TTL/BLE module	28
9.6	EVlink TTL/Wi-Fi module	28
9.7	USB flash drive	29
9.8	Connection kit	29
9.9	Connection kit	29
10	TECHNICAL SPECIFICATIONS	30

1 INTRODUCTION

The range of c-pro 3-giga programmable controllers has up to 43 I/O, as well as a wide range of communications ports and protocols, making possible advanced management of HVAC/R applications, also according to their use in local or remote control systems.

The application software can be set up quickly and intuitively thanks to the UNI-PRO 3 integrated development environment. The NODE versions have an Ethernet port for the use of MODBUS TCP, BACnet IP and Web Server; all the versions have a data-logging function.

In the 10 DIN module blind version, the controller is compatible with all the displays of the programmable c-pro 3 range, available in a wide choice of formats, technologies and installation methods.

2 MAIN FEATURES OF THE MODELS AVAILABLE AND PURCHASING CODES

PURCHASING CODES	EPG90	EPG9B	EPG9OHX	EPG9BHX	EPG9BXQ	EPG9BHQ	EPG9BXP	EPG9BHP
Version	BASIC	BASIC	NODE	NODE	BASIC PLUS	BASIC PLUS	NODE PLUS	NODE PLUS
FORMAT								
10 DIN modules, open frame	•	•						
10 DIN modules with housing			•	•	•	•	•	•
USER INTERFACE								
Blind version	•	•	•	•	•	•	•	•
INSTALLATION								
On a DIN rail	•	•	•	•	•	•	•	•
CONNECTIONS								
Fixed screw terminal blocks	•	•						
Plug-in screw terminal blocks			•	•	•	•	•	•
POWER SUPPLY								
115... 230 VAC	•	•	•	•	•	•	•	•
ANALOGUE-DIGITAL INPUTS								
PTC/NTC/Pt 1000 or dry contact digital input	5	5	5	5	8	8	8	8
PTC/NTC/Pt 1000/0-5 V/0-10 V/0-20 mA/4-20 mA or dry contact digital input	5	5	5	5	8	8	8	8
DIGITAL INPUTS								
Dry contact and for pulse trains up to 2 KHz	3	3	3	3	7	7	3	3
High voltage	2	2	2	2	2	2	2	2
ANALOGUE OUTPUTS								
0-10 V/PWM	4	4	4	4	4	4	8	8
DIGITAL OUTPUTS (ELECTRO-MECHANICAL RELAYS)								
2 A SPST	2	2	2	2	6	6	6	6
3 A SPST	5	5	5	5	5	5	5	5
3 A SPDT	1	1	1	1	1	1	1	1
8 A SPST	1	1	1	1	2	2	2	2
COMMUNICATIONS PORTS								
TTL MODBUS	1	1	1	1	1	1	1	1
INTRABUS (RS-485 MODBUS master/slave using the EVIF22ISX serial interface)	1	1	1	1	1	1	1	1
RS-485 MODBUS slave	1	1	1	1	1	1	1	1
RS-485 (MODBUS master/slave, BACnet MS/TP) ⁽¹⁾	1	1	1	1	1	1	1	1
CAN	1	1	1	1	1	1	1	1
USB	1	1	1	1	1	1	1	1
Ethernet (MODBUS TCP, WebServer, BACnet IP) ⁽¹⁾			1	1			1	1
OTHER STANDARD FEATURES								
RTC	•	•	•	•	•	•	•	•

OPTIONAL FEATURES (USING ADDITIONAL ACCESSORIES)

BLE connectivity (using the EVIF25TBX module)	•	•	•	•	•	•	•	•
Wi-Fi connectivity (using the EVIF25TWX or EVIF25SWX module)	•	•	•	•	•	•	•	•

NOTES

⁽¹⁾ the BACnet communication protocol is an alternative to the Web Server function.

3 MEASUREMENTS AND INSTALLATION

3.1 Measurements of open frame models

Measurements are expressed in mm (inches).

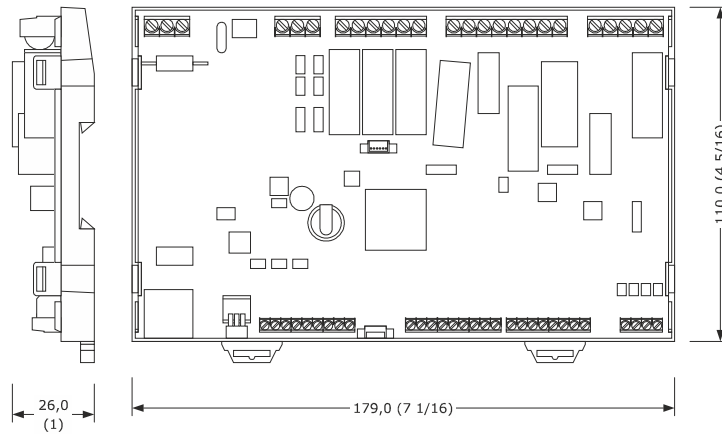

3.2 Measurements of models with housing

Measurements are expressed in mm (inches).

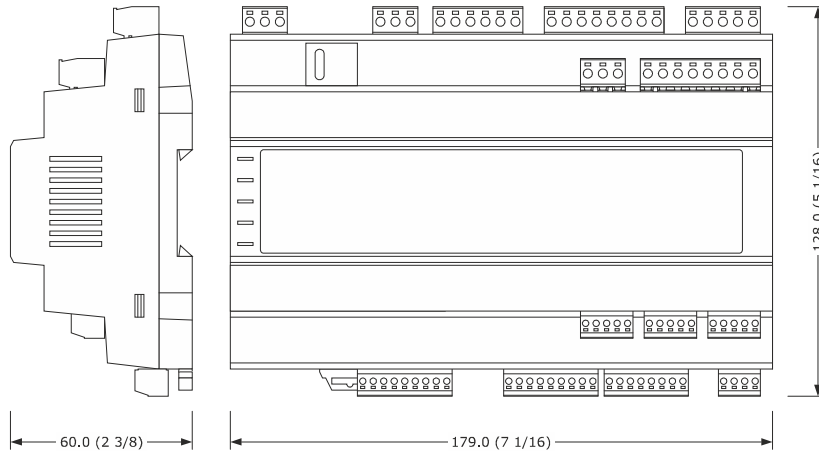

3.3 Installation

On a DIN rail in a control panel.

To install the device, proceed as shown in figures 1 and 2.



To uninstall the device, first remove any plug-in screw terminal blocks at the bottom then proceed as shown in figures 3 and 4.

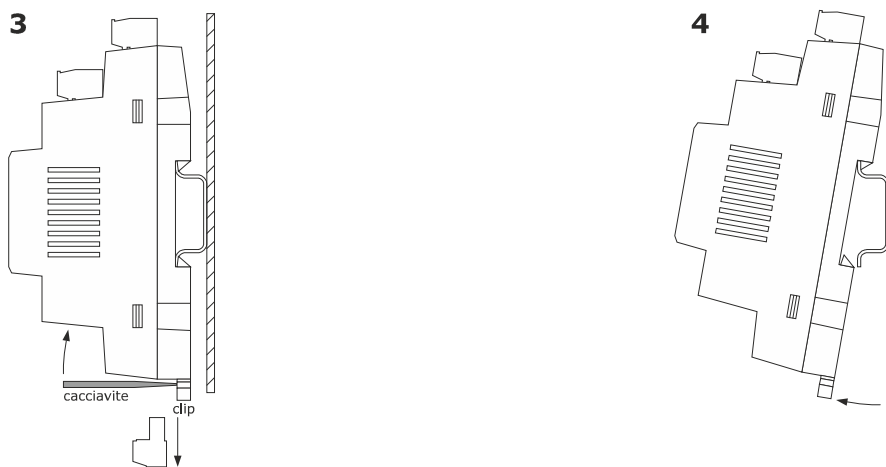

To re-install the device, first press the clip fully in.

INSTALLATION PRECAUTIONS

- ensure that the working conditions are within the limits stated in the *TECHNICAL SPECIFICATIONS* section
- do not install the device close to heat sources, equipment with a strong magnetic field, in places subject to direct sunlight, rain, damp, excessive dust, mechanical vibrations or shocks
- in compliance with safety regulations, the device must be installed properly to ensure adequate protection from contact with electrical parts. All protective parts must be fixed in such a way as to need the aid of a tool to remove them

4 DESCRIPTION

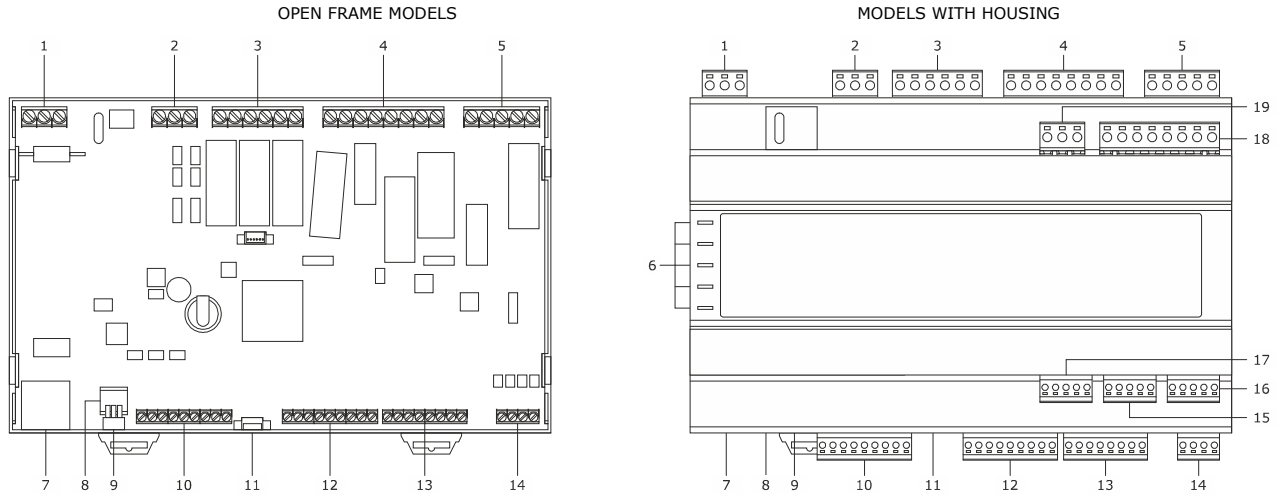

PART	DESCRIPTION
1	Power supply
2	High voltage digital inputs
3	Digital outputs (electro-mechanical relays) 1... 3
4	Digital outputs (electro-mechanical relays) 4... 7
5	Digital outputs (electro-mechanical relays) 8... 9
6	Signalling LED
7	Ethernet port (MODBUS TCP, WebServer, BACnet IP)
8	Micro-switch for: <ul style="list-style-type: none"> - fitting the termination resistor of the RS-485 network connected to the RS-485 MODBUS slave port - fitting the termination resistor of the RS-485 network connected to the RS-485 (MODBUS master/slave, BACnet MS/TP) port - fitting the termination resistor of the CAN network
9	USB port
10	CAN port, RS-485 (MODBUS master/slave, BACnet MS/TP) port, RS-485 MODBUS slave port and INTRABUS port
11	TTL MODBUS port
12	Analogue-digital inputs 1... 5 and dry contact digital inputs and for pulse trains up to 2 KHz
13	Analogue-digital inputs 6... 10
14	Analogue outputs 1... 4
15	Only available in the plus controllers - Analogue-digital inputs 15... 16
16	Only available in the plus controllers - Analogue outputs 5... 8 (for models EPG9BXP and EPG9BHP), digital inputs 6... 9 (for models EPG9BXQ and EPG9BHQ)
17	Only available in the plus controllers - Analogue-digital inputs 11... 14
18	Only available in the plus controllers - Digital outputs (electro-mechanical relays) 11... 14
19	Only available in the plus controllers - Digital output (electro-mechanical relay) 10

5 ELECTRICAL CONNECTION

	<p>N.B.</p> <ul style="list-style-type: none"> - use cables of an adequate section for the current running through them - to reduce any electromagnetic interference, connect the power cables as far away as possible from the signal cables and, if necessary, connect to a RS-485 MODBUS network and/or a CAN network by using a twisted pair - the maximum number of devices that can be connected in a CAN network is 32 and depends on the BUS load: the BUS load depends, in turn, on the baud rate of the CAN communication and on the type of device (for example, a CAN network can be made up of a programmable controller, 4 I/O expansions and 4 remote user interfaces with a baud rate of 500,000 baud)
---	---

5.1 Connectors available in all the controllers

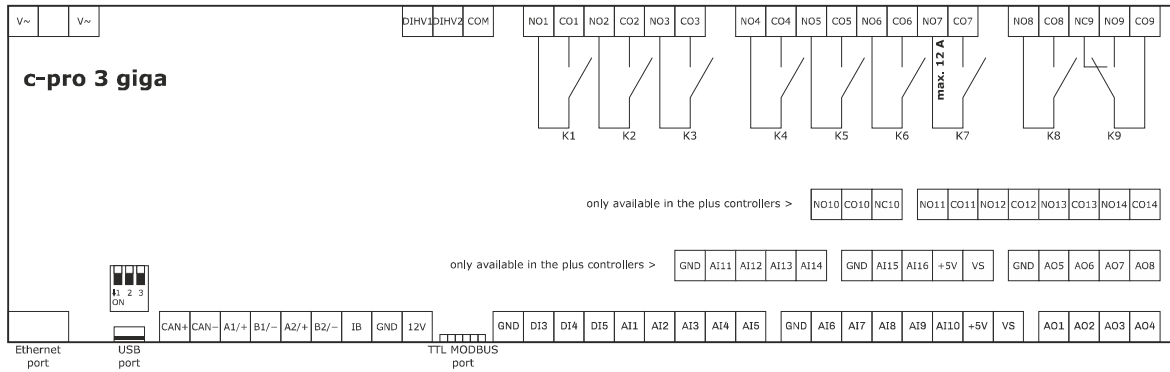

CONN.	DESCRIPTION
V~	device power supply (115... 230 VAC)
V~	device power supply (115... 230 VAC)

CONN.	DESCRIPTION
DIHV1	high voltage digital input; DI1
DIHV2	high voltage digital input; DI2
COM	common contact high voltage digital inputs

CONN.	DESCRIPTION
NO1	K1 digital output normally open contact (3 A res. @ 250 VAC)
CO1	K1 digital output common contact
NO2	K2 digital output normally open contact (3 A res. @ 250 VAC)
CO2	K2 digital output common contact
NO3	K3 digital output normally open contact (3 A res. @ 250 VAC)
CO3	K3 digital output common contact
NO4	K4 digital output normally open contact (3 A res. @ 250 VAC)
CO4	K4 digital output common contact
NO5	K5 digital output normally open contact (2 A res. @ 250 VAC)
CO5	K5 digital output common contact
NO6	K6 digital output normally open contact (3 A res. @ 250 VAC)
CO6	K6 digital output common contact
NO7	K7 digital output normally open contact (8 A res. @ 250 VAC)
CO7	K7 digital output common contact

CONN.	DESCRIPTION
NO8	K8 digital output normally open contact (2 A res. @ 250 VAC)
CO8	K8 digital output common contact
NC9	K9 digital output normally closed contact
NO9	K9 digital output normally open contact (3 A res. @ 250 VAC)
CO9	K9 digital output common contact

CONN.	DESCRIPTION
CAN+	signal + CAN port
CAN-	signal - CAN port
A1/+	signal+ RS-485 MODBUS slave port
B1/-	signal - RS-485 MODBUS slave port
A2/+	signal + RS-485 (MODBUS master/slave, BACnet MS/TP) port
B2/-	signal - RS-485 (MODBUS master/slave, BACnet MS/TP) port
IB	INTRABUS port
GND	reference (GND)
12V	power supply remote user interfaces (13 VDC)

The BACnet communication protocol is an alternative to the Web Server function.

The current UNI-PRO 3.16 version uses a standard BACnet® B-ASC device profile. Management of the Scheduler and Calendar objects is not included in this profile, while it is in the B-AAC profile.

CONN.	DESCRIPTION
GND	reference (GND)
DI3	digital input 3 (dry contact and for pulse trains up to 2 KHz); DI3
DI4	digital input 4 (dry contact and for pulse trains up to 2 KHz); DI4
DI5	digital input 5 (dry contact and for pulse trains up to 2 KHz); DI5
AI1	analogue input 1 (for PTC, NTC or Pt 1000 probes) AI1 can also be configured for dry contact digital input
AI2	analogue input 2 (for PTC, NTC or Pt 1000 probes) AI2 can also be configured for dry contact digital input
AI3	analogue input 3 (for PTC, NTC or Pt 1000 probes) AI3 can also be configured for dry contact digital input
AI4	analogue input 4 (for PTC, NTC or Pt 1000 probes) AI4 can also be configured for dry contact digital input
AI5	analogue input 5 (for PTC, NTC or Pt 1000 probes) AI5 can also be configured for dry contact digital input

CONN.	DESCRIPTION
GND	reference (GND)
AI6	analogue input 6 (for PTC, NTC or Pt 1000 probes, 0-5 V, 0-10 V, 0-20 mA or 4-20 mA transducers); AI6 can also be configured for dry contact digital input
AI7	analogue input 7 (for PTC, NTC or Pt 1000 probes, 0-5 V, 0-10 V, 0-20 mA or 4-20 mA transducers); AI7 can also be configured for dry contact digital input
AI8	analogue input 8 (for PTC, NTC or Pt 1000 probes, 0-5 V, 0-10 V, 0-20 mA or 4-20 mA transducers); AI8 can also be configured for dry contact digital input
AI9	analogue input 9 (for PTC, NTC or Pt 1000 probes, 0-5 V, 0-10 V, 0-20 mA or 4-20 mA transducers); AI9 can also be configured for dry contact digital input
AI10	analogue input 10 (for PTC, NTC or Pt 1000 probes, 0-5 V, 0-10 V, 0-20 mA or 4-20 mA transducers); AI10 can also be configured for dry contact digital input
+5V	0-5 V ratiometric transducers power supply (5 VDC)
VS	transducers power supply (13 VDC)

CONN.	DESCRIPTION
AO1	analogue output 1 (for 0-10 V or PWM signal)
AO2	analogue output 2 (for 0-10 V or PWM signal)
AO3	analogue output 3 (for 0-10 V or PWM signal)
AO4	analogue output 4 (for 0-10 V or PWM signal)

5.2 Connectors only available in the plus controllers

CONN.	DESCRIPTION
NO10	K10 digital output normally open contact (8 A res. @ 250 VAC)
CO10	K10 digital output common contact
NC10	K10 digital output normally closed contact
NO11	K11 digital output normally open contact (5 A res. @ 250 VAC)
CO11	K11 digital output common contact
NO12	K12 digital output normally open contact (5 A res. @ 250 VAC)
CO12	K12 digital output common contact
NO13	K13 digital output normally open contact (5 A res. @ 250 VAC)
CO13	K13 digital output common contact
NO14	K14 digital output normally open contact (5 A res. @ 250 VAC)
CO14	K14 digital output common contact

CONN.	DESCRIPTION
GND	reference (GND)
AI11	analogue input 11 (for PTC, NTC or Pt 1000 probes); AI11 can also be configured for dry contact digital input
AI12	analogue input 12 (for PTC, NTC or Pt 1000 probes); AI12 can also be configured for dry contact digital input
AI13	analogue input 13 (for PTC, NTC or Pt 1000 probes); AI13 can also be configured for dry contact digital input
AI14	analogue input 14 (for PTC, NTC or Pt 1000 probes, 0-5 V, 0-10 V, 0-20 mA or 4-20 mA transducers); AI14 can also be configured for dry contact digital input

CONN.	DESCRIPTION
GND	reference (GND)
AI15	analogue input 15 (for PTC, NTC or Pt 1000 probes, 0-5 V, 0-10 V, 0-20 mA or 4-20 mA transducers); AI15 can also be configured for dry contact digital input
AI16	analogue input 16 (for PTC, NTC or Pt 1000 probes, 0-5 V, 0-10 V, 0-20 mA or 4-20 mA transducers); AI16 can also be configured for dry contact digital input
+5V	0-5 V ratiometric transducers power supply (5 VDC)
VS	transducers power supply (13 VDC)

CONN.	DESCRIPTION (for models EPG9BXP and EPG9BHP)
A05	analogue output 5 (for 0-10 V or PWM signal)
A06	analogue output 6 (for 0-10 V or PWM signal)
A07	analogue output 7 (for 0-10 V or PWM signal)
A08	analogue output 8 (for 0-10 V or PWM signal)

CONN.	DESCRIPTION
GND	reference (GND)
DI6	digital input 6 (dry contact); DI6
DI7	digital input 7 (dry contact); DI7
DI8	digital input 8 (dry contact); DI8
DI9	digital input 9 (dry contact); DI9

5.3 Fitting the termination resistor of the RS-485 networks and the CAN network

To fit the termination resistor of the RS-485 network connected to the RS-485 MODBUS slave port, place the **MBS1LT** micro-switch in position ON.

To fit the termination resistor of the RS-485 network connected to the RS-485 (MODBUS master/slave, BACnet MS/TP) port, place the **MBS2LT** micro-switch in position ON.

To fit the termination resistor of the CAN network, place the **CANLT** micro-switch in position ON.

5.4 Example of electrical connection

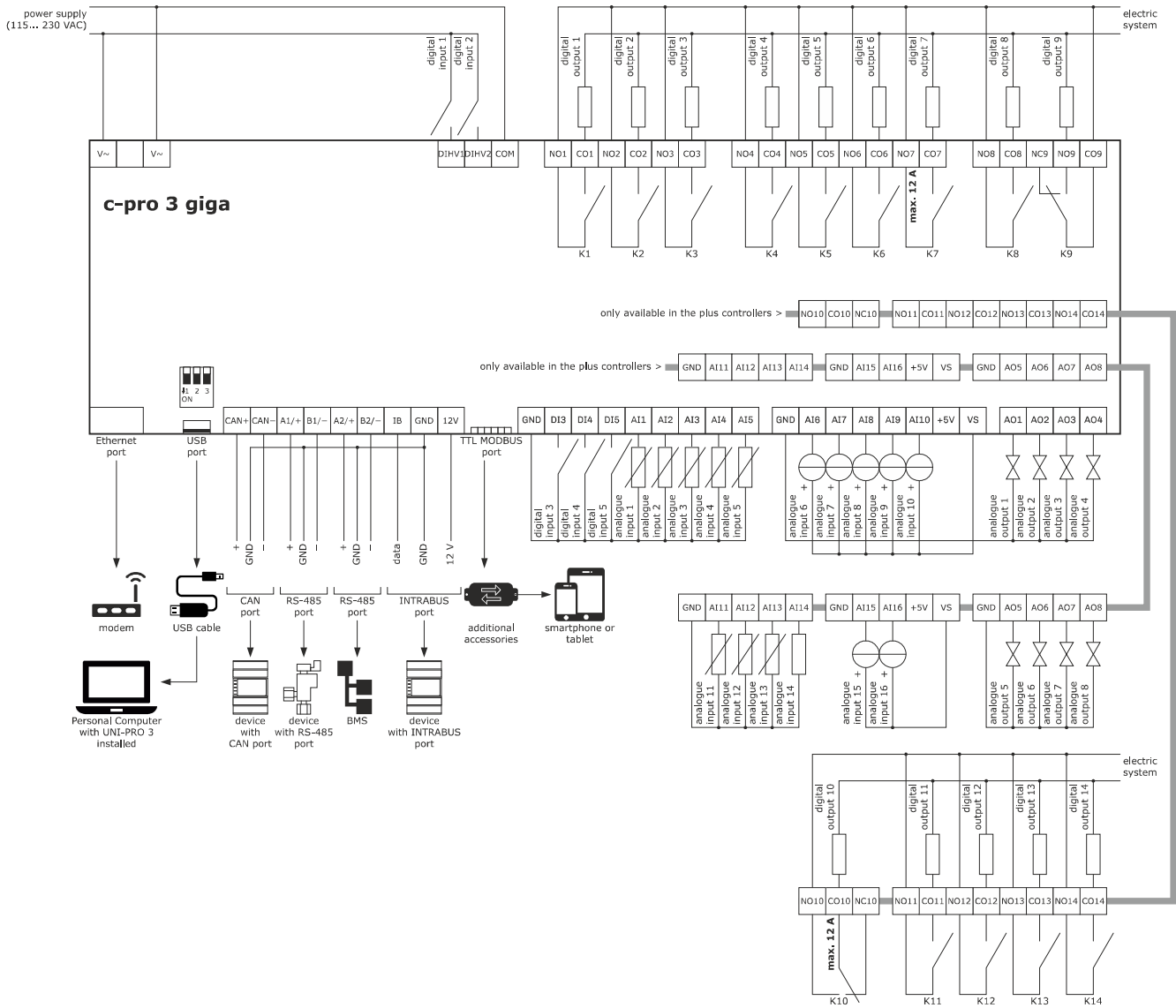

PRECAUTIONS FOR ELECTRICAL CONNECTION

- if using an electrical or pneumatic screwdriver, adjust the tightening torque
- if the device is moved from a cold to a warm place, humidity may cause condensation to form inside. Wait for about an hour before switching on the power
- make sure that the supply voltage, electrical frequency and power are within the set limits. See the section *TECHNICAL SPECIFICATIONS*
- disconnect the power supply before carrying out any type of maintenance
- do not use the device as a safety device
- for repairs and further information, contact the EVCO sales network

6 CONFIGURATION

6.1 Initial information

To configure the device, users will need a programmable controller with a built-in or remote user interface.

6.2 Example of configuration using the remote EPJgraph user interface

1. Make sure neither the device nor the remote user interface is powered up.
2. Connect the device and the remote user interface as shown in the diagram below without powering up the device.

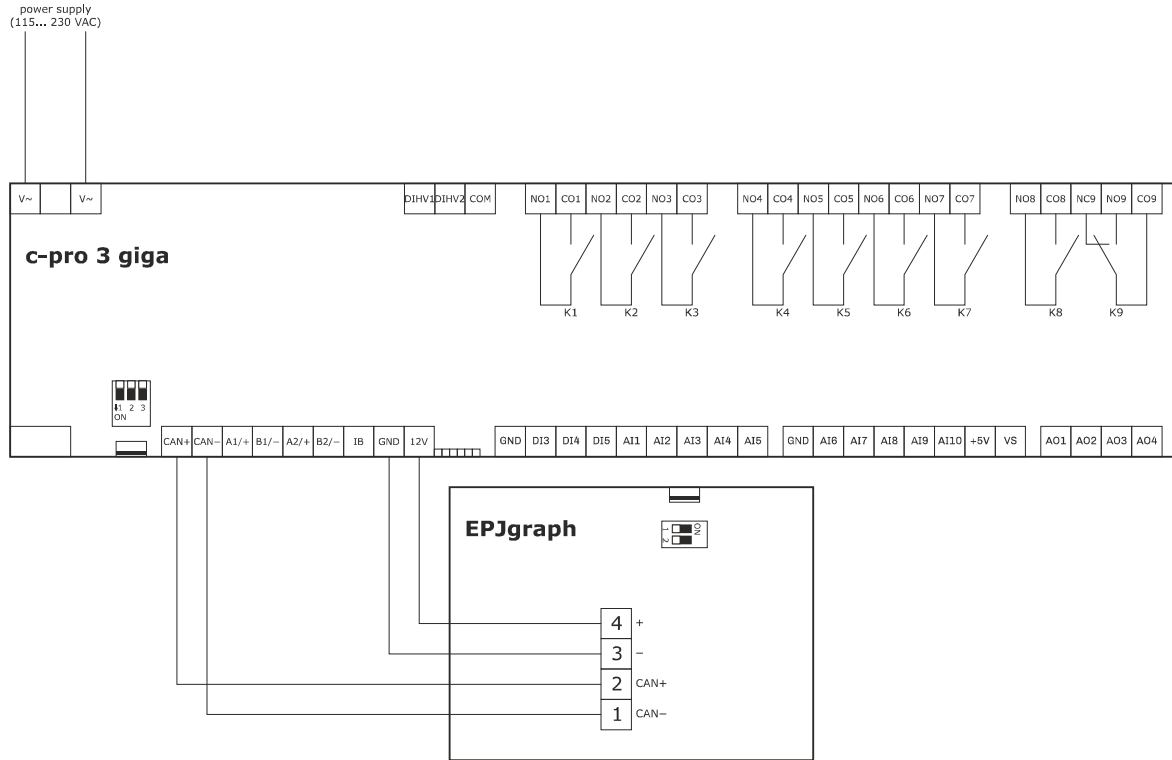

3. Power up the device.
4. Use the remote user interface as shown in the following procedures.

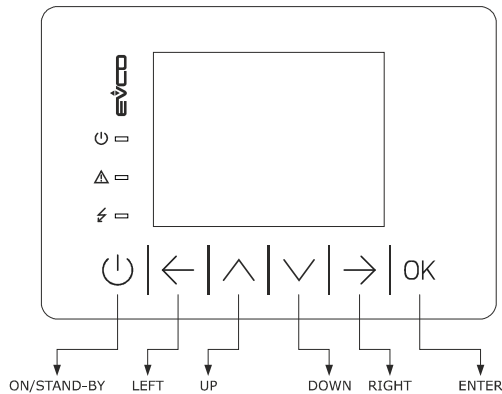

- | | | |
|-----|--|---|
| 5. | | Touch the LEFT and ENTER keys for 2 s; the display will show the "Network Status (CAN)" screen. |
| 6. | | Touch the ENTER key: the display will show the main menu. |
| 7. | | Touch the UP or DOWN key to select the "Networks" menu. |
| 8. | | Touch the ENTER key. |
| 9. | | Touch the UP or DOWN key to select the "CAN BUS" sub-menu. |
| 10. | | Touch the ENTER key to access the menu: the display will show the "Input Password" screen. |
| 11. | | Touch the ENTER key again. |
| 12. | | Touch the UP or DOWN key to set "-19". |
| 13. | | Touch the ENTER key: the display will show the "CAN Network" screen. |
| 14. | | Touch the UP or DOWN key to select "Network Node". |
| 15. | | Touch the ENTER key. |
| 16. | | Touch the UP or DOWN key to set the device node (for example "[1]"). |
| 17. | | Touch the ENTER key. |
| 18. | | Touch the DOWN key. |
| 19. | | Touch the ENTER key. |
| 20. | | Touch the UP or DOWN key to set the address of the device node (default "1"). |
| 21. | | Touch the ON/STAND-BY key a few times to return to the previous displays. |
| 22. | | Disconnect the device from the mains. |
| 23. | | Power up the device. |

- 24.  Touch the LEFT and ENTER keys for 2 s: the display will show the "Network Status (CAN)" screen.

Network Status (CAN)			
local	Address	Status	more...
Node	99	OK	>>
node 1 :	1	OK	>>
node 2 :	0	-	>>
node 3 :	0	-	>>
node 4 :	0	-	>>
node 5 :	0	-	>>
node 6 :	0	-	>>
node 7 :	0	-	>>

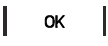

- 25.  Touch the UP or DOWN key to select the device node.
- 26.  Touch the ENTER key: the display will show the main menu of the device.

<c-pro 3 giga>	
Info	
English	
Parameters	
Networks	
Backup/Restore	
Diagnostic	
Debug	

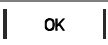

To access a sub-menu:

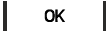
- 27.  Touch the UP or DOWN key to select the sub-menu.
- 28.  Touch the ENTER key.

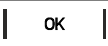

If the display shows the "Input Password" screen:

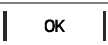
- 29.  Touch the ENTER key again.
- 30.  Touch the UP or DOWN key to set "-19".
- 31.  Touch the ENTER key.

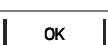

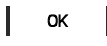

To modify a parameter:

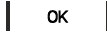
- 32.  Touch the UP or DOWN key to select the parameter.
- 33.  Touch the ENTER key.
- 34.  Touch the UP or DOWN key to set the value.
- 35.  Touch the ENTER key.

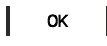

To set the language for viewing the application software:

- 27.  From point 26, touch the UP or DOWN key to select the "Language" menu.
- 28.  Touch the ENTER key.
- 29.  Touch the UP or DOWN key to set the language.
- 30.  Touch the ENTER key.

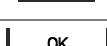

To set the date and time:

- 27.  From point 26, touch the UP or DOWN key to select the date and time.
- 28.  Touch the ENTER key.
- 29.  Touch the UP or DOWN key to set the value.
- 30.  Touch the LEFT or RIGHT key to select another field.
- 31.  Touch the UP or DOWN key to set the value.
- 32.  Touch the ENTER key.

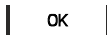
To copy the device configuration onto a USB flash drive:

- 27. From point 26, connect the USB flash drive to the USB port of the device (using the connecting cable 0810500025: see the section *ACCESSORIES*).
- 28.  Touch the UP or DOWN key to select the "Backup/Restore" menu then select "Parameters key" (select "Backup memory" to copy the backup memory).
- 29.  Touch the UP or DOWN key to select "Application par" to copy the application software parameters (select "Hardware config" to copy the configuration parameters).
- 30.  Touch the UP or DOWN key to select "Save on the key".
- 31.  Touch the ENTER key: it will begin copying the configuration.
This normally takes a couple of seconds. If it fails to copy, the system alarm LED will light up and the message "Err" will appear in the configuration parameter "Key Par".
- 32. Disconnect the USB flash drive from the USB port of the device.

To copy the device configuration from a USB flash drive:

27.		From point 26, connect the USB flash drive to the USB port of the device (using the connecting cable 0810500025: see the section <i>ACCESSORIES</i>).
28.		Touch the UP or DOWN key to select the "Backup/Restore" menu then select "Parameters key" (select "Backup memory" to copy the backup memory).
29.		Touch the UP or DOWN key to select "Restore from the key".
30.		Touch the ENTER key: it will begin copying the configuration. This normally takes a couple of seconds. If it fails to copy, the system alarm LED will light up and the message "Err" will appear in the configuration parameter "Key Par".
31.		Disconnect the USB flash drive from the USB port of the device.
32.		Disconnect the device from the mains.
33.		Power up the device.

Copying is possible if the firmware of the device from which it originates and the firmware of the destination device are the same.

To go back to previous displays:

32.		Touch the ON/STAND-BY key a few times.
-----	--	--

7 SIGNALLING LEDS

LED	ON	SLOW FLASH	NORMAL FLASH	RAPID FLASH	OFF
ON	device powered	-	-	-	device not powered
RUN	application software compiled and running in <i>release</i> mode	application software compiled in <i>debug</i> mode	application software running in <i>debug</i> mode	application software compiled, running in <i>debug</i> mode and stopped at a <i>breakpoint</i>	- device not compatible with the application software - device not enabled to work with <i>special ABLs (Application Block Libraries)</i>
	system alarm activated that cannot be reset using the application software	access to the external FLASH memory	system alarm with automatic reset activated	system alarm with manual reset activated	-
CAN	device configured to communicate via CAN with another device but communication non established	-	CAN communication established but not entirely correct	CAN communication established and correct	no CAN communication
L1	can be set with UNI-PRO 3 development environment				

8 CONFIGURATION PARAMETERS

8.1 Configuration parameters of the "Info" menu

PARAMETER	MIN.	MAX.	U.M.	DEF.	DESCRIPTION
PROJ					read-only parameter information concerning the application project (project, version and revision)
FW					read-only parameter information concerning the firmware (code, version, revision and sub-revision)
HW					read-only parameter information concerning the hardware (version, revision, generic (G) or special (S))
SW					read-only parameter information concerning the UNI-PRO 3 development environment (version and revision)
SN					read-only parameter information concerning the serial number and outcome of the production testing
MASK					read-only parameter information concerning the mask (depends on the manufacturer's coding system)
VENDOR ID					read-only parameter identifier
DATE					read-only parameter date and time the application project was last compiled

8.2 Configuration parameters of the "Parameters" menu

PARAMETER	MIN.	MAX.	U.M.	DEF.	DESCRIPTION
AI1	---	---	---	NTC	type of probe analogue input 1 PTC = PTC probe NTC = NTC probe PT1000 = Pt 1000 probe NTCK2 = type 2 NTC probe NTCK3 = type 3 NTC probe RESIST = electrical resistance reading
AI2	---	---	---	NTC	type of probe analogue input 2 PTC = PTC probe NTC = NTC probe PT1000 = Pt 1000 probe NTCK2 = type 2 NTC probe NTCK3 = type 3 NTC probe RESIST = electrical resistance reading
AI3	---	---	---	NTC	type of probe analogue input 3 PTC = PTC probe NTC = NTC probe PT1000 = Pt 1000 probe NTCK2 = type 2 NTC probe NTCK3 = type 3 NTC probe RESIST = electrical resistance reading
AI4	---	---	---	NTC	type of probe analogue input 4 PTC = PTC probe NTC = NTC probe PT1000 = Pt 1000 probe NTCK2 = type 2 NTC probe NTCK3 = type 3 NTC probe RESIST = electrical resistance reading
AI5	---	---	---	NTC	type of probe analogue input 5 PTC = PTC probe NTC = NTC probe PT1000 = Pt 1000 probe NTCK2 = type 2 NTC probe NTCK3 = type 3 NTC probe RESIST = electrical resistance reading
AI6	---	---	---	NTC	type of probe analogue input 6

					PTC = PTC probe NTC = NTC probe 0-20mA = 0-20 mA transducer 4-20mA = 4-20 mA transducer 0-5V = 0-5 V ratiometric transducer 0-10V = 0-10 V transducer PT1000 = Pt 1000 probe NTCK2 = type 2 NTC probe NTCK3 = type 3 NTC probe RESIST = electrical resistance reading
AI7	---	---	---	NTC	type of probe analogue input 7 PTC = PTC probe NTC = NTC probe 0-20mA = 0-20 mA transducer 4-20mA = 4-20 mA transducer 0-5V = 0-5 V ratiometric transducer 0-10V = 0-10 V transducer PT1000 = Pt 1000 probe NTCK2 = type 2 NTC probe NTCK3 = type 3 NTC probe RESIST = electrical resistance reading
AI8	---	---	---	NTC	type of probe analogue input 8 PTC = PTC probe NTC = NTC probe 0-20mA = 0-20 mA transducer 4-20mA = 4-20 mA transducer 0-5V = 0-5 V ratiometric transducer 0-10V = 0-10 V transducer PT1000 = Pt 1000 probe NTCK2 = type 2 NTC probe NTCK3 = type 3 NTC probe RESIST = electrical resistance reading
AI9	---	---	---	NTC	type of probe analogue input 9 PTC = PTC probe NTC = NTC probe 0-20mA = 0-20 mA transducer 4-20mA = 4-20 mA transducer 0-5V = 0-5 V ratiometric transducer 0-10V = 0-10 V transducer PT1000 = Pt 1000 probe NTCK2 = type 2 NTC probe NTCK3 = type 3 NTC probe RESIST = electrical resistance reading
AI10	---	---	---	NTC	type of probe analogue input 10 PTC = PTC probe NTC = NTC probe 0-20mA = 0-20 mA transducer 4-20mA = 4-20 mA transducer 0-5V = 0-5 V ratiometric transducer 0-10V = 0-10 V transducer PT1000 = Pt 1000 probe NTCK2 = type 2 NTC probe NTCK3 = type 3 NTC probe RESIST = electrical resistance reading
AI11	---	---	---	NTC	type of probe analogue input 11 PTC = PTC probe NTC = NTC probe PT1000 = Pt 1000 probe NTCK2 = type 2 NTC probe NTCK3 = type 3 NTC probe RESIST = electrical resistance reading
AI12	---	---	---	NTC	type of probe analogue input 12

					PTC = PTC probe NTC = NTC probe PT1000 = Pt 1000 probe NTCK2 = type 2 NTC probe NTCK3 = type 3 NTC probe RESIST = electrical resistance reading
AI13	---	---	---	NTC	type of probe analogue input 13 PTC = PTC probe NTC = NTC probe PT1000 = Pt 1000 probe NTCK2 = type 2 NTC probe NTCK3 = type 3 NTC probe RESIST = electrical resistance reading
AI14	---	---	---	NTC	type of probe analogue input 14 PTC = PTC probe NTC = NTC probe 0-20mA = 0-20 mA transducer 4-20mA = 4-20 mA transducer 0-5V = 0-5 V ratiometric transducer 0-10V = 0-10 V transducer PT1000 = Pt 1000 probe NTCK2 = type 2 NTC probe NTCK3 = type 3 NTC probe RESIST = electrical resistance reading
AI15	---	---	---	NTC	type of probe analogue input 15 PTC = PTC probe NTC = NTC probe 0-20mA = 0-20 mA transducer 4-20mA = 4-20 mA transducer 0-5V = 0-5 V ratiometric transducer 0-10V = 0-10 V transducer PT1000 = Pt 1000 probe NTCK2 = type 2 NTC probe NTCK3 = type 3 NTC probe RESIST = electrical resistance reading
AI16	---	---	---	NTC	type of probe analogue input 16 PTC = PTC probe NTC = NTC probe 0-20mA = 0-20 mA transducer 4-20mA = 4-20 mA transducer 0-5V = 0-5 V ratiometric transducer 0-10V = 0-10 V transducer PT1000 = Pt 1000 probe NTCK2 = type 2 NTC probe NTCK3 = type 3 NTC probe RESIST = electrical resistance reading
AI Err Time	0	240	s	2	analogue inputs timeout (when this time has elapsed with no communication with an analogue input, the controller signals the analogue input error)
AO1	---	---	---	0-10V	type of signal analogue output 1 0-10V = 0-10 V PWM = PWM (Pulse With Modulation)
freq	10	2000	Hz	1000	frequency of PWM signal of analogue output 1
AO2	---	---	---	0-10V	type of signal analogue output 2 0-10V = 0-10 V PWM = PWM (Pulse With Modulation)
freq	10	2000	Hz	1000	frequency of PWM signal of analogue output 2
AO3	---	---	---	0-10V	type of signal analogue output 3 0-10V = 0-10 V PWM = PWM (Pulse With Modulation)

freq	10	2000	Hz	1000	frequency of PWM signal of analogue output 3
AO4	- - -	- - -	- - -	0-10V	type of signal analogue output 4 0-10V = 0-10 V PWM = PWM (Pulse With Modulation)
freq	10	2000	Hz	1000	frequency of PWM signal of analogue output 4
AO5	- - -	- - -	- - -	0-10V	type of signal analogue output 5 0-10V = 0-10 V PWM = PWM (Pulse With Modulation)
freq	10	2000	Hz	1000	frequency of PWM signal of analogue output 5
AO6	- - -	- - -	- - -	0-10V	type of signal analogue output 6 0-10V = 0-10 V PWM = PWM (Pulse With Modulation)
freq	10	2000	Hz	1000	frequency of PWM signal of analogue output 6
AO7	- - -	- - -	- - -	0-10V	type of signal analogue output 7 0-10V = 0-10 V PWM = PWM (Pulse With Modulation)
freq	10	2000	Hz	1000	frequency of PWM signal of analogue output 7
AO8	- - -	- - -	- - -	0-10V	type of signal analogue output 8 0-10V = 0-10 V PWM = PWM (Pulse With Modulation)
freq	10	2000	Hz	1000	frequency of PWM signal of analogue output 8
AI1 filter	OFF	ON	- - -	ON	coefficient of analogue input 1 filter
AI2 filter	OFF	ON	- - -	ON	coefficient of analogue input 2 filter
AI3 filter	OFF	ON	- - -	ON	coefficient of analogue input 3 filter
AI4 filter	OFF	ON	- - -	ON	coefficient of analogue input 4 filter
AI5 filter	OFF	ON	- - -	ON	coefficient of analogue input 5 filter
AI6 filter	OFF	ON	- - -	ON	coefficient of analogue input 6 filter
AI7 filter	OFF	ON	- - -	ON	coefficient of analogue input 7 filter
AI8 filter	OFF	ON	- - -	ON	coefficient of analogue input 8 filter
AI9 filter	OFF	ON	- - -	ON	coefficient of analogue input 9 filter
AI10 filter	OFF	ON	- - -	ON	coefficient of analogue input 10 filter
AI11 filter	OFF	ON	- - -	ON	coefficient of analogue input 11 filter
AI12 filter	OFF	ON	- - -	ON	coefficient of analogue input 12 filter
AI13 filter	OFF	ON	- - -	ON	coefficient of analogue input 13 filter
AI14 filter	OFF	ON	- - -	ON	coefficient of analogue input 14 filter
AI15 filter	OFF	ON	- - -	ON	coefficient of analogue input 15 filter
AI16 filter	OFF	ON	- - -	ON	coefficient of analogue input 16 filter
DI filter	OFF	ON	- - -	ON	coefficient of digital inputs
En. Prg Level ⁽¹⁾	- - -	- - -	- - -	NO	enable access to the first page of the level by pressing a combination of keys YES = yes, proceeding as follow: - hold down the ENTER key for 3 s to access the first page of level 1 - hold down the ENTER and ESC keys for 3 s to access the first page of level 2 - hold down the LEFT and RIGHT keys for 3 s to access the first page of level 3
Password indi ⁽¹⁾	- - -	- - -	- - -	NO	password requirement for access to the different levels NO = it is not necessary to set a password to access levels

					lower than that which has already been accessed YES = it is necessary to set a password to access each level
Ena BkMem RTC (1)	---	---	---	YES	enable the clock and backup memory functions

8.3 Configuration parameters of the "CAN Bus" sub-menu of the "Networks" menu

PARAMETER	MIN.	MAX.	U.M.	DEF.	DESCRIPTION
MyNode	1	127	---	1	address of local CAN node, that is of the device
Master	---	---	---	YES	enable master function in a CAN network YES = yes
Baud	---	---	---	20K	baud rate of the CAN communication 20K = 20,000 baud 50K = 50,000 baud 125K = 125,000 baud 500K = 500,000 baud
Timeout	1	60	s	5	timeout of the remote CAN communication, that is with the other elements of the network (when the time set by this parameter has elapsed with no CAN communication with an element, the element is disabled)
Network Node	[1] 0	[32] 127	---	[1] 99	address of remote CAN nodes, that is of the other elements in the network (example for [1] 2) [1] = node 2 = node address
TSEG1	---	---	---	---	unused
TSEG2	---	---	---	---	unused
SJW	---	---	---	---	unused
BTR	---	---	---	---	unused
Status	read-only parameter				CAN machine status INIT = initialisation STOPPED = stop CAN OPERAT = operational PRE-OP = in pre-operational status
Bus Status	read-only parameter				CAN bus status OK = status OK WARNING = warning PASSIVE = bus in receive mode only BUS OFF = bus off
Cnt Rx	read-only parameter				number of packages received
Cnt Tx	read-only parameter				number of packages transmitted
Cnt Ovf	read-only parameter				number of overflow packages
Cnt Passive	read-only parameter				number of passive transactions
Cnt Bus Off	read-only parameter				number of Bus off status transactions

8.4 Configuration parameters of the "UART1" sub-menu of the "Networks" menu

The parameters are only visible if the application software is set up for the RS-485 (MODBUS MASTER/SLAVE, BACnet MS/TP) port to be configured to support the MODBUS communication protocol.

PARAMETER	MIN.	MAX.	U.M.	DEF.	DESCRIPTION
Address	1	247	---	1	device MODBUS address (important only if the communication protocol is MODBUS slave)
Baud rate	---	---	---	9600	baud rate of the MODBUS communication 1200 = 1,200 baud

					2400 = 2,400 baud 4800 = 4,800 baud 9600 = 9,600 baud 19200 = 19,200 baud 28800 = 28,800 baud 38400 = 38,400 baud 57600 = 57,600 baud
Parity	---	---	---	EVEN	parity of the MODBUS communication NONE = none ODD = odd EVEN = even
Stop	---	---	---	1 BIT	number of stop bit of the MODBUS communication 1 BIT = 1 bit 2 BIT = 2 bit
Timeout	2	240	s	10	timeout of the local MODBUS communication, that is of the device (when the time set by this parameter from the sending of the request has elapsed without receiving an answer, the sending of the request is considered to have failed and the next request is sent; this is important only when the communication protocol is MODBUS master)

8.5 Configuration parameters of the "UART2" sub-menu of the "Networks" menu

The parameters are only visible if the application software is set up for the RS-485 MODBUS slave port to be configured to support the MODBUS communication protocol.

PARAM.	MIN.	MAX.	U.M.	DEF.	DESCRIPTION
Address	1	247	---	1	device MODBUS address (important only if the communication protocol is MODBUS slave)
Baud rate	---	---	---	9600	baud rate of the MODBUS communication 1200 = 1,200 baud 2400 = 2,400 baud 4800 = 4,800 baud 9600 = 9,600 baud 19200 = 19,200 baud 28800 = 28,800 baud 38400 = 38,400 baud 57600 = 57,600 baud
Parity	---	---	---	EVEN	parity of the MODBUS communication NONE = none ODD = odd EVEN = even
Stop	---	---	---	1 BIT	number of stop bit of the MODBUS communication 1 BIT = 1 bit 2 BIT = 2 bit
Timeout	0	9999	ms	1000	timeout of the local MODBUS communication, that is of the device (when the time set by this parameter from the sending of the request has elapsed without receiving an answer, the sending of the request is considered to have failed and the next request is sent; this is important only when the communication protocol is MODBUS master)

8.6 Configuration parameters of the "Ethernet" sub-menu of the "Networks" menu

PARAM.	MIN.	MAX.	U.M.	DEF.	DESCRIPTION
MAC	read-only parameter				unused
Eth IP	---	---	---	192.168.0.2	IP address
Subnet Mask	----	----	----	255.255.255.0	subnet mask
Adr Gateway	----	----	----	192.168.0.1	gateway address
Port MB Slave	---	---	---	---	MODBUS slave port
MB Master Port	---	---	---	---	MODBUS master port

Web Server Port	---	---	---	---	Web Server port
-----------------	-----	-----	-----	-----	-----------------

8.7 Configuration parameters of the "USB" sub-menu of the "Networks" menu

PARAM.	MIN.	MAX.	U.M.	DEF.	DESCRIPTION
USB Status Device	read-only parameter				unused
Device Status Idle Speed	read-only parameter				unused

8.8 Configuration parameters of the "Password" menu

PARAM.	MIN.	MAX.	U.M.	DEF.	DESCRIPTION
Level 1:	-32768	32768	---	0	value of password to access level 1
	---	---	---	ON	enable password to access level 1 OFF = it is not necessary to set a password to access level 1 ON = it is necessary to set a password to access level 1
Level 2:	-32768	32768	---	0	value of password to access level 2
	---	---	---	ON	enable password to access level 2 OFF = it is not necessary to set a password to access level 2 ON = it is necessary to set a password to access level 2
Level 3:	-32768	32768	---	0	value of password to access level 3
	---	---	---	ON	enable password to access level 3 OFF = it is not necessary to set a password to access level 3 ON = it is necessary to set a password to access level 3
Level 4:	-32768	32768	---	0	value of password to access level 4
	---	---	---	ON	enable password to access level 4 OFF = it is not necessary to set a password to access level 4 ON = it is necessary to set a password to access level 4
Level 5:	-32768	32768	---	0	value of password to access level 5
	---	---	---	ON	enable password to access level 5 OFF = it is not necessary to set a password to access level 5 ON = it is necessary to set a password to access level 5
Timeout	0	240	s	240	timeout of the passwords to access the levels (when this time has elapsed from the last time the keys were pressed, it is necessary to reset the password, if required, to access the level)

8.9 Configuration parameters of the "Diagnostics" menu

PARAM.	MIN.	MAX.	U.M.	DEF.	DESCRIPTION
Memory					status of non-volatile memory OK = no error ERR = error
RTC					clock status OK = no error ERR = error LOW = data loss DISAB = disabled
STACK					stack status OK = no error ERR = error (due to overflow)
5V RATIO					status of the power supply voltage of the ratiometric transducers OK = no error ERR = error (due to voltage outside range)
12V MEASURE					measurement of power supply voltage of the 0-20 mA, 4-20 mA and 0-10 V transducers OK = no error ERR = error (due to voltage outside range)
MATH					math status OK = no error ERR = error (due to overflow, underflow, dividing by zero or NaN)
KEY PAR					outcome of upload or download of the application software or configuration parameters using the USB flash drive OK = operation successfully completed ERR = operation not successfully completed
DATALOG					data logger status DISABLE = disabled OK_STOP = no error and not operative OK_START = no error and operative ERR = in errore
IO EXP					I/O expansion status ENABLE = enabled DISABLE = disabled

8.10 Configuration parameters of the "Debug" menu

PARAM.	MIN.	MAX.	U.M.	DEF.	DESCRIPTION
Main run time				read-only parameter	main run time of the application software (in ms)
max main time				read-only parameter	maximum main run time of the application software (in ms)
free stack main				read-only parameter	minimum value of free stack of the main (in bytes)
100ms run time				read-only parameter	run time of the application software programmed for every 100 ms
100 ms max time				read-only parameter	maximum run time of the application software programmed for every 100 ms
free stack 100 ms				read-only parameter	free stack of the interrupt time at 100 ms of the application software (in bytes)
5V PROBE				read-only parameter	measurement of the power supply voltage of the ratiometric transducers
VBUS				reserved	reserved
VREF				reserved	reserved

NOTES

⁽¹⁾ press the RIGHT key to view the parameter.

9 ACCESSORIES

9.1 Connecting cable for Personal Computer

0810500023

Makes it possible to connect to a personal computer using a USB.
Length: 1 m (3.28 ft).



9.2 Connecting cable for USB flash drive

0810500025

Allows a USB flash drive to be connected. Length: 2 m (3.28 ft).



9.3 RS-485/USB serial interface

EVIF20SUXI

Makes it possible to connect to the Parameters Manager setup software system.



9.4 INTRABUS/RS-485 serial interface

EVIF22ISX

Makes it possible to convert the INTRABUS signal into an RS-485 MODBUS signal.



9.5 EVlink TTL/BLE module

EVIF25TBX

Makes BLE connectivity through the TTL MODBUS possible.



9.6 EVlink TTL/Wi-Fi module

EVIF25TWX

Makes Wi-Fi connectivity through the TTL possible.



9.7 USB flash drive

EVUSB4096M

For uploading and downloading data.
4 GB of memory.



9.8 Connection kit

CJAV47

Allows cabling in standard controllers with housing.



9.9 Connection kit

CJAV52

Allows cabling in plus controllers.



10 TECHNICAL SPECIFICATIONS

Purpose of the control device	Function controller	
Construction of the control device	Built-in electronic device	
Housing	Grey, self-extinguishing	
Category of heat and fire resistance	D	
Measurements		
10 DIN modules: 179.0 x 110.0 x 26.0 mm (7 1/16 x 1 5/16 x 1 in) for open frame models	10 DIN modules: 179.0 x 128.0 x 60.0 mm (7 1/16 x 1 1/16 x 1 3/16 in) for models with housing	
Mounting methods for the control device	On a DIN rail in a control panel	
Degree of protection provided by the casing		
IP00 open frame models	IP40 front of models with housing	
Connection method		
Fixed screw terminal blocks for wires up to 1.5 mm ² and 2.5 mm ² for open frame models	Plug-in screw terminal blocks for wires up to 1.5 mm ² and 2.5 mm ² for models with housing	Plug-in clamp terminal blocks for wires up to 1.5 mm ² for plus controllers
Pico-Blade connector	Micro-USB connector	RJ45 F telephone connector (depending on model)
Maximum permitted length for connection cables		
Power supply: 10 m (32.8 ft)	Analogue inputs: 10 m (32.8 ft)	
Auxiliary power supply and 0-5 V ratiometric transducer power supply: 10 m (32.8 ft)	Digital inputs: 10 m (32.8 ft)	
Analogue outputs 0-10 V: 10 m (32.8 ft)	PWM analogue outputs: 1 m (3.28 ft)	
Digital outputs: 100 m (328 ft)	INTRABUS port: 10 m (32.8 ft)	
RS-485 MODBUS port: 1,000 m (3,280 ft)	USB port: 1 m (3.28 ft)	
CAN port: - 1,000 m (3,280 ft), baud rate: 20,000 baud - 500 m (1,640 ft), baud rate: 50,000 baud - 250 m (820 ft), baud rate: 125,000 baud - 50 m (164 ft), baud rate: 500,000 baud		
Operating temperature	From -10 to 55 °C (from 14 to 131 °F)	
Storage temperature	From -20 to 70 °C (from -4 to 158 °F)	
Operating humidity	Relative humidity without condensate from 5 to 95 %	
Pollution status of the control device	2	
Compliance		
RoHS 2011/65/EC	WEEE 2012/19/EU	REACH (EC) Regulation no. 1907/2006
EMC 2014/30/EU	LVD 2014/35/EU	
Power supply	115... 230 VAC (+10 % -15 %), 50/60 Hz (±3 Hz), max. 16 VA, 20 VA for plus controllers	
Earthing methods for the control device	None	
Rated impulse-withstand voltage	2.5 KV	
Over-voltage category	II	
Software class and structure	A	
Clock	With secondary lithium battery	
Clock drift	≤ 30 s/month at 25 °C (77 °F)	
Clock battery autonomy in the absence of a power supply	> 6 months at 25 °C (77 °F)	
Clock battery charging time	24 h (the battery is charged by the power supply of the device)	
Analogue inputs		

5 for PTC, NTC or Pt 1000 probes, 8 for plus controllers (can be configured also for dry contact digital input)		5 for PTC, NTC or Pt 1000 probes, 0-5 V, 0-10 V, 0-20 mA or 4-20 mA transducers, 8 for plus controllers (can be configured also for dry contact digital input)
PTC probes	Sensor type	KTY 81-121 (990 Ω @ 25 °C, 77 °F)
	Measurement field	From -50 to 150 °C (from -58 to 302 °F)
	Resolution	0.1 °C (1 °F)
	Precision	±1 °C
NTC probes	Sensor type	β3435 (10 KΩ @ 25 °C, 77 °F)
	Measurement field	From -50 to 120 °C (from -58 to 248 °F)
	Resolution	0.1 °C (1 °F)
	Precision	±1 °C
Pt 1000 probes	Sensor type	1 KΩ @ 0 °C, 32 °F
	Measurement field	From -100 to 400 °C (from -148 to 752 °F)
	Resolution	1 °C (1 °F)
	Precision	±2.5 °C
0-5 V transducers	Input resistance	≥ 10 KΩ
	Resolution	0.01 V
	Precision	±50 mV
0-10 V transducers	Input resistance	≥ 10 KΩ
	Resolution	0.01 V
	Precision	±50 mV
0/4-20 mA transducers	Input resistance	≤ 200 Ω
	Resolution	0.01 mA
	Precision	±0.1 mA
Power supply remote user interfaces	13 VDC, +20 % -10 %, 150 mA max.	
Power supply transducers	13 VDC, +20 % -10 %, 100 mA max. (+40 mA max. for plus controllers)	
Power supply 0-5 V ratiometric transducers	5 VDC, ±10 %, 20 mA max. (+10 mA max. for plus controllers)	
Digital inputs		
3 dry contact and for pulse trains up to 2 KHz		2 high voltage
Dry contact	Contact type	3.3 VDC, 1 mA
	Power supply	None
High voltage contact	Power supply	115... 230 VAC
Analogue outputs	4 for 0-10 V or PWM signal, 8 for plus controllers	
0-10 V signal	Minimum applicable impedance	1 KΩ
	Resolution	0.01 V
PWM signal	Power supply	0... 10 VDC, max. 10 mA
	Frequency	10 Hz... 2 KHz
	Duty	0... 100 %
	Resolution	1% up to 500 Hz, 5% up to 2 KHz
Digital outputs	2 with SPST electro-mechanical relay, 2 A res. @ 250 VAC, 6 for plus controllers	
	5 with SPST electro-mechanical relay, 3 A res. @ 250 VAC	
	1 with SPDT electro-mechanical relay, 3 A res. @ 250 VAC, 2 for plus controllers	
	1 with SPST electro-mechanical relay, 8 A res. @ 250 VAC	

The device guarantees:

- reinforced insulation between the SELV circuits and relay outputs
- reinforced insulation between the "groups" of relay outputs
- main insulation between relay outputs of the same group
- reinforced insulation between the powered parts and the SELV circuits
- reinforced insulation between "group 1" of relay outputs (K1... K3) and the high voltage digital inputs (DIHV1 and DIHV2)
- main insulation between the powered parts of opposite polarity (line-neutral)

Type 1 or Type 2 actions	Type 1
Additional features of Type 1 or Type 2 actions	C
Communications ports	
1 TTL MODBUS port	1 INTRABUS port (RS-485 MODBUS master/slave using the serial interface EVIF22ISX)
1 RS-485 MODBUS slave port	1 RS-485 (MODBUS master/slave, BACnet MS/TP) port
1 CAN port	1 USB port

Depending on the model, 1 Ethernet (MODBUS TCP, WebServer, BACnet IP) port

The BACnet communication protocol is an alternative to the Web Server function.

The current UNI-PRO 3.16 version uses a standard BACnet® B-ASC device profile. Management of the Scheduler and Calendar objects is not included in this profile, while it is in the B-AAC profile.

c-pro 3 giga

Programmable controllers (up to 43 I/O)

PT - 47/20

Code 144CP3GI204

This document and the solutions contained therein are the intellectual property of EVCO and thus protected by the Italian Intellectual Property Rights Code (CPI). EVCO imposes an absolute ban on the full or partial reproduction and disclosure of the content other than with the express approval of EVCO. The customer (manufacturer, installer or end user) assumes all responsibility for the configuration of the device. EVCO accepts no liability for any possible errors in this document and reserves the right to make any changes at any time without prejudice to the essential functional and safety features of the equipment.



EVCO S.p.A.

Via Feltre 81, 32036 Sedico (BL) ITALY

phone +39 0437 8422 **fax** +39 0437 83648

email info@evco.it **web** www.evco.it