



EVF815

**Split execution controller for
temperature-controlled blast chillers
(with capacitive touch-key user interface,
which can be integrated into the unit)**



ENGLISH

INSTALLER MANUAL ver. 2.0

CODE 144F815E204

Important

Important

Read this document thoroughly before installation and before use of the device and follow all recommendations; keep this document with the device for future consultation.

The following symbols support reading of the document:

💡 indicates a suggestion

⚠ indicates a warning

The device must be disposed of in compliance with local Standards regarding the collection of electric and electronic equipment.



Index

1	INTRODUCTION	5
1.1	Introduction	5
1.2	Summary table of the main features and the models available.....	6
2	DESCRIPTION.....	9
2.1	Description of the user interface	9
2.2	Description of the control module.....	10
3	DIMENSIONS AND INSTALLATION.....	11
3.1	User interface dimensions	11
3.2	Control module dimensions	11
3.3	User interface installation.....	12
3.4	Control module installation.....	12
3.5	Installation warnings	12
4	ELECTRIC CONNECTION.....	13
4.1	Electric connection	13
4.1.1	Connection of the terminating resistors	14
4.2	Warnings for the electric connection	14
5	USER INTERFACE	15
5.1	Foreword	15
5.2	Switching the device on/off	15
5.3	The display.....	15
5.4	Cabinet temperature display.....	15
5.5	Display of the temperature detected by the needle probe.....	16
5.6	Evaporator temperature display	16
5.7	Defrosting activation in manual mode.....	16
5.8	Switch-on/off of the cabinet light in manual mode.....	16
5.9	Locking/unlocking the keyboard.....	17
5.10	Silencing the buzzer	17
6	OPERATION.....	18
6.1	Foreword	18
6.2	Blast chilling and storage	18
6.3	Hard blast chilling and storage.....	19
6.4	Deep freezing and storage	21
6.5	Soft deep freezing and storage	22
6.6	Pre-cooling start-up.....	24
6.7	Management of the test regarding correct insertion of the needle probe.....	24
6.8	Switching on UV light for sterilisation cycle.....	25
6.9	Heating the needle probe	25
7	“HACCP” FUNCTION.....	26
7.1	Foreword	26
7.2	Display of information relative to the HACCP alarms	26
7.3	Deleting the information relative to the HACCP alarms.....	27
8	COMPRESSOR OPERATING HOURS COUNT	28
8.1	Display of compressor operating hours	28
8.2	Deleting the compressor operating hours	28
9	CONFIGURATION	29
9.1	Setting the real date and time	29
9.2	Setting the configuration parameters.....	29

9.3	Restoring the factory settings	30
9.4	List of configuration parameters.....	30
10	SIGNALS AND INDICATIONS	41
10.1	Signals.....	41
10.2	Indications	43
11	ALARMS	44
11.1	Alarms	44
12	ERRORS.....	46
12.1	Errors	46
13	ACCESSORIES	48
13.1	EVKEY programming key	48
13.1.1	Introduction.....	48
13.1.2	Description	48
13.1.3	Dimensions.....	49
13.1.4	Uploading the configuration parameters	49
13.1.5	Downloading the configuration parameters	49
13.2	Non-optoisolated RS-485/TTL serial interface EVIF20TSX	50
13.2.1	Introduction.....	50
13.2.2	Description	50
13.2.3	Dimensions.....	50
13.2.4	Connection to the device	50
13.3	EVPROG01 connection kit.....	51
13.3.1	Introduction.....	51
13.3.2	Description	51
13.3.3	Dimensions.....	52
13.3.4	Connection to the device	53
14	TECHNICAL DATA.....	54
14.1	Technical data	54

1 INTRODUCTION

1.1 Introduction

EVF815 is a digital controller studied to manage temperature-controlled blast chillers, which can be mechanically and aesthetically integrated into the unit.

The controller is fitted with:

- clock
- signal buzzer and alarm
- 3 analogue inputs (cabinet probe, needle probe and evaporator probe) for PTC/NTC probes
- 2 digital inputs (door micro switch and high pressure)
- 5 digital outputs (electromechanical relays), 1 x 30 A res. @ 250 VAC for compressor management, 2 x 16 A res. @ 250 VAC for management or defrosting and a utility set for door heating elements or the condenser fan, 2 x 8 A res. @ 250 VAC for management of the evaporator fan and a fifth utility that can be set for the cabinet light, needle probe heating or UV light; defrosting can be electric, hot air, air or air with door open
- serial port with MODBUS communication protocol.

The device can manage both temperature and timed blast chilling and storage cycles and deep freezing and storage cycles and also the hard and soft types.

Every operating cycle can be preceded by pre-cooling; the temperature-controlled cycles are also preceded by a two-stage test for verification of the correct insertion of the needle probe.

The device is available in "split" execution (user interface + control module).

The user interface is behind a Plexiglas sheet and is made up from a custom 4 digit display (with function icons) and 6 capacitive touch-keys; installation is envisioned on rear of panel with biadhesive tape.

The control module is without cover and installation is envisioned on flat surface with spacers.

Via the "HACCP" function, up to 9 events can be memorised for each of the 3 HACCP alarms (temperature-controlled blast chilling or deep freezing not concluded within the maximum duration alarm, maximum temperature during storage alarm and power cut during storage alarm); the critical value, date and time at which the alarm occurred and the duration can be memorised for each HACCP alarm.

The configuration parameters can be uploaded and downloaded using the EVKEY programming key (to be ordered separately).

Via a serial interface (to be ordered separately), it is also possible to connect the controller to the Parameters Manager set-up software system, to the monitoring and surveillance system of the RICS plants or to the data recording device, to download the recorded data (via USB), to upload and download EVUSBREC01 configuration parameters.

The following are indicated among the many other features:

- IP65 protection rating of the user interface
- direct loads connection (except the utility managed by the fifth digital output)
- management of three types of backlight
- memorisation of the defrosting interval
- management of temperature alarms
- compressor operating hours count
- "keyboard lock" function.

1.2 Summary table of the main features and the models available

The following table illustrates the main features of the device and the models available.

" / " indicates the feature can be set via a configuration parameter.

User interface (without cover)	EVF815
290.0 x 50.5 mm (11.417 x 1.988 in; L x H)	•
custom 4 digit display (with function icon)	•
number of keys (capacitive touch-key type)	6
°C decimal point	•
Control module (without cover)	EVF815
99.0 x 108.0 mm (3.897 x 10.798 cm; L x H)	•
Connections	EVF815
faston + fixed screw terminal board	•
Power supply	EVF815
115... 230 VAC	•
Analogue inputs	EVF815
cabinet probe	PTC/NTC
needle probe	PTC/NTC
evaporator probe	PTC/NTC
Digital inputs (for NO/NC contact)	EVF815
door micro switch	•
high pressure	•
Digital outputs (electromechanical relays; A res. @ 250 VAC)	EVF815
compressor	30 A
defrosting	16 A

evaporator fan	8 A
door heating elements/condenser fan	16 A
cabinet light/needle probe heating/UV light	8 A
Communication port	EVF815
serial port with MODBUS communication protocol	•
Other features	EVF815
protection rating of the user interface	IP65
clock	•
signal buzzer and alarm	•
direct loads connection	except for the utility managed by the fifth digital output
management of three types of backlight	•
management of blast chilling and storage/deep freezing and storage cycles	•
management of temperature/time controlled operation cycles	•
hard/soft operating cycles management	•
management of the test regarding correct insertion of the needle probe	•
memorisation of the defrosting interval	•
management of temperature alarms	•
compressor operating hours count	•
"HACCP" function	•
"keyboard lock" function	•
configuration parameters access password	•
restoring the factory settings	•

Codes	EVF815
codes	EVF815P9

For further information, see chapter 14 "TECHNICAL DATA"; for other models contact the Evco sales network.

2 DESCRIPTION

2.1 Description of the user interface

The following drawing illustrates the aspect of the EVF815 user interface.

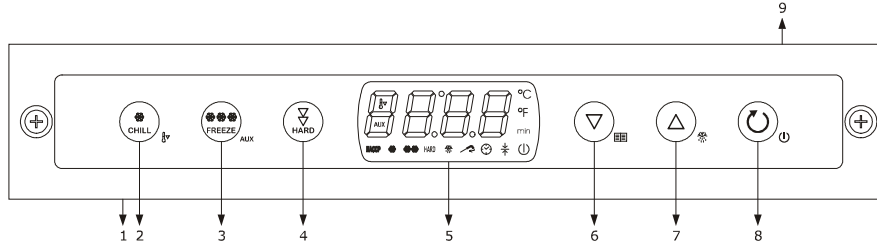

The following table illustrates the meaning of EVF815 user interface parts.

Part	Meaning
1	communication port with the control module (signal)
2	blast chilling key
3	defrosting/auxiliary key, hereon also called "DEEP FREEZING key"
4	hard blast chilling or soft deep freezing key, hereon called "HARD/SOFT" key
5	display
6	decrease key, hereon call "DOWN key"
7	increase key, hereon call "UP key"
8	switch-on/switch-off/cycle start/cycle cut-off key, hereon called "START/STOP key"
9	communication port with the control module (power supply)

For further information, see the next chapters.

2.2 Description of the control module

The following drawing illustrates the aspect of the EVF815 control module.

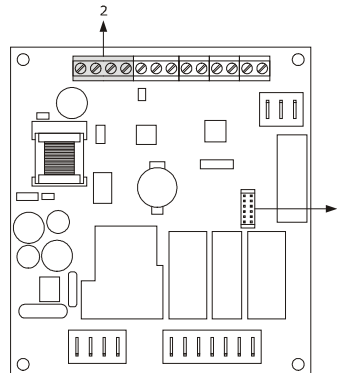

The following table illustrates the meaning of EVF815 control module parts.

Part	Meaning
1	serial port with MODBUS communication protocol
2	communication port with the user interface (signal and power supply)

For further information, see the next chapters.

3 DIMENSIONS AND INSTALLATION

3.1 User interface dimensions

The following drawing illustrates the EVF815 user interface dimensions; these are expressed in mm (in).

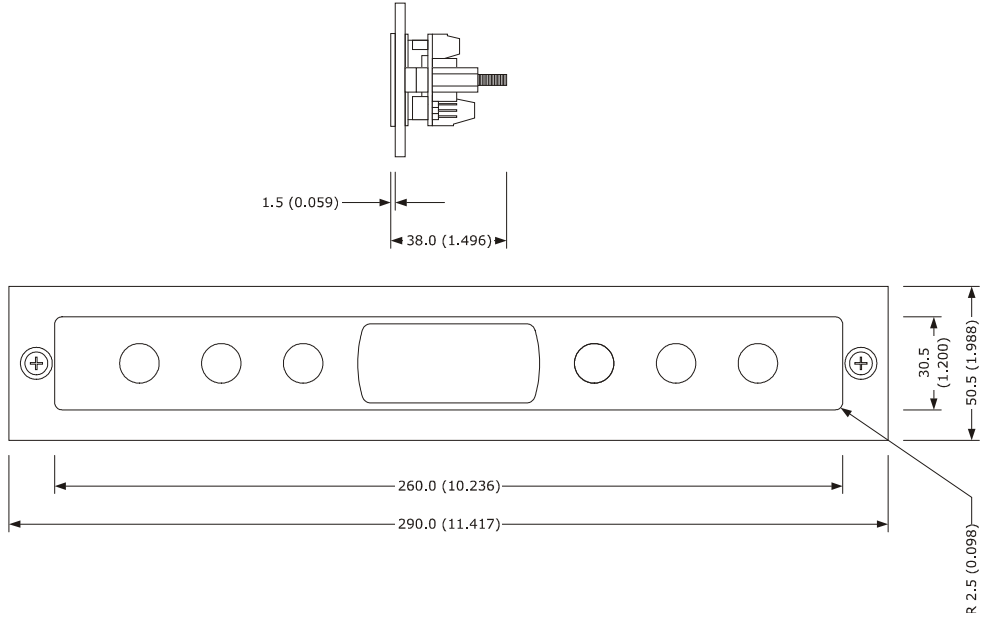

3.2 Control module dimensions

The following drawing illustrates the EVF815 control module dimensions; these are expressed in mm (in).

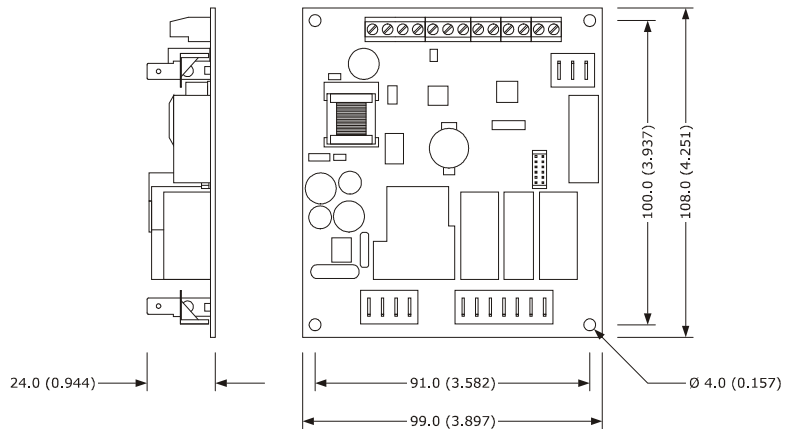

3.3 User interface installation

Rear of panel, with biadhesive tape.

3.4 Control module installation

On flat surface, with spacers.

3.5 Installation warnings

- make sure that the device work conditions (temperature of use, humidity, etc.) lie within the limits indicated; see chapter 14 "TECHNICAL DATA"
- do not install the device near to any heat sources (heating elements, hot air ducts etc.), equipment containing powerful magnets (large diffusers, etc), areas affected by direct sunlight, rain, humidity, excessive dust, mechanical vibrations or shocks.
- any metal parts in proximity of the control module must be at a distance such that they do not compromise the safety distances.
- make sure the display is perfectly adherent to the methacrylate
- in compliance with Safety Standards, the device must be installed correctly and in a way to protect against any contact with electric parts; all parts that ensure protection must be fixed in a way that they cannot be removed without the use of tools.

4 ELECTRIC CONNECTION

4.1 Electric connection

The following drawing illustrates the EVF815 electric connection.

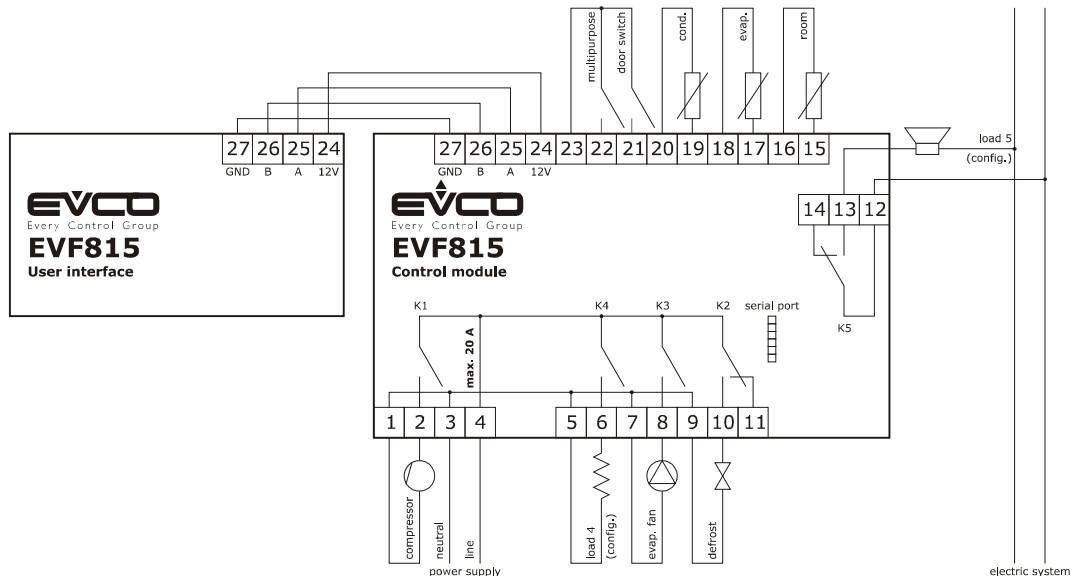

💡 The utility managed by the K4 output, depends on parameter $u1$, as follows:

- door heating elements ($u1 = 0$, pre-defined setting)
- condenser fan ($u1 = 1$).

For the settings relative to the parameters, see chapter 9 "CONFIGURATION".

💡 The utility managed by the K5 output, depends on parameter $u11$, as follows:

- cabinet light ($u11 = 0$, pre-defined setting)
- needle probe heating ($u11 = 1$)
- UV light ($u11 = 2$).

For the settings relative to the parameters, see chapter 9 "CONFIGURATION".

⚠ The serial port is for the connection of the controller to the following additional products:

- EVKEY programming key
- Parameters Manager set-up software system
- RICS plants monitoring and surveillance systems
- Device for recording data, for downloading the data recorded (via USB), for uploading and downloading EVUSBREC01 configuration parameters.

The port must not be used simultaneously with more than one of these products.

4.1.1 Connection of the terminating resistors

The terminating resistor must be connected in order to reduce the reflections on the signal transmitted along the cables that connect the user interface to the control model.

To connect the terminating resistors, position the jumper as illustrated in the following drawing.

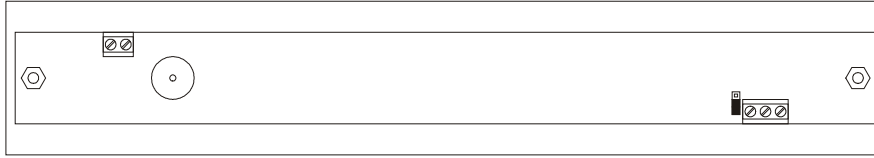

To disconnect the terminating resistors, position the jumper as illustrated in the following drawing.

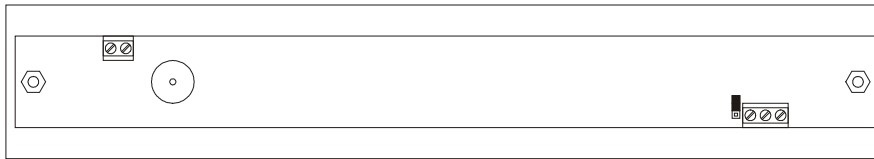

4.2 Warnings for the electric connection

- do not use electric or pneumatic screwdrivers on the device terminal board
- if the device has been taken from a cold to hot place, humidity could condense inside; wait about 1 hour before powering it
- make sure that the power supply voltage, the frequency and the operational electric power of the device, correspond with those of the local power supply; see chapter 14 "TECHNICAL DATA"
- disconnect the device power supply before proceeding with any type of maintenance
- do not use this device as a safety device
- for repairs and information regarding the device, contact the EVCO sales network.

5 USER INTERFACE

5.1 Foreword

The following operating status exist:

- the "off" status (the device is not powered)
- the "stand-by" status (the device is powered and is off)
- the "on" status (the device is powered, is on and is in stand-by for the start-up of an operating cycle)
- the "run" status (the device is powered, is on and an operating cycle is in progress).

Hereon, the term "device switch-on" means the passage from the "stand-by" status to the "on" status. The term "switch-off" means passage from the "on" status to the "stand-by" status.

If a power cut occurs during the "stand-by" status or during the "on" status, the device will repropose the same status when the power supply is restored.

If a power cut occurs during the "run" status, the device will operate as follows when the power supply is restored:

- if a temperature-controlled blast chilling or deep freezing operation was in progress, these will be started again from the beginning
- if a timed-controlled blast chilling or deep freezing operation was in progress, these will be started again from the moment the power supply was cut-off
- if storage was in progress, this will be re-proposed.

5.2 Switching the device on/off

Operate as follows:

1. Make sure that the keyboard is not locked and that no procedure is in progress.
2. Hold the START/STOP key down for 1 s: the  LED will switch on/off.

5.3 The display

The display is off during the "off" status and during the "stand-by" status.

The display shows the cabinet temperature during the "on" status.

The device will operate as follows during the "run" status:

- if a temperature-controlled blast chilling or deep freezing operation is in progress, the display will show the temperature detected by the needle probe
- if a time-controlled blast chilling or deep freezing operation is in progress, the display will show the residual time of the duration of the same
- if storage is in progress, the display will show the cabinet temperature.

5.4 Cabinet temperature display

Operate as follows:

1. Make sure that the keyboard is not locked and that no procedure is in progress.
2. Hold the DOWN key down for 1 s: the display will show the first label available.
3. Press and release the UP or DOWN key to select "**Pb1**".
4. Press and release the BLAST CHILLING key: the display will show the cabinet temperature.

Operate as follows to exit the procedure:

5. Press and release the BLAST CHILLING key or do not operate for 15 s: the display will show "**Pb1**" again.
6. Press and release the UP or DOWN key until the display shows the magnitude indicated in paragraph 5.3 "The display" or do not operate for 60 s.

5.5 Display of the temperature detected by the needle probe

Operate as follows:

1. Make sure that the keyboard is not locked and that no procedure is in progress.
2. Hold the DOWN key down for 1 s: the display will show the first label available.
3. Press and release the UP or DOWN key to select "**Pb2**".
4. Press and release the BLAST CHILLING key: the display will show the temperature detected by the needle probe.

Operate as follows to exit the procedure:

5. Press and release the BLAST CHILLING key or do not operate for 15 s: the display will show "**Pb2**" again.
6. Press and release the UP or DOWN key until the display shows the magnitude indicated in paragraph 5.3 "The display" or do not operate for 60 s.

If the needle probe is not enabled, i.e. if parameter P3 is set at 0, the "**Pb2**" label will not be displayed.

5.6 Evaporator temperature display

Operate as follows:

1. Make sure that the keyboard is not locked and that no procedure is in progress.
2. Hold the DOWN key down for 1 s: the display will show the first label available.
3. Press and release the UP or DOWN key to select "**Pb3**".
4. Press and release the BLAST CHILLING key: the display will show the evaporator temperature.

Operate as follows to exit the procedure:

5. Press and release the BLAST CHILLING key or do not operate for 15 s: the display will show "**Pb3**" again.
6. Press and release the UP or DOWN key until the display shows the magnitude indicated in paragraph 5.3 "The display" or do not operate for 60 s.

If the evaporator probe is not enabled, i.e. if parameter P4 is set at 0, the "**Pb3**" label will not be displayed.

5.7 Defrosting activation in manual mode

Operate as follows:

1. Make sure the device is in the "on" status or a storage is in progress.
2. Make sure that the keyboard is not locked and that no procedure is in progress.
3. Hold the UP key down for 4 s: the  LED will switch on.

If the evaporator probe is enabled, i.e. the parameter P4 is set at 1 and on activation of defrosting the evaporator temperature is above that established with parameter d2, defrosting will not be activated.

5.8 Switch-on/off of the cabinet light in manual mode

Operate as follows:

1. Make sure that parameter u11 is set at 0.
2. Make sure no procedures are in progress
3. Press and release the DEEP FREEZING key for 1 sec.: the **AUX** LED will switch on/off.

5.9 Locking/unlocking the keyboard

Operate as follows to lock the keyboard:

1. Make sure no procedures are in progress
2. Hold the DOWN key and the START/STOP key down for 1 s: the display will show "**Loc**" for 1 s.

The following operations will not be allowed if the keyboard is locked:

- switching the device on/off
- cabinet temperature display (with the procedure given in paragraph 5.4)
- display of the temperature detected by the needle probe (with the procedure given in paragraph 5.5)
- evaporator temperature display
- defrosting activation in manual mode
- operating cycle start-up/cut-off
- switching on UV light for sterilisation cycle
- heating the needle probe
- display of information relative to the HACCP alarms
- deleting the information relative to the HACCP alarms
- display of compressor operating hours
- deleting the compressor operating hours
- setting the real date and time.

Operate as follows to unlock the keyboard:

1. Make sure no procedures are in progress
2. Hold the DOWN key and the START/STOP key down for 1 s: the display will show "**UnL**" for 1 s.

5.10 Silencing the buzzer

Operate as follows:

1. Make sure no procedures are in progress
2. Press and release the key.

6 OPERATION

6.1 Foreword

The devices can manage the following operating cycles:

- blast chilling and storage
- hard blast chilling and storage
- deep freezing and storage
- soft deep freezing and storage.

For further information, see the next paragraphs

Every operating cycle can be preceded by pre-cooling; see paragraph 6.6 "Pre-cooling".

The temperature-controlled cycles are preceded by a test to verify the correct insertion of the needle probe; see paragraph 6.7 " Test for verification of the correct insertion of the needle probe"; the time-controlled cycles are not preceded by any test.

If the needle probe is not enabled, i.e. if parameter P3 is set at 0, the temperature-controlled cycles will be started with time-control.

The following functions can also be used:

- switching on sterilisation cycle UV light
- heating the needle probe.

For further information, see the next paragraphs

6.2 Blast chilling and storage

The temperature-controlled blast chilling and storage cycle is divided into the following two phases:

- blast chilling
- storage

On conclusion of a phase, the device passes automatically to the next.

Operate as indicated to start the cycle:

1. Make sure the device is in the "on" status.
2. Make sure that the keyboard is not locked and that no procedure is in progress.
3. Press and release the BLAST CHILLING key: the ❄️ LED and the ↻ LED will flash.
If parameter r21 has value 1, press and release the BLAST CHILLING key to start the cycle with timed-control: the ❄️ LED and the ⌚ LED will flash and the ↻ LED will switch off (press and release the BLAST CHILLING key again to start the cycle with temperature-control).
- 4.1 If parameter r19 is set at 0, the display will show the work set-point during blast chilling; this value can also be set via parameter r7.
If parameter r21 has value 1 and it has been decided to start the cycle with timed-control, the display will show the duration of time-controlled blast chilling; this value can also be set via parameter r1.
- 4.2 If parameter r19 is set at 1, the display will show the blast chilling end temperature; this value can also be set via parameter r3.
If parameter r21 has value 1 and it has been decided to start the cycle with timed-control, the display will show the duration of time-controlled blast chilling; this value can also be set via parameter r1.
- 4.3 Press and release the UP or DOWN key within 15 s to modify the parameter value.
5. Press and release the START/STOP key: the ❄️ LED will remain permanently on and the test to verify the correct insertion of the needle probe will be started; see paragraph 6.7 " Test for verification of the correct insertion of the needle probe".
If parameter r21 has value 1 and it has been decided to start the cycle with timed-control, also the ⌚ will remain permanently on and the cycle will be started with timed-control.
- 5.1 If the test is completed successfully, the cycle will be started.

The maximum blast chilling duration count is started on condition that the temperature detected by the needle probe is below that established with parameter r15.

- 5.2 If the test is not completed successfully, the cycle will be started with timed-control.

During blast chilling, the display shows the residual time of the blast chilling duration and the ☺ LED is on.

To modify the residual time, operate as indicated:

5.2.1 Press and release the UP or DOWN key again to modify the time value: the display will flash.

5.2.2 Do not operate for 4 s: the display will stop flashing and remain on permanently.

The successive parameters establish the following values:

- parameter r1 establishes blast chilling duration
- parameter r7 establishes the work set-point during blast chilling.

Operate as indicated to stop the cycle:

6. Hold the START/STOP key down.

During blast chilling, the display shows the temperature detected by the needle probe and the 🔌 LED is on.

The successive parameters establish the following values:

- parameter r3 establishes the blast chilling end temperature
- parameter r5 establishes the maximum blast chilling duration
- parameter r7 establishes the work set-point during blast chilling.

To display the cabinet temperature, press and release the BLAST CHILLING, DEEP FREEZING or the HARD/SOFT key; to restore the normal display, press and release the same key again or do not operate for 15 s.

If the temperature detected by the needle probe reaches the blast chilling end temperature within the maximum blast chilling duration, it means that blast chilling has been completed successfully, the device will automatically pass to storage and the buzzer will be activated for the period of time established with parameter AA.

Press and release a key to silence the buzzer.

During storage, the display shows the temperature detected by the cabinet and the ⚡ LED is on.

Parameter r10 establishes the work set-point during storage.

If the temperature detected by the needle probe does not reach the blast chilling end temperature within the maximum blast chilling duration, blast chilling will not be completed successfully but will continue, the 🔌 LED will flash and the buzzer will be activated.

Press and release a key to restore normal display and to silence the buzzer.

To display the cabinet temperature, press and release the BLAST CHILLING key; to restore the normal display, press and release the BLAST CHILLING key again or do not operate for 15 s.

When the temperature detected by the needle probe reaches the blast chilling end temperature, the device automatically passes to storage in the same way as illustrated previously.

6.3 Hard blast chilling and storage

The temperature-controlled hard blast chilling and storage cycle is divided into the following three phases:







- blast chilling hard phase
- blast chilling
- storage

On conclusion of a phase, the device passes automatically to the next.

Operate as indicated to start the cycle:

1. Make sure the device is in the "on" status.
2. Make sure that the keyboard is not locked and that no procedure is in progress.
3. Press and release the BLAST CHILLING key: the ❄️ LED and the 🔌 LED will flash.

If parameter r21 has value 1, press and release the BLAST CHILLING key to start the cycle with timed-control: the ❄️ LED and the ☺ LED will flash and the 🔌 LED will switch off (press and release the BLAST CHILLING key again to start the cycle with temperature-control).

4. Press and release the HARD/SOFT key: the HARD LED will flash.
- 5.1 If parameter r19 is set at 0, the display will show the work set-point during blast chilling; this value can also be set via parameter r7.
If parameter r21 has value 1 and it has been decided to start the cycle with timed-control, the display will show the duration of time-controlled blast chilling; this value can also be set via parameter r1.
- 5.2 If parameter r19 is set at 1, the display will show the blast chilling end temperature; this value can also be set via parameter r3.
If parameter r21 has value 1 and it has been decided to start the cycle with timed-control, the display will show the duration of time-controlled blast chilling; this value can also be set via parameter r1.
- 5.3 Press and release the UP or DOWN key within 15 s to modify the parameter value:
6. Press and release the START/STOP key: the  LED and the HARD LED will remain permanently on and the test to verify the correct insertion of the needle probe will be started; see paragraph 6.7 " Test for verification of the correct insertion of the needle probe".
If parameter r21 has value 1 and it has been decided to start the cycle with timed-control, also the  will remain permanently on and the cycle will be started with timed-control.
- 6.1 If the test is completed successfully, the cycle will be started.
The maximum blast chilling duration count is started on condition that the temperature detected by the needle probe is below that established with parameter r15.
- 6.2 If the test is not completed successfully, the cycle will be started with timed-control.
During the hard blast chilling phase, the display shows the residual time of the blast chilling duration and the  LED is on.
To modify the residual time, operate as indicated:
- 6.2.1 Press and release the UP or DOWN key again to modify the time value: the display will flash.
- 6.2.2 Do not operate for 4 s: the display will stop flashing and remain on permanently.
The successive parameters establish the following values:
- parameter r9 establishes the work set-point during the hard blast chilling phase
 - parameter r14 establishes hard blast chilling phase duration.
- During blast chilling, the display shows the residual time of the blast chilling duration and the  LED is on.
The successive parameters establish the following values:
- parameter r1 establishes blast chilling duration
 - parameter r7 establishes the work set-point during blast chilling.
- Operate as indicated to stop the cycle:
7. Hold the START/STOP key down.
During hard blast chilling, the display shows the temperature detected by the needle probe and the  LED is on.
The successive parameters establish the following values:
- parameter r5 establishes the maximum blast chilling duration
 - parameter r9 establishes the work set-point during the blast chilling hard phase
 - parameter r13 establishes blast chilling hard phase end temperature.
- To display the cabinet temperature, press and release the BLAST CHILLING, DEEP FREEZING or the HARD/SOFT key; to restore the normal display, press and release the same key again or do not operate for 15 s.
When the temperature detected by the needle probe reaches the hard blast chilling phase end temperature, the device automatically passes to blast chilling mode.
During blast chilling, the display shows the temperature detected by the needle probe and the  LED is on.
The successive parameters establish the following values:
- parameter r3 establishes the blast chilling end temperature
 - parameter r5 establishes the maximum blast chilling duration
 - parameter r7 establishes the work set-point during blast chilling.

To display the cabinet temperature, press and release the BLAST CHILLING key; to restore the normal display, press and release the BLAST CHILLING key again or do not operate for 15 s.

If the temperature detected by the needle probe reaches the blast chilling end temperature within the maximum blast chilling duration, it means that blast chilling has been completed successfully, the device will automatically pass to storage and the buzzer will be activated for the period of time established with parameter AA.

Press and release a key to silence the buzzer.

During storage, the display shows the temperature detected by the cabinet and the  LED is on.

Parameter r10 establishes the work set-point during storage.

If the temperature detected by the needle probe does not reach the blast chilling end temperature within the maximum blast chilling duration, blast chilling will not be completed successfully but will continue, the  LED will flash and the buzzer will be activated.

Press and release a key to restore normal display and to silence the buzzer.

To display the cabinet temperature, press and release the BLAST CHILLING key; to restore the normal display, press and release the BLAST CHILLING key again or do not operate for 15 s.

When the temperature detected by the needle probe reaches the blast chilling end temperature, the device automatically passes to storage in the same way as illustrated previously.



6.4 Deep freezing and storage





The temperature-controlled deep freezing and storage cycle is divided into the following two phases:

- deep freezing
- storage

On conclusion of a phase, the device passes automatically to the next.

Operate as indicated to start the cycle:

1. Make sure the device is in the "on" status.
2. Make sure that the keyboard is not locked and that no procedure is in progress.
3. Press and release the DEEP FREEZING key: the  LED, the  LED, the HARD LED and the  LED will flash.



*If parameter r21 has value 1, press and release the DEEP FREEZING key to start the cycle with timed-control: the  LED, the  LED, the **HARD** LED and the  LED will flash and the  LED will switch off (press and release the DEEP FREEZING key again to start the cycle with temperature-control).*

- 4.1 If parameter r19 is set at 0, the display will show the work set-point during deep freezing; this value can also be set via parameter r8.

If parameter r21 has value 1 and it has been decided to start the cycle with timed-control, the display will show the duration of time-controlled deep freezing; this value can also be set via parameter r2.

- 4.2 If parameter r19 is set at 1, the display will show the deep freezing end temperature; this value can also be set via parameter r4.

If parameter r21 has value 1 and it has been decided to start the cycle with timed-control, the display will show the duration of time-controlled deep freezing; this value can also be set via parameter r2.

- 4.3 Press and release the UP or DOWN key within 15 s to modify the parameter value:
5. Press and release the START/STOP key: the  LED, the  LED and the HARD LED will remain permanently on and the test to verify the correct insertion of the needle probe will be started; see paragraph 6.7 " Test for verification of the correct insertion of the needle probe".

If parameter r21 has value 1 and it has been decided to start the cycle with timed-control, also the  will remain permanently on and the cycle will be started with timed-control.

- 5.1 If the test is completed successfully, the cycle will be started.

The maximum deep freezing duration count is started on condition that the temperature detected by the needle probe is below that established with parameter r15.

- 5.2 If the test is not completed successfully, the cycle will be started with timed-control.

During deep freezing, the display shows the residual time of the deep freezing duration and the ☺ LED is on.

To modify the residual time, operate as indicated:

5.2.1 Press and release the UP or DOWN key again to modify the time value: the display will flash.

5.2.2 Do not operate for 4 s: the display will stop flashing and remain on permanently.

The successive parameters establish the following values:

- parameter r2 establishes deep freezing duration
- parameter r8 establishes the work set-point during deep freezing.

Operate as indicated to stop the cycle:

6. Hold the START/STOP key down.

During deep freezing, the display shows the temperature detected by the needle probe and the 🔧 LED is on.

The successive parameters establish the following values:

- parameter r4 establishes the deep freezing end temperature
- parameter r6 establishes the maximum deep freezing duration
- parameter r8 establishes the work set-point during deep freezing.

To display the cabinet temperature, press and release the BLAST CHILLING, DEEP FREEZING or the HARD/SOFT key; to restore the normal display, press and release the same key again or do not operate for 15 s.

If the temperature detected by the needle probe reaches the deep freezing end temperature within the maximum deep freezing duration, it means that deep freezing has been completed successfully, the device will automatically pass to storage and the buzzer will be activated for the period of time established with parameter AA.

Press and release a key to silence the buzzer.

During storage, the display shows the temperature detected by the cabinet and the † LED is on.

Parameter r11 establishes the work set-point during storage.

If the temperature detected by the needle probe does not reach the deep freezing end temperature within the maximum deep freezing duration, deep freezing will not be completed successfully but will continue, the 🔧 LED will flash and the buzzer will be activated.

Press and release a key to restore normal display and to silence the buzzer.

To display the cabinet temperature, press and release the DEEP FREEZING key; to restore the normal display, press and release the DEEP FREEZING key again or do not operate for 15 s.

When the temperature detected by the needle probe reaches the deep freezing end temperature, the device automatically passes to storage in the same way as illustrated previously.

6.5 Soft deep freezing and storage

The temperature-controlled soft deep freezing and storage cycle is divided into the following three phases:

- deep freezing soft phase
- deep freezing
- storage

On conclusion of a phase, the device passes automatically to the next.

Operate as indicated to start the cycle:

1. Make sure the device is in the "on" status.
2. Make sure that the keyboard is not locked and that no procedure is in progress.
3. Press and release the DEEP FREEZING key: the ❄️ LED, the ❄️❄️ LED, the HARD LED and the 🔧 LED will flash.

*If parameter r21 has value 1, press and release the DEEP FREEZING key to start the cycle with timed-control: the ❄️ LED, the ❄️❄️ LED, the **HARD** LED and the ☺ LED will flash and the 🔧 LED will switch off (press and release the DEEP FREEZING key again to start the cycle with temperature-control).*

4. Press and release the HARD/SOFT key: the HARD LED will switch off.



- 5.1 If parameter r19 is set at 0, the display will show the work set-point during deep freezing; this value can also be set via parameter r8.

If parameter r21 has value 1 and it has been decided to start the cycle with timed-control, the display will show the duration of time-controlled deep freezing; this value can also be set via parameter r2.

- 5.2 If parameter r19 is set at 1, the display will show the deep freezing end temperature; this value can also be set via parameter r4.

If parameter r21 has value 1 and it has been decided to start the cycle with timed-control, the display will show the duration of time-controlled deep freezing; this value can also be set via parameter r2.

- 5.3 Press and release the UP or DOWN key within 15 s to modify the parameter value:

6. Press and release the START/STOP key: the  LED and the  LED will remain permanently on and the test to verify the correct insertion of the needle probe will be started; see paragraph 6.7 " Test for verification of the correct insertion of the needle probe".

If parameter r21 has value 1 and it has been decided to start the cycle with timed-control, also the  will remain permanently on and the cycle will be started with timed-control.

- 6.1 If the test is completed successfully, the cycle will be started.

The maximum deep freezing duration count is started on condition that the temperature detected by the needle probe is below that established with parameter r15.

- 6.2 If the test is not completed successfully, the cycle will be started with timed-control.

During soft deep freezing, the display shows the residual time of the deep freezing duration and the  LED is on.

To modify the residual time, operate as indicated:

- 6.2.1 Press and release the UP or DOWN key again to modify the time value: the display will flash.

- 6.2.2 Do not operate for 4 s: the display will stop flashing and remain on permanently.

The successive parameters establish the following values:

- parameter r8 establishes the work set-point during deep freezing
- parameter r14 establishes soft deep freezing phase duration.

During deep freezing, the display shows the residual time of the deep freezing duration and the  LED is on.

The successive parameters establish the following values:

- parameter r2 establishes deep freezing duration
- parameter r8 establishes the work set-point during deep freezing.

Operate as indicated to stop the cycle:

7. Hold the START/STOP key down.

During soft deep freezing, the display shows the temperature detected by the needle probe and the  LED is on.

The successive parameters establish the following values:

- parameter r3 establishes deep freezing soft phase end temperature.
- parameter r6 establishes the maximum deep freezing duration
- parameter r7 establishes the work set-point during the deep freezing soft phase.

To display the cabinet temperature, press and release the BLAST CHILLING, DEEP FREEZING or the HARD/SOFT key; to restore the normal display, press and release the same key again or do not operate for 15 s.

When the temperature detected by the needle probe reaches the end temperature of the soft phase, the device automatically passes to deep freezing.

During deep freezing, the display shows the temperature detected by the needle probe and the  LED is on.

The successive parameters establish the following values:

- parameter r4 establishes the deep freezing end temperature
- parameter r6 establishes the maximum deep freezing duration
- parameter r8 establishes the work set-point during deep freezing

To display the cabinet temperature, press and release the DEEP FREEZING key; to restore the normal display, press and release the DEEP FREEZING key again or do not operate for 15 s.

If the temperature detected by the needle probe reaches the deep freezing end temperature within the maximum deep freezing duration, it means that deep freezing has been completed successfully, the device will automatically pass to storage and the buzzer will be activated for the period of time established with parameter AA.

Press and release a key to silence the buzzer.

During storage, the display shows the temperature detected by the cabinet and the  LED is on.

Parameter r11 establishes the work set-point during storage.

If the temperature detected by the needle probe does not reach the deep freezing end temperature within the maximum deep freezing duration, deep freezing will not be completed successfully but will continue, the  LED will flash and the buzzer will be activated.

Press and release a key to restore normal display and to silence the buzzer.

To display the cabinet temperature, press and release the DEEP FREEZING key; to restore the normal display, press and release the DEEP FREEZING key again or do not operate for 15 s.

When the temperature detected by the needle probe reaches the deep freezing end temperature, the device automatically passes to storage in the same way as illustrated previously.

6.6 Pre-cooling start-up

Every operating cycle can be preceded by pre-cooling.

If parameter r22 has value 0, it will be allowed to start pre-cooling by hand; if parameter r22 has value 1, it will be allowed to start pre-cooling both automatically and by hand.

To start pre-cooling automatically, pass from the "stand-by" status to the "on" status (or switch on the device).

Operate as indicated to start pre-cooling by hand:

1. Make sure the device is in the "on" status.
2. Make sure no procedures are in progress
3. Hold the BLAST CHILLING key down for 1 s: the  LED will flash.

Operate as indicated to cut-off pre-cooling:

4. Hold the BLAST CHILLING key for 1 s or start an operating cycle.

Parameter r120 establishes the work set-point during pre-cooling.

When the cabinet temperature reaches that established with parameter r12, pre-cooling continues, the  LED remains on permanently and the buzzer is activated for 1 s.

6.7 Management of the test regarding correct insertion of the needle probe

If the needle probe is enabled, i.e. the parameter P3 is set at 1, the temperature-controlled cycles are preceded by a test on two phases for the verification of the correct insertion of the needle probe.

The second phase is only performed if the first is not completed successfully.

The first phase is completed successfully if the "temperature detected by the needle probe - cabinet temperature" difference is greater than the value established with parameter r17 in at least 3 controls out of 5 (the controls are performed at 10 s intervals, consider the difference without sign).

The second phase is completed successfully if the "temperature detected by the needle probe - cabinet temperature" difference is 1°C/1°F higher with respect to the previous control in at least 6 controls out of 8 (the controls are performed at time intervals corresponding to 1/8 of the time established with parameter r18; consider the difference without sign).

If the test is completed successfully, the cycle will be started; if the test is not completed successfully, the  LED will flash and the buzzer will be activated the time set with parameter r23.

To start the temperature-controlled cycle, press the BLAST CHILLING key or the DEEP FREEZING key. After 1 min from the signal that the test has not been completed successfully without having operated, the cycle is started with time control.

If parameter r17 is set at 0.0, the test will not be carried out (neither first nor second phase).

6.8 Switching on UV light for sterilisation cycle

Operate as follows:

1. Make sure that parameter u11 is set at 2.
2. Make sure the device is in the "on" status and that the door is closed, i.e. the door micro switch is not active.
3. Make sure that the keyboard is not locked and that no procedure is in progress.
4. Hold the DEEP FREEZING key down for 1 s: the **AUX** LED will switch on.

The UV light is switched on for the time period established by parameter u6; opening the door i.e. the activation of the door micro switch cause the light to switch off.

6.9 Heating the needle probe

Operate as follows:

1. Make sure that parameter u11 is set at 1.
2. Make sure the device is in the "on" status or storage is in progress and that the door is open, i.e. the door micro switch is active.
3. Make sure that the keyboard is not locked and that no procedure is in progress.
4. Hold the DEEP FREEZING key down for 1 s: the  LED flashes and the **AUX** LED will switch on.

Output K5 is activated at maximum for the time established with parameter u6 or until the temperature detected by the needle probe reaches that established with parameter u7; closing the door, i.e. the deactivation of the door micro switch input causes heating to be cut-off.

The buzzer is activated for 1 s on conclusion of heating.

7 "HACCP" FUNCTION

7.1 Foreword

Using the "HACCP" function, it is possible to memorise up to 9 events for each of the 3 HACCP alarms, after which the most recent event overwrites the oldest.

The following table illustrates the information relative to the HACCP alarms, which the device can memorise.

Alarm	Code	Critical value	Date and time of occurrence	Duration
temperature-controlled blast chilling or deep freezing not concluded within maximum duration alarm	tiME	the maximum temperature detected by the needle probe after temperature-controlled blast chilling of deep freezing not concluded within maximum duration	yes	from 1 min to 99 h and 59 min, partial if the alarm is in progress
maximum temperature during storage alarm	AH	maximum cabinet temperature during the alarm	yes	from 1 min to 99 h and 59 min, partial if the alarm is in progress
power-cut during storage alarm	PF	the cabinet temperature at restore f power supply	yes	from 1 min to 99 h and 59 min

To prevent repeated memorisation of power cut alarms ("**PF**" code), make sure that the device is in the "stand-by" or "on" status before disconnecting the power supply.

If the duration of the power cut alarm ("**PF**" code) is such to cause a clock error ("**rtc**" code), the device does not memorise the date or time the alarm occurred or its duration.

The **HACCP** LED supplies information relative to the memory status of the HACCP alarms of the device; see paragraph 10.1 "Signals".

7.2 Display of information relative to the HACCP alarms

Operate as follows:

1. Make sure that the keyboard is not locked and that no procedure is in progress.
2. Hold the DOWN key down for 1 s: the display will show the first label available.
3. Press and release the UP or DOWN key to select "**LS**".
4. Press and release the BLAST CHILLING key: the display will show the most recent alarm code, i.e. one of the codes stated in the table in paragraph 7.1 "Foreword", followed by the number "**1**" (the higher the number that follows the alarm code, the older the alarm).

To display the information relative to a HACCP alarm, operate as follows:

5. Press and release the UP or DOWN key to select an alarm code, for example "**AH3**".
6. Press and release the BLAST CHILLING key: the **HACCP** LED will stop flashing and remain on permanently and the display will show, for example, the following information in succession:

Inf.	Meaning
8.0	the critical value is 8.0 °C/8 °F
StA	the display is about to show the date and time the alarm occurred
y11	the alarm occurred in 2011 (continue...)
n03	the alarm occurred in the month of March (continue...)
d26	the alarm occurred on 26 March 2011
h16	the alarm occurred at 16:00 (continue...)
n30	the alarm occurred at 16:30
dur	the display is about to show the duration of the alarm
h01	the alarm had duration of 1 h (continue ...)
n15	the alarm had duration of 1 h and 15 minutes
AH3	the alarm code selected

the displays each piece of information for 1 s.

Operate as follows to abandon the succession of information:

7. Press and release the START/STOP key: the display will show the alarm code selected again.

Operate as follows to exit the procedure:

8. Abandon the succession of information.
9. Press and release the UP or DOWN key until the display shows the magnitude indicated in paragraph 5.3 "The display" or do not operate for 60 s.

7.3 Deleting the information relative to the HACCP alarms

Operate as follows:

1. Make sure that the keyboard is not locked and that no procedure is in progress.
2. Hold the DOWN key down for 1 s: the display will show the first label available.
3. Press and release the UP or DOWN key to select "rLS".
4. Press and release the BLAST CHILLING key: the display will show "0"
5. Press and release the UP or DOWN key within 15 s to set "149".
6. Press and release the BLAST CHILLING key or do not operate for 15 s: the display will show "- - -" flashing for 4 s and the **HACCP** LED will switch off, after which the device will automatically exit the procedure and the display will show the magnitude indicated in paragraph 5.3 "The display".

If the device has not memorised any information relative to the HACCP alarms, the "rLS" label will not be displayed.

8 COMPRESSOR OPERATING HOURS COUNT

8.1 Display of compressor operating hours

Operate as follows:

1. Make sure that the keyboard is not locked and that no procedure is in progress.
2. Hold the DOWN key down for 1 s: the display will show the first label available.
3. Press and release the UP or DOWN key to select "**CH**".
4. Press and release the BLAST CHILLING key: the display will show the compressor operating hours.

Operate as follows to exit the procedure:

5. Press and release the BLAST CHILLING key or do not operate for 15 s: the display will show "**Pb2**" again.
6. Press and release the UP or DOWN key until the display shows the magnitude indicated in paragraph 5.3 "The display" or do not operate for 60 s.

8.2 Deleting the compressor operating hours

Operate as follows:

1. Make sure that the keyboard is not locked and that no procedure is in progress.
2. Hold the DOWN key down for 1 s: the display will show the first label available.
3. Press and release the UP or DOWN key to select "**rCH**".
4. Press and release the BLAST CHILLING key: the display will show "**0**".
5. Press and release the UP or DOWN key within 15 s to set "**149**".
6. Press and release the BLAST CHILLING key or do not operate for 15 s: the display will show "- - -" flashing for 4 s and the **HACCP** LED will switch off, after which the device will automatically exit the procedure and the display will show the magnitude indicated in paragraph 5.3 "The display".

9 CONFIGURATION

9.1 Setting the real date and time

Operate as follows:

1. Make sure that the keyboard is not locked and that no procedure is in progress.
2. Hold the DOWN key down for 1 s: the display will show the first label available.
3. Press and release the UP or DOWN key to select "**rtc**".

Operate as follows to set the year:

4. Press and release the BLAST CHILLING key: the display will show "**yy**" followed by the last two numbers of the year and the ☺ LED will flash.
5. Press and release the UP or DOWN key within 15 s to modify the value:

Operate as follows to set the month:

6. Press and release the BLAST CHILLING key when setting the year: the display will show "**nn**" followed by the two numbers of the month.
7. Press and release the UP or DOWN key within 15 s to modify the value:

Operate as follows to set the day of the month:

8. Press and release the BLAST CHILLING key when setting the month: the display will show "**dd**" followed by the two numbers of the month.
9. Press and release the UP or DOWN key within 15 s to modify the value:

Operate as follows to set the hour:

10. Press and release the BLAST CHILLING key when setting the day of the month: the display will show "**hh**" followed by the two numbers of the hour.
11. Press and release the UP or DOWN key within 15 s to modify the value:

The hour is displayed in the 24 h format.

Operate as follows to set the minutes:

12. Press and release the BLAST CHILLING key when setting the hour: the display will show "**nn**" followed by the two numbers of the minutes.
13. Press and release the UP or DOWN key within 15 s to modify the value:
14. Press and release the BLAST CHILLING key or do not operate for 15 s: the display will show "**rtc**" again and the ☺ LED will switch off.

Operate as follows to exit the procedure:

15. Press and release the UP or DOWN key until the display shows the magnitude indicated in paragraph 5.3 "The display" or do not operate for 60 s.

9.2 Setting the configuration parameters

Operate as follows:

1. Make sure no procedures are in progress
2. Hold the UP and DOWN key for 4 s: the display will show "**PA**".
3. Press and release the BLAST CHILLING key: the display will show "**0**".
4. Press and release the UP or DOWN key within 15 s to set "**-19**".
5. Press and release the BLAST CHILLING key or do not operate for 15 s: the display will show "**PA**" again.
6. Hold the UP and DOWN key for 4 s: the display will show "**SP**".

Operate as follows to set a parameter:

7. Press and release the UP or DOWN key to select a parameter label.
8. Press and release the BLAST CHILLING key: the display will show the value of the parameter.
9. Press and release the UP or DOWN key within 15 s to modify the parameter value:

- Press and release the BLAST CHILLING key or do not operate for 15 s: the display will show the parameter label again.

Operate as follows to exit the procedure:

- Hold the UP and DOWN key for 4 s or do not operate for 60 s The display will show the magnitude indicated in paragraph 5.3 "The display".

Cut the device power supply off after setting the configuration parameters.

9.3 Restoring the factory settings

Operate as follows:

- Make sure no procedures are in progress
- Hold the UP and DOWN key for 4 s: the display will show "**PA**".
- Press and release the BLAST CHILLING key: the display will show "**0**".
- Press and release the UP or DOWN key within 15 s to set "**149**".
- Press and release the BLAST CHILLING key or do not operate for 15 s: the display will show "**PA**" again.
- Hold the UP and DOWN key for 4 s: the display will show "**DEF**".
- Press and release the BLAST CHILLING key: the display will show "**0**".
- Press and release the UP or DOWN key within 15 s to set "**1**".
- Press and release the BLAST CHILLING key or do not operate for 15 s: the display will show "**DEF**" flashing for 4 s, after which the device will automatically exit the procedure and the display will show the magnitude indicated in paragraph 5.3 "The display".
- C the device power supply off.

Operate as follows to abandon the procedure:

- Hold the UP and DOWN key for 4 s before point 8: The display will show the magnitude indicated in paragraph 5.3 "The display".

Ensure that the factory settings are appropriate; see paragraph 8.4 "List of configuration parameters".

9.4 List of configuration parameters

The following table illustrates the meaning of the configuration parameters.

The management of some inputs and outputs is subject to the value set with some parameters, as follows:

- management of the needle probe is only available if the parameter P3 is set at 1
- management of the evaporator probe is only available if the parameter P4 is set at 1
- management of the door heating elements is only available if the parameter u1 is set at 0
- management of the condenser fan is only available if the parameter u1 is set at 1
- management of the cabinet light is only available if the parameter u11 is set at 0
- management of needle probe heating is only available if the parameter u11 is set at 1
- management of the UV light is only available if the parameter u11 is set at 2.

Par.	Min.	Max.	Unit	Default	Analogue inputs
CA1	-25.0	25.0	°C/°F (1)	0.0	cabinet probe offset
CA2	-25.0	25.0	°C/°F (1)	0.0	needle probe offset
CA3	-25.0	25.0	°C/°F (1)	0.0	evaporator probe offset

P0	0	1	----	0	probe type 0 = PTC 1 = NTC
P1	0	1	----	1	°C decimal point 1 = yes
P2	0	1	----	0	temperature unit of measurement (2) 0 = °C 1 = °F
P3	0	1	----	1	enabling the needle probe 1 = yes
P4	0	1	----	1	enabling the evaporator probe 1 = yes
P8	0	250	ds	5	delay displaying temperature variation detected by the probes
P9	0	2	----	1	type of backlight 0 = off during "on" status and during the "run" status and with START/STOP key low light intensity during the "stand-by" status 1 = with low light intensity during the "on" status and during the "run" status and with START/STOP key low light intensity during the "stand-by" status 2 = with high light intensity during the "on" status and during the "run" status and with START/STOP key high light intensity during the "stand-by" status
Par.	Min.	Max.	Unit	Default	Main regulator
r0	0.1	15.0	°C/°F (1)	2.0	parameters differential r7, r8, r9, r10, r11 and r12
r1	1	500	min	90	duration of time-controlled blast chilling
r2	1	500	min	240	duration of time-controlled deep freezing
r3	-50.0	99.0	°C/°F (1)	3.0	temperature-controlled blast chilling end time temperature; also end temperature of the temperature-controlled soft deep freezing phase (temperature detected by the needle probe); see also parameter r5
r4	-50.0	99.0	°C/°F (1)	-18.0	temperature-controlled deep freezing end temperature (temperature detected by the needle probe); see also parameter r6

r5	1	500	min	90	maximum duration of temperature-controlled blast chilling; see parameter r3 also
r6	1	500	min	240	maximum duration of temperature-controlled deep freezing; see parameter r4 also
r7	-50.0	99.0	°C/°F (1)	0.0	work set-point during blast chilling; also work set-point during the soft deep freezing phase (cabinet temperature); see also parameter r0
r8	-50.0	99.0	°C/°F (1)	-40.0	work set-point during deep freezing (cabinet temperature); see also parameter r0
r9	-50.0	99.0	°C/°F (1)	-20.0	work set-point during hard blast chilling phase (cabinet temperature); see also parameter r0
r10	-50.0	99.0	°C/°F (1)	2.0	work set-point during post blast chilling storage (cabinet temperature); see also parameter r0
r11	-50.0	99.0	°C/°F (1)	-20.0	work set-point during post deep freezing storage (cabinet temperature); see also parameter r0
r12	-50.0	99.0	°C/°F (1)	5.0	work set-point during pre-cooling (cabinet temperature); see also parameter r0
r13	-50.0	99.0	°C/°F (1)	15.0	end temperature of the temperature-controlled hard blast chilling phase (temperature detected by the needle probe)
r14	10	100	%	60	duration of the time-controlled hard blast chilling phase (intended as a percentage of the value established with parameter r1); also duration of the time-controlled soft deep freezing phase (intended as a percentage of the value established with parameter r2)
r15	-50.0	99.0	°C/°F (1)	65.0	temperature below which the count of the maximum temperature-controlled blast chilling and maximum temperature-controlled deep freezing is started (temperature detected by the needle probe)
r16	0	2	----	1	type of operating cycle that can be selected 0 = blast chilling and storage 1 = blast chilling and storage or deep freezing and storage 2 = deep freezing and storage

r17	0.0	99.0	°C/°F (1)	5.0	"temperature detected by the needle probe - cabinet temperature" minimum difference such to consider the first phase of the test to verify correct insertion of the needle probe completed successfully (consider the difference without sign) 0.0 = the test will not be performed (neither first or second phase)
r18	1	99	s	60	duration of the second phase of the test for verification of correct insertion of the needle probe
r19	0	1	----	0	quick modification value during the "On" status before starting the operating cycle 0 = work set-point during blast chilling or during deep freezing 1 = blast chilling or deep freezing end temperature
r20	0	1	----	1	memorisation of the quick modification value during the "On" status before starting the operating cycle 0 = no (on start-up of the successive same cycle, the values established with parameters r7 and r3 or those establishes with r4 and r8 will be re-proposed) 1 = yes (on start-up of the successive same cycle the rapidly modified values will be re-proposed before starting the previous same cycle)
r21	0	1	----	1	modality the operating cycle is started time controller rather than time controlled 0 = automatic (or through the test regarding correct insertion of the needle probe) 1 = by hand (or pressing and releasing the BLAST CHILLING or DEEP FREEZING key)
r22	0	1	----	0	modality to start pre-cooling 0 = manual (or pressing the BLAST CHILLING key 1 s) 1 = both automatic (or passing from the "stand-by" status to the "on", then switching on the device) and by hand (or pressing the BLAST CHILLING key 1 s)
r23	0	50	s	2	duration of the buzzer activation to signal the verification test for the correct insertion of the needle probe will not have been completed successfully
Par.	Min.	Max.	Unit	Default	Compressor protections

C0	0	240	min	0	minimum time between restoring the power supply after a power cut, occurring during an operating cycle and compressor switch-on
C1	0	240	min	5	minimum time between two consecutive compressor switch-ons (3)
C2	0	240	min	3	minimum time between compressor switch-off and successive switch-on (3)
C3	0	240	s	0	compressor switch-on minimum duration
C4	0	240	min	10	duration of compressor switch-off during the cabinet probe error ("Pr1" code) that occurs during storage; see also parameter C5
C5	0	240	min	10	duration of compressor switch-on during the cabinet probe error ("Pr1" code) that occurs during post blast chilling storage; see also parameter C4
C9	0	240	min	30	duration of compressor switch-on during the cabinet probe error ("Pr1" code) that occurs during post deep freezing storage; see also parameter C4
Par.	Min.	Max.	Unit	Default	Defrosting (5)
d0	0	99	h	8	defrosting interval (6) 0 = defrosting will never be activated at intervals

d1	0	3	----	1	<p>type of defrosting</p> <p>0 = electrical (the compressor will be switched off during defrosting, the defrosting output will be activated and the evaporator fan will be switched off)</p> <p>1 = hot gas (the compressor will be switched on during defrosting, the defrosting output will be activated and the evaporator fan will be switched off)</p> <p>2 = air (the compressor will be switched off during defrosting and the defrosting output will be activated; the evaporator fan will be switched on, independently from the conditions of the door, i.e. independently from the door micro switch input status)</p> <p>3 = air with door open (the compressor will be switched off during defrosting and the defrosting output will be activated; the evaporator fan will be switched on, on condition that the door is open, i.e. that is on condition that the door micro switch is active and that the parameter i0 is set at values different to 0)</p>
d2	-50.0	99.0	°C/°F (1)	2.0	defrosting end temperature (evaporator temperature); see also parameter d3
d3	0	99	min	30	<p>if parameter P4 is set at 0, duration of defrosting</p> <p>if parameter P4 is set at 1, maximum duration of defrosting; see also parameter d2</p> <p>0 = defrosting will never be activated</p>
d4	0	1	----	0	<p>defrosting on start-up of blast chilling and deep freezing</p> <p>1 = yes</p>
d5	0	99	min	30	<p>defrosting delay on start-up of storing</p> <p>0 = defrosting will be started on expiry of the time established with parameter d0</p>
d7	0	15	min	2	dripping duration (the compressor and the evaporator fan remain off during dripping and the defrosting output will be deactivated)
d15	0	99	min	0	minimum duration of compressor switch-on on activation of defrosting so these can be activated (only if parameter d1 is set at 1) (7)

d16	0	99	min	0	duration of pre-dripping (only if parameter d1 is set at 1; the compressor and evaporator fan will be off during pre-dripping and the defrosting output will remain activated)
Par.	Min.	Max.	Unit	Default	Temperature alarms (8) (9)
A1	0.0	99.0	°C/°F (1)	10.0	cabinet temperature below which the minimum temperature alarm is activated (relative to the work set-point, i.e. "r10 - A1" during post blast chilling storage and "r11 - A1" during post deep freezing storage; ("AL" code); see also parameter A11 (4)
A2	0	1	----	1	enabling of minimum temperature alarm ("AL" code) 1 = yes
A4	0.0	99.0	°C/°F (1)	10.0	cabinet temperature above which the maximum temperature alarm is activated (relative to the work set-point, i.e. "r10 +A4" during post blast chilling storage and "r11 +A4" during post deep freezing storage; ("AH" code); see also parameter A11 (4)
A5	0	1	----	1	enabling of maximum temperature alarm ("AH" code) 1 = yes
A7	0	240	min	15	temperature alarm delay("AL" code and "AH" code)
A8	0	240	min	15	maximum temperature alarm delay ("AH" code) from the conclusion of evaporator fan stop and storage start-up
A10	0	240	min	5	duration of a power cut such to cause the power cut alarm to be memorised ("PF" code)when the power is supplied 0 = the alarm will not be signalled
AA	0	240	s	5	duration of buzzer activation on conclusion of blast chilling and deep freezing
A11	0,1	15,0	°C/°F (1)	2,0	parameters A1 and A4 differential

A13	0	1	----	1	memorisation of the temperature-controlled blast chilling or temperature-controlled deep freezing non concluded within maximum duration alarm (" tiME ") 1 = yes
Par.	Min.	Max.	Unit	Default	Evaporator and condenser fan
F0	0	2	----	1	evaporator fan activity during pre-cooling, blast chilling and deep freezing 0 = off 1 = on; see also parameters F16 and F17 2 = parallel to the compressor; see also parameters F9 and F17
F1	-50.0	99.0	°C/°F (1)	-1.0	evaporator temperature above which the evaporator fan is off during storage (only if parameter F2 is set at 3); see also parameter F8(10)
F2	0	3	----	3	evaporator fan activity during storage 0 = off 1 = on 2 = parallel to the compressor; see also parameter F9 3 = on; see also parameter F1
F3	0	15	min	2	duration of evaporator fan standstill (the compressor can be on during evaporator fan standstill, the defrosting output will remain deactivated and the evaporator fan will remain off)
F8	0.1	15.0	°C/°F (1)	2.0	F1, F16 and F17 parameters differential
F9	0	240	s	0	evaporator fan switch-off delay from compressor switch off (only if parameter F0 and/or parameter F2 are set at 2)
F12	0	240	s	30	condenser fan switch-off delay from compressor switch-off (11)
F15	0	240	s	15	evaporator fan delay from door closure, i.e. from the deactivation of the door micro switch input

F16	-50.0	99.0	°C/°F (1)	20.0	evaporator temperature above which the evaporator fan is off during pre-cooling, blast chilling and deep freezing (only if parameter F0 is set at 1); see also parameter F8 (10)
F17	-50.0	99.0	°C/°F (1)	90.0	cabinet temperature above which the evaporator fan is off during pre-cooling, blast chilling and deep freezing (only if parameter F0 is set at 1 or 2); see also parameter F8
Par.	Min.	Max.	Unit	Default	Digital inputs
i0	0	2	- - - -	2	effect caused by opening the door, i.e. by activation of the door micro switch (12) 0 = no effect 1 = the compressor and the evaporator fan will be off and the cabinet light will be on. On expiry of the time established with parameter i2, the display will show the flashing " id " code and the buzzer will be activated (until the door is closed); see also parameter F15 (13) 2 = the evaporator fan will be off and the cabinet light will be on. On expiry of the time established with parameter i2, the display will show the flashing " id " code and the buzzer will be activated (until the door is closed); see also parameter F15
i1	0	1	- - - -	0	type of door micro switch input contact 0 = normally open (input active with closed contact) 1 = normally closed (input active with open contact)
i2	-1	120	min	5	door open alarm signalling delay (" id " code); on expiry of the time established with the parameter, the compressor will be off -1 = the alarm will not be signalled
i5	0	1	- - - -	1	effect caused by the activation of the high pressure input 0 = no effect 1 = the compressor and the evaporator fan will be off and the condenser fan will be on. On expiry of the time established with parameter i7, the display will show the flashing " HP " code and the buzzer will be activated (until the input is deactivated)

i6	0	1	----	0	type of high pressure input 1 0 = normally open (input active with closed contact) 1 = normally closed (input active with open contact)
i7	-1	240	s	5	high pressure alarm signalling delay ("HP" code) -1 = the alarm will not be signalled
Par.	Min.	Max.	Unit	Default	Digital outputs
u1	0	1	----	0	utility managed by the output K4 (14) 0 = door heating elements (in this case, parameter u5 will assume significance) 1 = condenser fan (in this case, parameter u5 will assume significance)
u2	0	1	----	0	enabling of cabinet light switch-on/off in manual mode during "stand-by" status (15) 1 = yes
u5	-50.0	99.0	°C/°F (1)	20.0	cabinet temperature over which the door heating elements are off (4)
u6	1	240	min	5	if parameter u11 is set at 1, maximum duration of needle probe heating; see also parameter u7 if parameter u11 is set at 2, duration of UV light switch-on for the sterilisation cycle
u7	-50.0	99.0	°C/°F (1)	40.0	needle probe heating end temperature (temperature detected by the needle probe); see also parameter u6
u11	0	2	----	0	utility managed by the output K5 (14) 0 = cabinet light (in this case, the DEEP FREEZING key and parameters i0 and u2 will assume significance) 1 = needle probe heating (in this case, the DEEP FREEZING key and parameters u6 and u7 will assume significance) 2 = UV light (in this case, the DEEP FREEZING key and parameter u6 will assume significance)
Par.	Min.	Max.	Unit	Default	Serial communication (MODBUS)
LA	1	247	----	247	device address

Lb	0	3	----	2	baud rate 0 = 2,400 baud 1 = 4,800 baud 2 = 9,600 baud 3 = 19,200 baud
LP	0	2	----	2	Parity 0 = none (no parity) 1 = odd 2 = even
Par.	Min.	Max.	Unit	Default	Reserved
E9	0	1	----	1	Reserved





Notes:



- (1) the unit of measurement depends on parameter P2
- (2) appropriately set the parameters relative to the regulators after modification of parameter P2
- (3) the time established with the parameter is counted also during the "on" status and during the "stand-by" status
- (4) The parameter differential is 2 °C/4 °F
- (5) defrosting is only enabled during storage, except for defrosting on blast chilling start and deep freezing start, which can be established using parameter d4
- (6) the device memorises the defrosting interval count every 30 minutes; the modification of parameter d0 has effect from the conclusion of the previous defrosting interval (or the activation of defrosting in manual mode)
- (7) if on activation of defrosting, the previous compressor switched on at from a time shorter than that established with parameter d15, the compressor will remain on longer for the fraction of time necessary to complete this time period
- (8) the temperature alarms are only enabled during storage
- (9) during defrosting. pre-dripping, dripping and evaporator fan standstill, the temperature alarms are not enabled, on condition that they occurred after activation of defrosting. When the door is open, i.e. if the door micro switch input is active and the parameter i0 is set at values different to 0, the maximum temperature alarm is not enabled, on condition that occurred after the door was opened
- (10) if parameter P4 is set at 0, during pre-cooling, blast chilling and deep freezing the evaporator fan will be on and during storing the device will operate as if parameter F2 it were set at 2
- (11) the condenser fan operates parallel to the compressor
- (12) the door open is enabled only using the "run" state
- (13) if the door is opened during defrosting or evaporator fan standstill, opening has no effect on the compressor
- (14) modify the parameter during the "stand-by" status to prevent damage to the utility
- (15) if parameter u2 is set at 0, device switch-off will cause the cabinet light to switch off and on successive switch on the cabinet light will remain off. If parameter u2 is set at 1, device switch-off will not cause the cabinet light to switch off and on successive switch-on the cabinet light stays on.

10 SIGNALS AND INDICATIONS

10.1 Signals

The following table illustrates the meaning of the signalling LEDs.

LED	Meaning
	<p>Blast chilling LED.</p> <p>If it is on:</p> <ul style="list-style-type: none"> - blast chilling in progress. <p>If flashing:</p> <ul style="list-style-type: none"> - a blast chilling and storage cycle will have been selected.
	<p>Deep freezing LED.</p> <p>If it is on:</p> <ul style="list-style-type: none"> - soft deep freezing will be in progress. <p>If flashing:</p> <ul style="list-style-type: none"> - a soft deep freezing and storage cycle will have been selected.
HARD	<p>hard blast chilling/deep freezing LED</p> <p>If it is on:</p> <ul style="list-style-type: none"> - hard blast chilling or deep freezing will be in progress. <p>If flashing:</p> <ul style="list-style-type: none"> - a hard blast chilling and storage cycle or a deep freezing and storage cycle will have been selected.
	<p>temperature-controlled blast chilling/temperature-controlled deep freezing LED.</p> <p>If it is on:</p> <ul style="list-style-type: none"> - a temperature-controlled blast chilling and storage cycle or a temperature-controlled deep freezing and storage cycle will have been selected. - temperature-controlled blast chilling or deep freezing will be in progress. <p>If flashing:</p> <ul style="list-style-type: none"> - the verification test for the correct insertion of the needle probe will not have been completed successfully - needle probe heating will be in progress.
	<p>time-controlled blast chilling/time-controlled deep freezing LED.</p> <p>If it is on:</p> <ul style="list-style-type: none"> - a time-controlled blast chilling and storage cycle or a time-controlled deep freezing and storage cycle will have been selected. - time-controlled blast chilling or deep freezing will be in progress. <p>If flashing:</p> <ul style="list-style-type: none"> - setting the real date and time will be in progress.
	<p>Storage LED.</p> <p>If it is on:</p> <ul style="list-style-type: none"> - storage will be in progress.

	<p>Defrosting LED.</p> <p>If it is on:</p> <ul style="list-style-type: none"> - defrosting will be in progress.
	<p>Pre-cooling LED.</p> <p>If it is on:</p> <ul style="list-style-type: none"> - pre-cooling will be in progress and the cabinet temperature will have reached that established using parameter r12. <p>If flashing:</p> <ul style="list-style-type: none"> - pre-cooling will be in progress and the cabinet temperature will not have reached that established using parameter r12.
AUX	<p>Auxiliary LED.</p> <p>If it is on:</p> <ul style="list-style-type: none"> - the cabinet light will be on - needle probe heating will be in progress - the UV light will be on
HACCP	<p>HACCP LED.</p> <p>If it is on:</p> <ul style="list-style-type: none"> - all information regarding HACCP alarms will not have been displayed. <p>If flashing:</p> <ul style="list-style-type: none"> - the device will have memorised at least one new HACCP alarm.
°C	<p>Degree Celsius LED.</p> <p>If it is on:</p> <ul style="list-style-type: none"> - the temperature unit of measurement will be the degree Celsius.
°F	<p>Degree Fahrenheit LED.</p> <p>If it is on:</p> <ul style="list-style-type: none"> - the temperature unit of measurement will be the degree Fahrenheit.
min	<p>minutes LED.</p> <p>If it is on:</p> <ul style="list-style-type: none"> - the time unit of measurement will be the minute.
	<p>On/stand-by LED.</p> <p>If it is on:</p> <ul style="list-style-type: none"> - the device will be in the "stand-by" status.

If the START / STOP button flashes, it means an operating cycle is in progress.

10.2 Indications

The following table illustrates the meaning of the indication codes.

Code	Meaning
Loc	The keyboard is locked, see paragraph 5.10 "Lock/unlock the keyboard".
UnL	The keyboard has been locked, see paragraph 5.10 "Lock/unlock the keyboard".

11 ALARMS

11.1 Alarms

The following table illustrates the meaning of the alarm codes.

Code	Meaning
tiME	<p>Temperature-controlled blast chilling or deep freezing not concluded within maximum duration alarm (HACCP alarm).</p> <p>Solutions:</p> <ul style="list-style-type: none"> - check the value of parameters r5 and r6 and AA. <p>Main consequences:</p> <ul style="list-style-type: none"> - the device will memorise the alarm.
AL	<p>Minimum temperature alarm.</p> <p>Solutions:</p> <ul style="list-style-type: none"> - check the temperature of the cabinet - check the value of parameters A1 and A2. <p>Main consequences:</p> <ul style="list-style-type: none"> - the device will continue to operate normally.
AH	<p>Maximum temperature alarm (HACCP alarm).</p> <p>Solutions:</p> <ul style="list-style-type: none"> - check the temperature of the cabinet - check the value of parameters A4 and A5. <p>Main consequences:</p> <ul style="list-style-type: none"> - the device will memorise the alarm.
id	<p>Door open alarm</p> <p>Solutions:</p> <ul style="list-style-type: none"> - check the door conditions - check the value of parameters i0 and i1. <p>Main consequences:</p> <ul style="list-style-type: none"> - the effect established with parameter i0.
HP	<p>High pressure alarm.</p> <p>Solutions:</p> <ul style="list-style-type: none"> - check the conditions of the high pressure input - check the value of parameters i5 and i6. <p>Main consequences:</p> <ul style="list-style-type: none"> - the effect established with parameter i5.
PF	<p>Power supply cut-off alarm (HACCP).</p> <p>Solutions:</p> <ul style="list-style-type: none"> - check the device-power supply connection - check the value of the parameter A10. <p>Main consequences:</p> <ul style="list-style-type: none"> - the device will memorise the alarm.

ESt	<p>Configuration parameters download not completed successfully alarm.</p> <p>Solutions:</p> <ul style="list-style-type: none">- press and release a key to restore normal display- download the configuration parameters again. <p>Main consequences:</p> <ul style="list-style-type: none">- the device will continue to operate normally.
CEr	<p>Configuration parameters firmware contained in EVKEY not coinciding with that of the device.</p> <p>Solutions:</p> <ul style="list-style-type: none">- cut the device power supply off- check that the configuration parameters firmware contain in EVKEY coincides with that of the device- download the configuration parameters again. <p>Main consequences:</p> <ul style="list-style-type: none">- the device will continue to operate normally.
Erd	<p>Configuration parameters upload not completed successfully alarm.</p> <p>Solutions:</p> <ul style="list-style-type: none">- to restore the factory settings- upload the configuration parameters again. <p>Main consequences:</p> <ul style="list-style-type: none">- the digital outputs will be switched off.

12 ERRORS

12.1 Errors

The following table illustrates the meaning of the error codes.

Code	Meaning
Pr1	<p>Cabinet probe error.</p> <p>Solutions:</p> <ul style="list-style-type: none"> - check the value of the parameter P0 - check the integrity of the probe - check the device-probe connection - check the temperature of the cabinet. <p>Main consequences:</p> <ul style="list-style-type: none"> - if the error occurs during the "stand-by" status, no operating cycles can be selected or started - if the error occurs during blast chilling or deep freezing, the cycle will be interrupted - if the error occurs during storage, compressor activity will depend on parameters C4 and C5 or C9 - defrosting will never be activated - the door heating elements will never be switched on - the minimum temperature alarm ("AL" code) will never be activated - the maximum temperature alarm ("AH" code) will never be activated
Pr2	<p>Needle probe error.</p> <p>Solutions:</p> <ul style="list-style-type: none"> - the same as the cabinet probe error ("Pr1" code) but relative to the needle probe. <p>Main consequences:</p> <ul style="list-style-type: none"> - if the error occurs during the "stand-by" status, temperature-controlled operating cycles will be started by time-control - if the error occurs during temperature-controlled blast chilling, this will have duration of the time set by parameter r1 - if the error occurs during temperature-controlled deep freezing, this will have duration of the time set by parameter r2 - if the error occurs during needle probe heating, this operation will be interrupted.
Pr3	<p>Evaporator probe error.</p> <p>Solutions:</p> <ul style="list-style-type: none"> - the same as the cabinet probe error ("Pr1" code) but relative to the evaporator probe. <p>Main consequences:</p> <ul style="list-style-type: none"> - if parameter P4 is set at 1, defrosting will last for the period of time established with parameter d3 - if parameter F0 is set at 1, parameter F16 will have no effect - if parameter F4 is set at 1, the device will operate as if it were set at 2.

rtc	Clock error. Solutions: <ul style="list-style-type: none">- set the real date and time again. Main consequences: <ul style="list-style-type: none">- the device does not memorise the date or time at which the HACCP alarm occurred or its duration.
ErC	User interface-control module compatibility. Solutions: <ul style="list-style-type: none">- check that the user interface and the control module are compatible. Main consequences: <ul style="list-style-type: none">- the control module will continue to operate normally.
ErL	User interface-control module communication error. Solutions: <ul style="list-style-type: none">- check user interface-control module control module. Main consequences: <ul style="list-style-type: none">- the control module will continue to operate normally.

13 ACCESSORIES

13.1 EVKEY programming key

13.1.1 Introduction

EVKEY is a programming key.

The key can be used to upload and download the configuration parameters.

The key can be used on condition that the device is powered.

13.1.2 Description

The following drawing illustrates the aspect of the EVKEY.

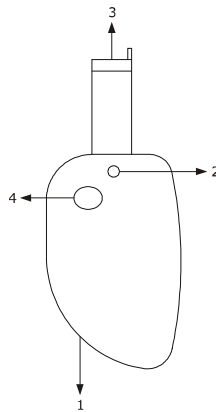

The following table illustrates the meaning of the EVKEY parts.

Part	Meaning
1	reserved
2	Signal LED
3	Micromatch connector
4	programming key

13.1.3 Dimensions

The following drawing illustrates the EVKEY dimensions; these are expressed in mm (in).

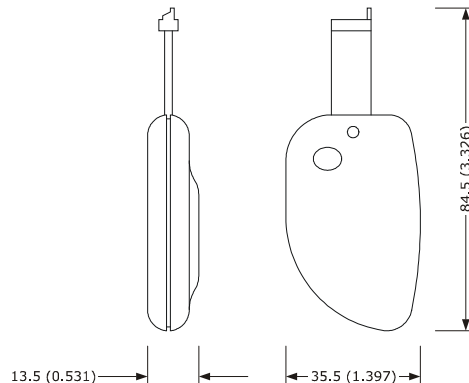

13.1.4 Uploading the configuration parameters

Operate as follows:

1. Cut the device power supply off.
2. Insert the EVKEY Micromatch connector into the device communication port.
3. Connect the device power supply. the display will show "**Cln**" and the EVKEY signal LED will emit a green light.
4. Hold the BLAST CHILLING key down for 4 s: the display will show flashing "**St**"
5. Hold the BLAST CHILLING key down for 4 s: download will start, the display will show "**St**" permanently and the EVKEY signalling LED will emit a red light.

The download operation requires several seconds. If the operation is not completed successfully within this time period, i.e. if the EVKEY signalling LED does not stop emitting red light and emitting green light, the operation must be repeated.

6. When downloading has been concluded, the display restores normal viewing and the EVKEY signalling LED emits green light again.
7. Disconnect the EVKEY Micromatch connector into the device communication port.

Operate as follows to abandon the procedure:

8. Do not operate for 60 s.
9. Disconnect the EVKEY Micromatch connector into the device communication port.

For further information, consult the documentation relative to EVKEY.

13.1.5 Downloading the configuration parameters

Operate as follows:

1. Make sure that the configuration parameters firmware contained in EVKEY coincides with that of the device.
2. Cut the device power supply off.
3. Insert the EVKEY Micromatch connector into the device communication port.
4. Connect the device power supply. the display will show "**Cln**" and the EVKEY signal LED will emit a green light.
5. Hold the EVKEY programming key down for 1 s: upload will start and the EVKEY signalling LED will emit a red light.

The upload operation requires several seconds. If the operation is not completed successfully within this time period, i.e. if the EVKEY signalling LED does not stop emitting red light and emitting green light, the operation must be repeated.

6. The display will show "**PrG**" on conclusion of the upload and the EVKEY signalling LED will emit a green light again.

7. Press and release a key to restore normal display.
8. Disconnect the EVKEY Micromatch connector into the device communication port.

Operate as follows to abandon the procedure:

9. Do not operate for 60 s.
10. Disconnect the EVKEY Micromatch connector into the device communication port.

For further information, consult the documentation relative to EVKEY.

13.2 Non-optoisolated RS-485/TTL serial interface EVIF20TSX

13.2.1 Introduction

EVIF20TSX is a TTL/RS-485 non-optoisolated serial interface.

The interface can be used to connect the device to the monitoring and surveillance system of RICS plants or to the data recording device, to download recorded data (via USB), to upload and download the EVUSBREC01 configuration parameters.

The EVIF21TS7I interface is necessary in order to set-up optoisolation.

13.2.2 Description

The following drawing illustrates the aspect of the EVIF20TSX.



The following table illustrates the meaning of the EVIF20TSX parts.

Part	Meaning
1	RS-485 port
2	TTL port

13.2.3 Dimensions

The following drawing illustrates the EVIF20TSX dimensions; these are expressed in mm (in).

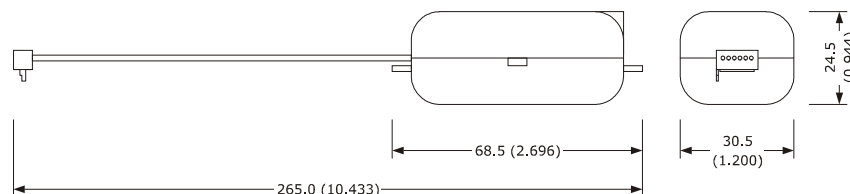

13.2.4 Connection to the device

Operate as follows:

1. Insert the EVIF20TSX TTL port into the device communication port.
2. Connect the EVIF20TSX RS-485 port to the network devices monitored and supervised by RICS or EVUSBREC01.

For further information, consult the documentation relative to RICS and EVUSBREC01.

13.3 EVPROG01 connection kit

13.3.1 Introduction

EVPROG01 is a connection kit.

The kit can be used to connect the device to the Parameters Manager set-up software system.

The kit is made up from the following parts:

- non-optoisolated RS-232/TTL serial interface EVIF20TRX
- 1256800042 telephone cable
- 1256800079 adapter.

The kit can be used on condition that the device is powered.

13.3.2 Description

The following drawing illustrates the aspect of EVPROG01.

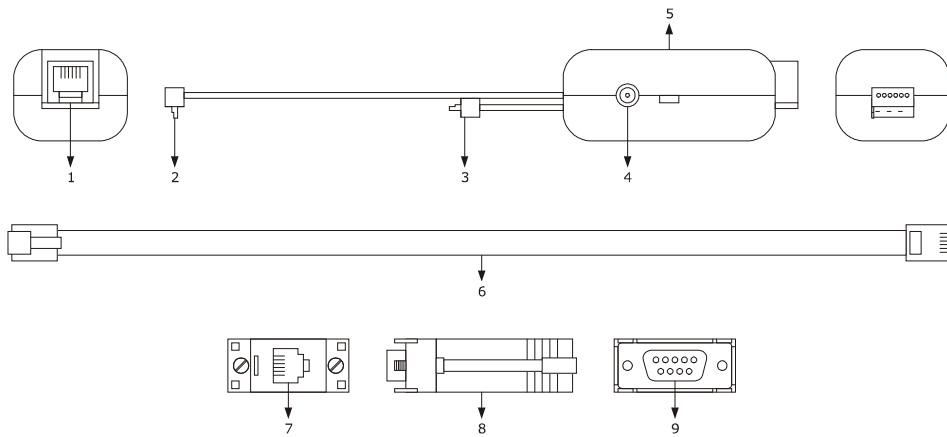

The following table illustrates the meaning of EVIF20TRX parts.

Part	Meaning
1	RS-232 port
2	TTL door on moveable support
3	TTL door on rigid support
4	reserved
5	non-optoisolated RS-232/TTL serial interface EVIF20TRX
6	1256800042 telephone cable
7	port for telephone connector
8	1256800079 adapter
9	RS-232 port

13.3.3 Dimensions

The following drawing illustrates EVPROG01 dimensions; these are expressed in mm (in).

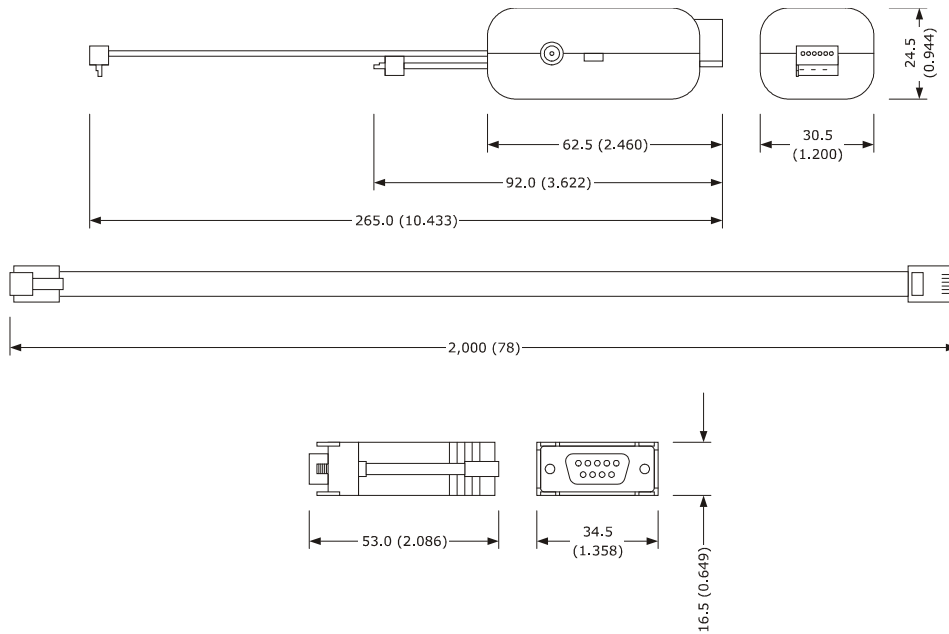

13.3.4 Connection to the device

Operate as follows:

1. Insert the EVIF20TRX TTL port inside the device communication port (use the port on the support that seems easiest to use).
2. Insert one end of the telephone cable 1256800042 into the EVIF20TRX RS-232 port.
3. Insert the other end of the telephone cable 1256800042 into the port 1256800079 adapter telephone cable.
4. Connect the 1256800079 adapter RS-232 port to a Personal Computer COM, in which Parameters Manager is installed.

For further information, consult the documentation relative to Parameters Manager.

14 TECHNICAL DATA

14.1 Technical data

Purpose of the device:	blast chiller controller.	
Execution:	user interface	control module
	board without cover behind a Plexiglas sheet.	board without cover.
Dimensions:	user interface	control module
	290.0 x 50.5 x 38.0 mm (11.417 x 1.988 x 1.496 in; L x H x P).	99.0 x 108.0 x 24.0 mm (3.897 x 4.251 x 23.978 mm; L x H x D).
Installation:	user interface	control module
	rear of panel, with biadhesive tape.	on flat surface, with spacers.
Protection rating:	user interface	control module
	IP65.	IP00.
Connections:	user interface	control module
	fixed screw terminal boards (control module).	fixed screw terminal board (user interface and inputs), 6.3 m faston (0.248 in, power supply and outputs), 6 pole connector (serial port).
	The maximum length of the user interface -control module connection is 20 m (65.614 ft).	
Temperature of use:	from 0 to 55 °C (from 32 to 131 °F).	
Storage temperature:	from -25 to 60 °C (from -13 to 140 F).	
Humidity for use:	from 10% to 90% relative humidity without condensate.	
Pollution situation:	2.	
Power supply:	user interface	control module

	supplied from the control module.	115... 230 VAC ($\pm 15\%$), 50/60 Hz (± 3 Hz), 10 VA max.
Overvoltage category:	III.	
Clock:	incorporated (with condenser).	
	Battery autonomy in the event of a power-cut: 24 h with battery fully charged.	
	Battery charging time: 2 min (the battery is charged by the device power supply).	
Signal buzzer and alarm:	incorporated.	
Analogue inputs:	3 inputs (cabinet probe, needle probe and evaporator probe), can be set via configuration parameter for PTC/NTC probes	
	PTC type analogue inputs (990 Ω @ 25°C, 77°F) Type of sensor: KTY 81-121. Field of measurement: from -50 to 150°C (from -58 to 302°F). Resolution: 0.1 °C (1 °F). Protection: none.	
Digital inputs:	NTC type analogue inputs (10K Ω @ 25°C, 77°F) Type of sensor: $\beta 3435$. Field of measurement: from -40 to 105°C (from -40 to 220°F). Resolution: 0.1 °C (1 °F). Protection: none.	
	2 inputs (door micro switch and high pressure), which can be set via configuration parameter due to normally open contact/normally closed contact (free of voltage contact, 5 VDC, 2 mA)	
Displays:	Digital inputs Power supply: none. Protection: none.	
	custom 4 digit display, with function icon.	

Digital outputs:	5 outputs (electromechanical relays): <ul style="list-style-type: none">- 1 SPST (K1) 30 A res. output @ 250 VAC for compressor management- 2 x 16 A res. outputs @ 250 VAC of which one SPDT (K2) for management of defrosting and one SPST (K4) for management of the door heating elements or of the condenser fan- 2 x 8 A res. outputs @ 250 VAC of which one SPST (KS) for management of the evaporator fan and one SPDT (K5) for management of the cabinet light, needle probe heating or the UV light.
Type of actions and complementary features:	1C.
Communication port:	1 TTL serial port with MODBUS communication protocol

EVF815

Controller in split execution for temperature-controlled blast chillers (with capacitive touch-key user interface, which can be integrated into the unit)

Installer manual ver. 2.0

PT - 27 / 15

Code 144F815E204

This document is exclusive property of Evco; reproduction and disclosure are prohibited without express authorisation from Evco.

Evco is not liable for any features, technical data and possible errors stated in this document or deriving from use of the same.

Evco cannot be considered liable for damage caused by failure to comply with warnings given in this document.

Evco reserves the right to make any changes without forewarning, without jeopardising the basic safety and operating features.



EVCO S.p.A.

Via Feltre 81, 32036 Sedico Belluno ITALY

Phone +39 / 0437 / 84.22

Fax +39 / 0437 / 83.648

info@evco.it

www.evco.it