

EVlinking Wi-Fi

Wi-Fi Module



**IMPORTANT**

Read this document carefully before installation and before using the device and take all the prescribed precautions. Keep this document with the device for future consultation. Only use the device in the ways described in this document.

Index

- 1 INTRODUCTION 4
- 1.1 Initial information 4
- 1.2 Main features 4
- 1.3 Schematic diagram..... 4
- 2 DESCRIPTION 5
- 2.1 Description EVIF25TWX 5
- 2.2 Description EVIF25SWX 5
- 3 MEASUREMENTS AND INSTALLATION 5
- 3.1 Measurements and installation EVIF25TWX 5
- 3.2 Measurements and installation EVIF25SWX 5
- 4 ELECTRICAL CONNECTION 6
- 4.1 Example of controller label 6
- 4.2 Electrical connection of EVIF25TWX to a controller able to power EVlinking Wi-Fi 6
- 4.3 Electrical connection of EVIF25TWX to a controller unable to power EVlinking Wi-Fi..... 6
- 4.4 Electrical connection of EVIF25SWX to a controller able to power EVlinking Wi-Fi 7
- 4.5 Electrical connection of EVIF25SWX to a controller unable to power EVlinking Wi-Fi..... 7
- 5 FIRST-TIME USE 8
- 5.1 First-time use of EVlinking Wi-Fi 8
- 5.2 Description of the EVlinking Wi-Fi LEDs.....13
- 5.3 First access to the cloud server.....13
- 6 SUBSEQUENT USES15
- 6.1 Subsequent uses of EVlinking Wi-Fi15
- 6.2 Subsequent accesses to the cloud server16
- 7 RESETTING THE FACTORY SETTINGS.....17
- 8 TECHNICAL SPECIFICATIONS18

1 INTRODUCTION

1.1 Initial information

EVlinking Wi-Fi is a hardware module with Wi-Fi connectivity that can be connected to our EPoCA compatible controllers to access the functions of the EPoCA cloud platform or those of other control or data acquisition systems using the MODBUS TCP protocol.

The EVlinking Wi-Fi module can also be connected to third-party devices using the MODBUS RTU protocol on the RS-485 port to allow integration with client systems.

1.2 Main features

Purchasing code	EVIF25TWX	EVIF25SWX
Power supply	controller-powered (depending on the type of controller) or independently powered 12 VAC/15 VDC	controller-powered (depending on the type of controller) or independently powered 12 VAC/15 VDC
Clock	•	•
Communications port	TTL MODBUS	RS-485 MODBUS

	<p>N.B. The compatibility of the controller with the EPoCA system and the possibility of powering EVlinking Wi-Fi from the controller depend on the type of controller. See the document "EPoCA - List of compatible controllers" available on the website www.evco.it and/or the label on the controller.</p>
---	---

1.3 Schematic diagram

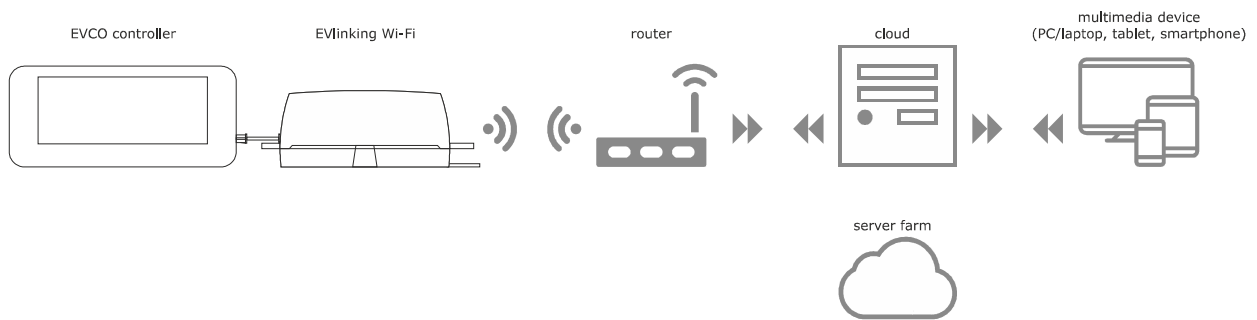

2 DESCRIPTION

2.1 Description EVIF25TWX

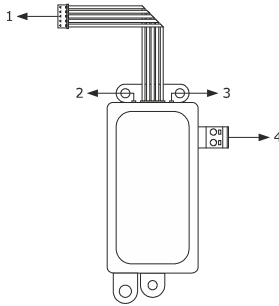

Part	Description
1	Pico-Blade connector (TTL MODBUS port)
2	Red LED (MODBUS communication status)
3	Green LED (Wi-Fi communication status)
4	Plug-in screw terminal block (independent power supply)

2.2 Description EVIF25SWX

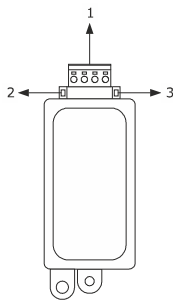

Part	Description
1	Plug-in screw terminal block (RS-485 MODBUS port)
2	Red LED (MODBUS communication status)
3	Green LED (Wi-Fi communication status)

3 MEASUREMENTS AND INSTALLATION

Measurements in mm (inches); to be fitted to a hard surface with a cable tie (not provided).

3.1 Measurements and installation EVIF25TWX

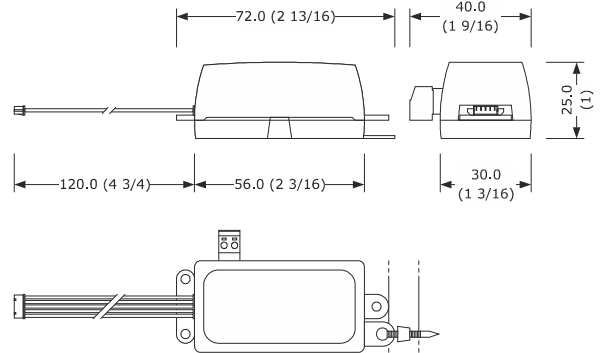

3.2 Measurements and installation EVIF25SWX

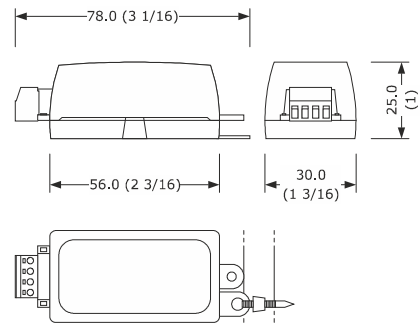

INSTALLATION PRECAUTIONS

- Ensure that the working conditions are within the limits stated in the TECHNICAL SPECIFICATIONS section
- Install the device where the Wi-Fi signal is strong
- Do not install the device close to metal parts which may impede Wi-Fi communication
- Do not install the device close to heat sources, equipment with a strong magnetic field, in places subject to direct sunlight, rain, damp, excessive dust, mechanical vibrations or shocks
- In compliance with safety regulations, the device must be installed properly to ensure adequate protection from contact with electrical parts. All protective parts must be fixed in such a way as to need the aid of a tool to remove them

4 ELECTRICAL CONNECTION

	N.B.
	- The compatibility of the controller with the EPoCA system and the possibility of powering EVlinking Wi-Fi from the controller depend on the type of controller. See the document "EPoCA - List of compatible controllers" available on the website www.evco.it and/or the label on the controller
	- Do not power more than one EVlinking Wi-Fi with the same power supply
	- If EVlinking Wi-Fi is to be independently powered, do not power it with the same power supply as the controller connected to EVlinking Wi-Fi
	- The battery of EVlinking Wi-Fi is charged by the power supply of the device or by the independent power supply: for correct operation, the battery must be fully charged at least once a year
	- To reduce any electromagnetic interference, locate the power cables as far away as possible from the signal cables

4.1 Example of controller label

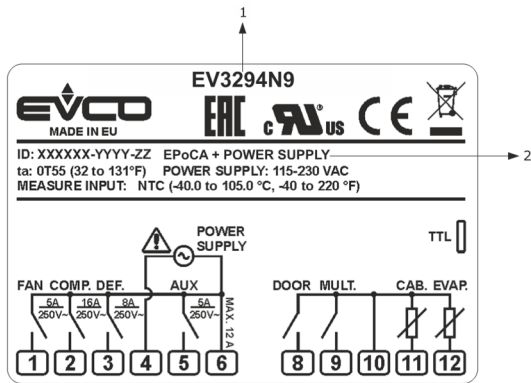

Part	Description						
1	Purchasing code						
2	Additional information						
	<table border="1"> <thead> <tr> <th>Abbreviation</th> <th>Meaning</th> </tr> </thead> <tbody> <tr> <td>EPoCA + POWER SUPPLY</td> <td>The controller is compatible with the EPoCA system and is able to power EVlinking Wi-Fi</td> </tr> <tr> <td>EPoCA + EXT. POWER SUPPLY</td> <td>The controller is compatible with the EPoCA system but the EVlinking Wi-Fi module must be independently powered</td> </tr> </tbody> </table>	Abbreviation	Meaning	EPoCA + POWER SUPPLY	The controller is compatible with the EPoCA system and is able to power EVlinking Wi-Fi	EPoCA + EXT. POWER SUPPLY	The controller is compatible with the EPoCA system but the EVlinking Wi-Fi module must be independently powered
Abbreviation	Meaning						
EPoCA + POWER SUPPLY	The controller is compatible with the EPoCA system and is able to power EVlinking Wi-Fi						
EPoCA + EXT. POWER SUPPLY	The controller is compatible with the EPoCA system but the EVlinking Wi-Fi module must be independently powered						

4.2 Electrical connection of EVIF25TWX to a controller able to power EVlinking Wi-Fi

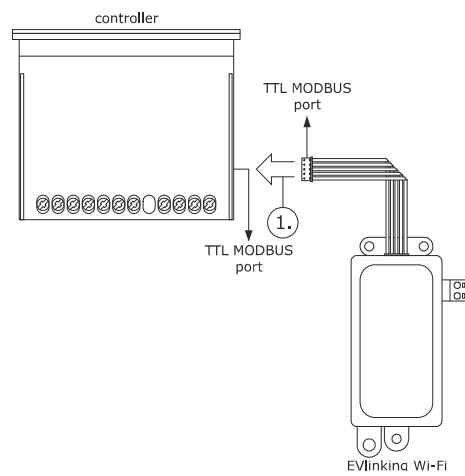

1. Connect the TTL MODBUS port on the EVlinking Wi-Fi to the TTL MODBUS port on the controller.
Before powering up the controller, see the section FIRST-TIME USE.

4.3 Electrical connection of EVIF25TWX to a controller unable to power EVlinking Wi-Fi

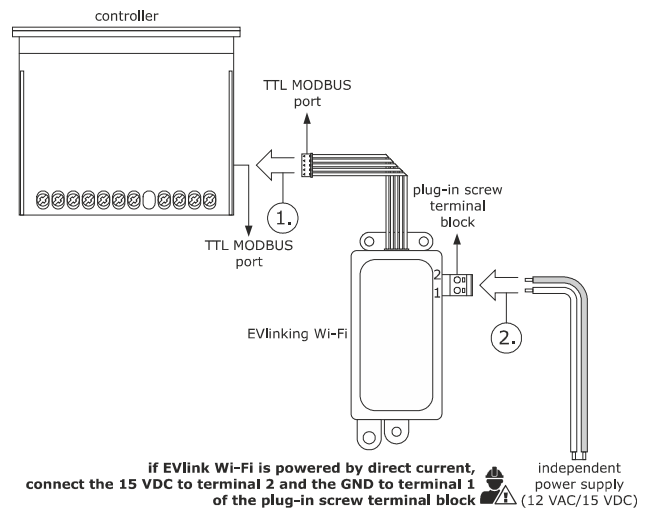

1. Connect the TTL MODBUS port on the EVlinking Wi-Fi to the TTL MODBUS port on the controller.
2. 2.1 Connect the end of an independent power supply cable to terminal 1 of the plug-in screw terminal block on EVlinking Wi-Fi.
- 2.2 Connect the end of the other independent power supply cable to terminal 2 of the plug-in screw terminal block on EVlinking Wi-Fi.

Before powering up the controller and EVlinking Wi-Fi, see the section FIRST-TIME USE.

4.4 Electrical connection of EVIF25SWX to a controller able to power EVlinking Wi-Fi

	<p>N.B.</p> <ul style="list-style-type: none"> - Connect the RS-485 using a twisted pair - The maximum permitted length of the RS-485 connection cables is 1000 m (3280 ft) and enables EVlinking Wi-Fi to be installed in the most convenient place. Make sure that the voltage supplied to EVlinking Wi-Fi is within the limits set in the section TECHNICAL SPECIFICATIONS
---	---

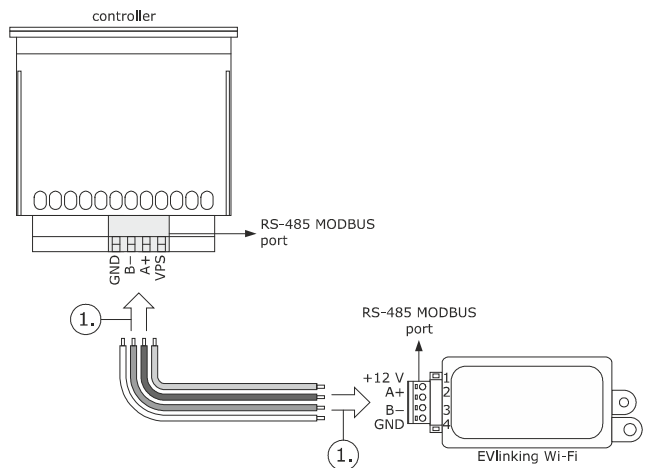

1. 1.1 Connect terminal 4 of the EVlinking Wi-Fi RS-485 MODBUS (GND) port to the GND terminal of the RS-485 MODBUS port of the controller.
- 1.2 Connect terminal 3 of the EVlinking Wi-Fi RS-485 MODBUS (B-) port to the B- terminal of the RS-485 MODBUS port of the controller.
- 1.3 Connect terminal 2 of the EVlinking Wi-Fi RS-485 MODBUS (A+) port to the A+ terminal of the RS-485 MODBUS port of the controller.
- 1.4 Connect terminal 1 of the EVlinking Wi-Fi RS-485 MODBUS (+12 V) port to a terminal on the controller that is able to supply 12 VAC/15 VDC (VPS).

Before powering up the controller and EVlinking Wi-Fi, see the section FIRST-TIME USE.

4.5 Electrical connection of EVIF25SWX to a controller unable to power EVlinking Wi-Fi

	<p>N.B.</p> <p>Connect the RS-485 using a twisted pair</p>
---	--

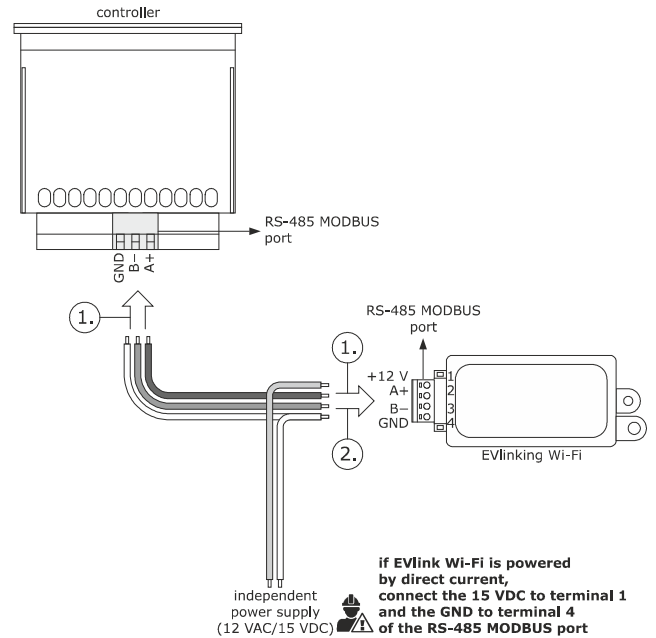

1. 1.1 Connect terminal 4 of the EVlinking Wi-Fi RS-485 MODBUS (GND) port to the GND terminal of the RS-485 MODBUS port of the controller.
- 1.2 Connect terminal 3 of the EVlinking Wi-Fi RS-485 MODBUS (B-) port to the B- terminal of the RS-485 MODBUS port of the controller.
- 1.3 Connect terminal 2 of the EVlinking Wi-Fi RS-485 MODBUS (A+) port to the A+ terminal of the RS-485 MODBUS port of the controller.
2. 2.1 Connect terminal 4 of the EVlinking Wi-Fi RS-485 MODBUS (GND) port to the end of an independent power supply cable.
- 2.2 Connect terminal 1 of the EVlinking Wi-Fi RS-485 MODBUS (+12 V) port to the end of the other independent power supply cable.

Before powering up the controller and EVlinking Wi-Fi, see the section FIRST-TIME USE.

PRECAUTIONS FOR ELECTRICAL CONNECTION

- If the device is moved from a cold to a warm place, humidity may cause condensation to form inside. Wait for about an hour before connecting it to the controller or the independent power supply
- Disconnect the device from the controller or the independent power supply before carrying out any type of maintenance
- For repairs and for further information, contact the EVCO sales network

5 FIRST-TIME USE

	<p>N.B.</p> <ul style="list-style-type: none"> - EVlinking Wi-Fi uses an encrypted connection with TLS technology and occupies the TCP 8883 port. Make sure this firewall port (both the port of the user's local network and the one managed by the Internet service provider) is open for outgoing communications (contact the IT manager) - Ensure the user has a multimedia device (PC/laptop, tablet, smartphone) with a web browser installed and that the device is able to upload and download files. If the device has an iOS operating system, files can only be uploaded and downloaded if the user has an iCloud account and if access to this service has previously been made with the device - Ensure the Wi-Fi on the device is on
---	---

In the **Security key** field enter the password found on the label of the EVlinking Wi-Fi (typically **epocawifi**).

8. Open the web browser on the multimedia device.
Enter the address found on the label of the EVlinking Wi-Fi (typically **192.168.4.1**) in the address bar.



5.1 First-time use of EVlinking Wi-Fi

1. Power up the controller and make sure the bLE parameter (enable EVlinking) is set to 1; see the controller instructions.
2. Disconnect the controller.
3. Carry out the installation of EVlinking Wi-Fi as shown in the section MEASUREMENTS AND INSTALLATION.
4. Connect EVlinking Wi-Fi as shown in the section ELECTRICAL CONNECTION.
5. Power up the controller and connect the independent EVlinking Wi-Fi power supply, if used, to the power source.
EVlinking Wi-Fi will be in *temporary set-up mode*. During this mode:
 - EVlinking Wi-Fi acts as both an access point (identifying a Wi-Fi network called **Epoca** followed by 6 alphanumeric characters, for example **Epoca279A8E**) and a data logger for the connected controller
 - there is no connection with the cloud server.

After 120 s (600 for the first-time use) in *set-up mode*, EVlinking Wi-Fi will automatically go into *run mode* if the control panel has not been accessed (point 9 of this paragraph). During this mode:

 - EVlinking Wi-Fi acts as a data logger for the connected controller
 - there is no connection with the cloud server.
6. Scan the Wi-Fi networks using the multimedia device and identify a network called **Epoca** followed by 6 alphanumeric characters.



If the scan detects more than one network called **Epoca**, make sure only one EVlinking Wi-Fi is being powered.

7. Connect to the **Epoca** network.

9. The **Home** screen of the EVlinking Wi-Fi control panel will be displayed.
 EVlinking Wi-Fi will be in *temporary set-up mode*. During this mode:
- EVlinking Wi-Fi acts as an access point but it cannot be accessed with another multimedia device
 - there is no connection with the cloud server.

After 5 min in *set-up mode*, EVlinking Wi-Fi will automatically go into *run mode* if the control panel has not been accessed.

countdown to automatically go into "run mode" ← 855 seconds to run mode

saves the settings and goes into "run mode"
N.B.: the settings are not saved when the web browser is closed
 does not save the settings and goes into "run mode"

Home Plant WLAN Time Modbus Firmware

Firmware version 913.0.11 → firmware version

MAC address a4:e5:7c:2f:9a:81 → MAC address

Status
 ✓ Real Time Clock
 ✓ Logging capability
 ✓ Serial link
 ✓ EPoCA compliant
 ✗ Broker connected
 ✗ IP address assigned → status

Plant ident. → plant identity

Vendor ident. → unused

Paired controller ident. 031002E570D534230372039 → last coupled controller identity

Current controller ident. 031002E570D534230372039 → connected controller identity

Save and Quit Discard and Quit

10. Select the **Plant** screen on the EVlinking Wi-Fi control panel. The fields in red are mandatory.

891 seconds to run mode

Save and Quit Discard and Quit

Home Plant WLAN Time Modbus Firmware

Plant name * → plant name, for example **Blacks Supermarket**; this name must be the same for all the EVlinking Wi-Fi devices in the plant

Password * → password plant

Confirm password * → confirm plant password

Plant category → optional

Unit name * → optional

Unit serial no. → unit name, for example **Cold room**

Save → saves settings on the **Plant** screen and remains in the control panel

Download
 Click [here](#) to export the plant file **from** this gateway.

Upload
 Import a configuration file **into** this gateway.
 Review unit name and IP address, then save the changes.
 Select a file Nessun file selezionato

Upload → uploads the configuration file of an EVlinking Wi-Fi which has already been configured

downloads the EVlinking Wi-Fi configuration file ("plant file") on the multimedia device; keep this file to upload the configuration to other EVlinking Wi-Fi devices in the same plant and to the cloud server

selects the configuration file of an EVlinking Wi-Fi which has already been configured to upload the configuration to other EVlinking Wi-Fi devices in the same plant; then differentiate the unit name and the settings of the **WLAN** screen

11. Select the **WLAN** screen on the EVlinking Wi-Fi control panel. The fields in red are mandatory.

833 seconds to run mode

Save and Quit Discard and Quit

Home Plant **WLAN** Time Modbus Firmware

IP assignment Static Dynamic

Detected networks* (scan every 20 sec) Filter: Regular expressio Scanning... please wait

Network name Wi-Fi networks detected

Security key security key of the Wi-Fi network

Connect to cloud Yes No

Broker location Default Custom

Send all historical entries

Connect Test broker

833 seconds to run mode

assigns a static IP address (Static, typical of large local networks and assigned manually by an IT manager) or a dynamic IP address (Dynamic, typical of medium/small local networks and assigned automatically by a router)

invia i dati del controllore (Yes) o meno (No) al server cloud

unused (do not change)

unused

connects the Wi-Fi network and saves the settings

carries out a broker test; used for diagnostic purposes after the connection to the Wi-Fi network

If the IP addresses are statically assigned, select the **Static** button.

770 seconds to run mode

Save and Quit Discard and Quit

Home Plant **WLAN** Time Modbus Firmware

IP assignment Static Dynamic

IP address IP address

Subnet mask subnet mask

Gateway gateway

Primary DNS primary DNS

Secondary DNS secondary DNS

Detected networks* (scan every 20 sec) Filter: Regular expressio Scanning... please wait

Network name Wi-Fi networks detected

Security key security key of the Wi-Fi network

Connect to cloud Yes No

Broker location Default Custom

Send all historical entries

Connect Test broker

770 seconds to run mode

assigns a static IP address (Static, typical of large local networks and assigned manually by an IT manager) or a dynamic IP address (Dynamic, typical of medium/small local networks and assigned automatically by a router)

sends (Yes)/does not send (No) the controller data to the cloud server

unused (do not change)

unused

connects the Wi-Fi network and saves the settings

carries out a broker test; used for diagnostic purposes after the connection to the Wi-Fi network

12. Select the **Time** screen on the EVlinking Wi-Fi control panel.

The screenshot shows the 'Time' configuration screen of the EVlinking Wi-Fi control panel. At the top, it displays '894 seconds to run mode' and two buttons: 'Save and Quit' and 'Discard and Quit'. Below this is a navigation bar with tabs for 'Home', 'Plant', 'WLAN', 'Time' (selected), 'Modbus', and 'Firmware'. The main content area includes several settings:

- Read clock:** A 'Go' button that reads the time of the EVlinking Wi-Fi clock.
- Write clock:** A 'Go' button that updates the time of the EVlinking Wi-Fi clock to that of the multimedia device in use.
- Time zone:** Two input fields for hours and minutes, followed by '[hh:mm]', used to establish a time zone with respect to UTC time.
- Synchronize clock with cloud:** A checkbox that updates the EVlinking Wi-Fi clock time to UTC.
- Clear historical records:** A 'Go' button that deletes the data acquired by EVlinking Wi-Fi.
- Daylight saving time:** A section with an 'Adjust automatically' dropdown menu currently set to 'Disabled'. This setting establishes the geographical area of belonging (European Union, North America or Pacific) and automatically updates or not (Disabled) the time of the EVlinking Wi-Fi clock in the transition from summer to winter time (and vice versa).

establishes the geographical area of belonging (**European Union**, **North America** or **Pacific**) and automatically updates or not (**Disabled**) the time of the EVlinking Wi-Fi clock in the transition from summer to winter time (and vice versa)

13. Select the **Modbus** screen on the EVlinking Wi-Fi control panel.

894 seconds to run mode

Save and Quit Discard and Quit

Home Plant WLAN Time Modbus Firmware

Enable Modbus TCP

Delay after boot 6300 ms

Modbus RTU

Timeout 200 ms

Idle time 0 ms

establishes whether to enable the Modbus TCP communication

establishes the minimum time that elapses between the restart of the controller and the start of communication

establishes the maximum time allowed to the controller for answer a request

establishes the minimum time that elapses between the receipt of a response from the controller and the next request

If Modbus TCP communication is not enabled, the device will only work with EPoCA compatible controllers.
 If you want to enable Modbus TCP communication, select the checkbox **Enable Modbus TCP**.

3 seconds to run mode

Save and Quit Discard and Quit

Home Plant WLAN Time Modbus Firmware

Enable Modbus TCP

Operation mode Cloud

Delay after boot 6300 ms

Modbus RTU

Timeout 200 ms

Idle time 0 ms

Modbus TCP

Listening port 502 s

Connection timeout 180 s

Exception on timeout

establishes the operating mode (Raw bridge for EVCO controllers without real-time functions and not compatible with the EPoCA system and for third-party controllers, Bridge + Sync RTC for EVCO controllers with real-time functions and not with the EPoCA system, Cloud for controllers compatible with the EPoCA system); if the operating mode is not compatible with the connected controller, EVlinking Wi-Fi will automatically change it to one of those available

establishes whether to enable the Modbus TCP communication

establishes the minimum time that elapses between the restart of the controller and the start of communication

establishes the maximum time allowed to the controller for answer a request

establishes the minimum time that elapses between the receipt of a response from the controller and the next request

establishes the Modbus TCP port number on which the device waits for connection requests

establishes the inactivity time of the Modbus RTU communication such as to close the connection

establishes whether to send an error code after the Timeout time has elapsed

14. Select the **Firmware** screen on the EVlinking Wi-Fi control panel.

894 seconds to run mode

Save and Quit Discard and Quit

Home Plant WLAN Time Modbus Firmware

Update the firmware running in this gateway.
 Current settings will be lost !

Select a file Scegli file Nessun file selezionato

Update

selects the file to update the EVlinking Wi-Fi firmware

updates the Evlinking Wi-Fi firmware with the selected file

N.B.: updating the EVlinking Wi-Fi firmware may delete the settings on the Plant and WLAN screens

15. Disconnect the controller and disconnect the independent EVlinking Wi-Fi power supply, if used, from the power source.

16. Power up the controller.

17. Connect the independent EVlinking Wi-Fi power supply, if used, to the power source.

5.2 Description of the EVlinking Wi-Fi LEDs

LED	ON	OFF	SLOW FLASH	RAPID FLASH
red (MODBUS communication status)	-	no MODBUS activity	MODBUS activity	-
green (Wi-Fi communication status)	connection with both the Wi-Fi network and the cloud server		no connection with the Wi-Fi network	connection with the Wi-Fi network, no connection with the cloud server

5.3 First access to the cloud server

1. Open the web browser on the multimedia device and open the web page **epoca.cloud**. The **Login** screen will be displayed.

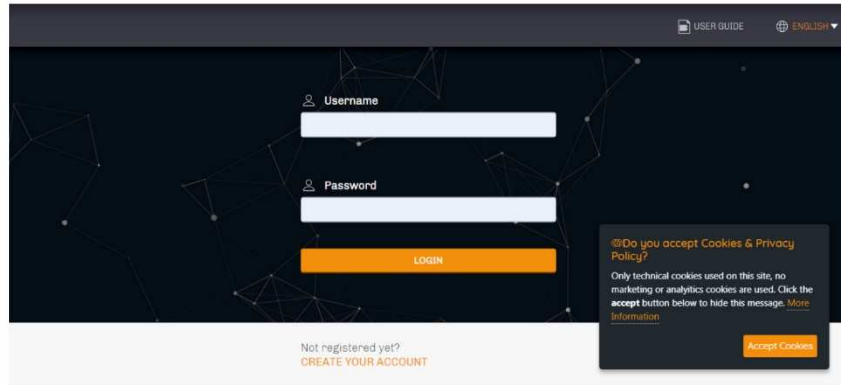

2. Select **CREATE NEW ACCOUNT**. The **New account** screen will be displayed.

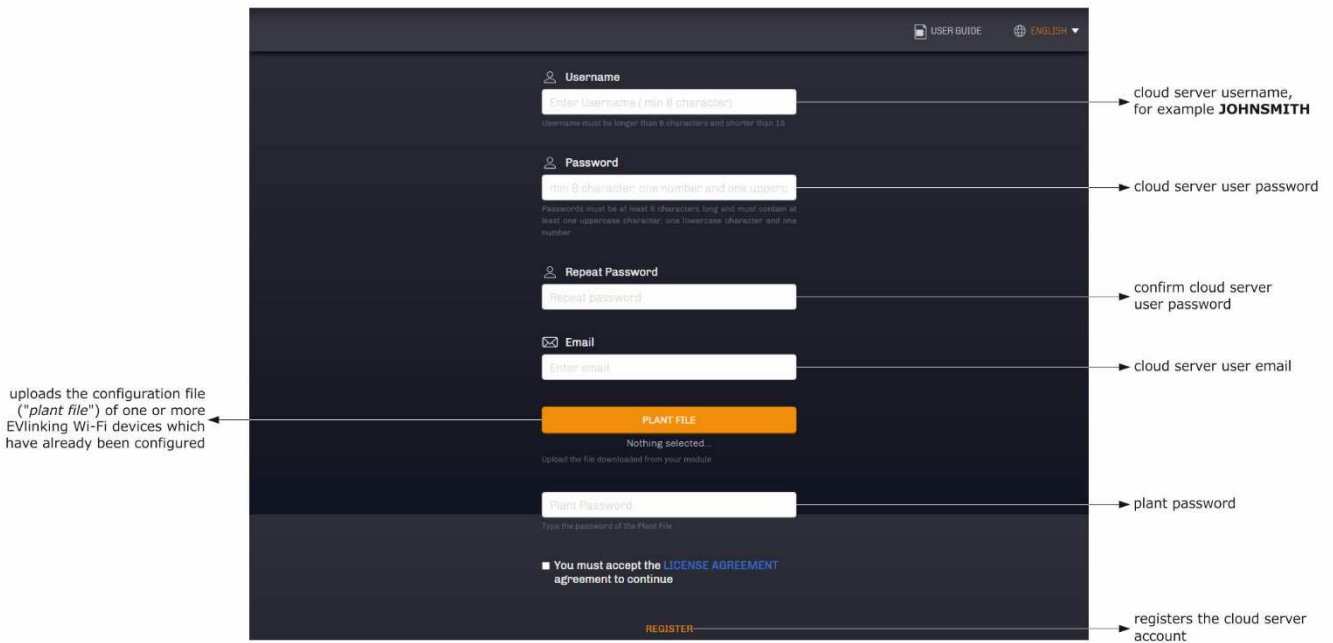

3. Select **REGISTER**. The **Account created OK** screen will be displayed.

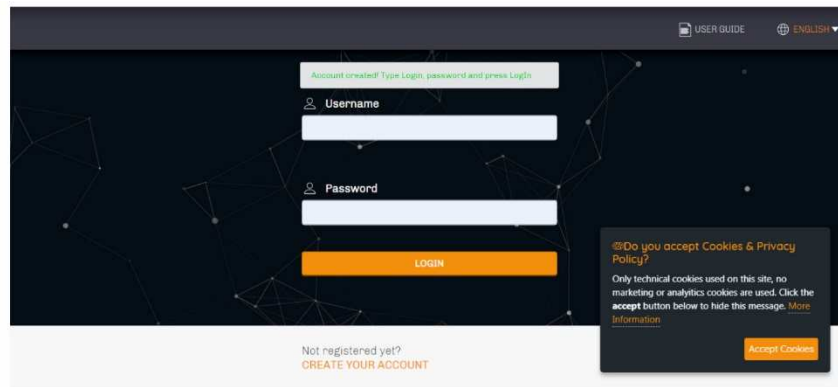

6 SUBSEQUENT USES

	N.B. Any modifications to the configuration of EVlinking Wi-Fi must be made on site on all the EVlinking Wi-Fi devices in the same plant
---	---

6.1 Subsequent uses of EVlinking Wi-Fi

- Scan the Wi-Fi networks using the multimedia device and identify a network called **Epoca** followed by 6 alphanumeric characters and the name of the device, for example **Epoca279A8E Cold room**.



- Connect to the **Epoca** network.
In the **Security key** field enter the password found on the label of the EVlinking Wi-Fi (typically **epocawifi**).
- Open the web browser on the multimedia device.
Enter the address found on the label of the EVlinking Wi-Fi (typically **192.168.4.1**) in the address bar.



- The **Login** screen will be displayed.

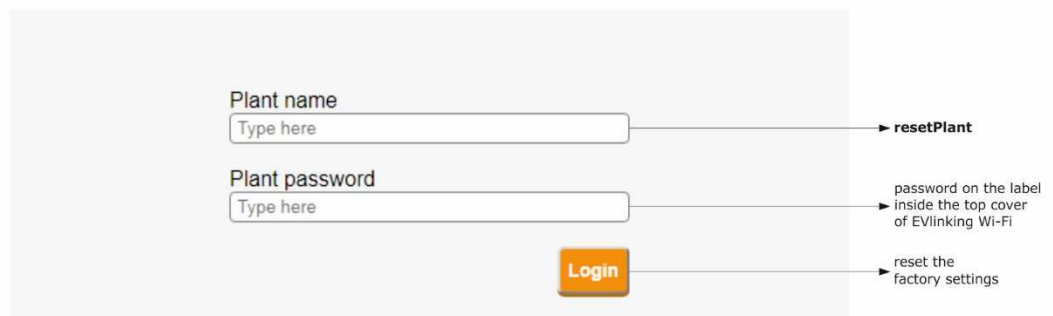

6.2 Subsequent accesses to the cloud server

1. Open the web browser on the multimedia device and open the web page **epoca.cloud**. The **Login** screen will be displayed.

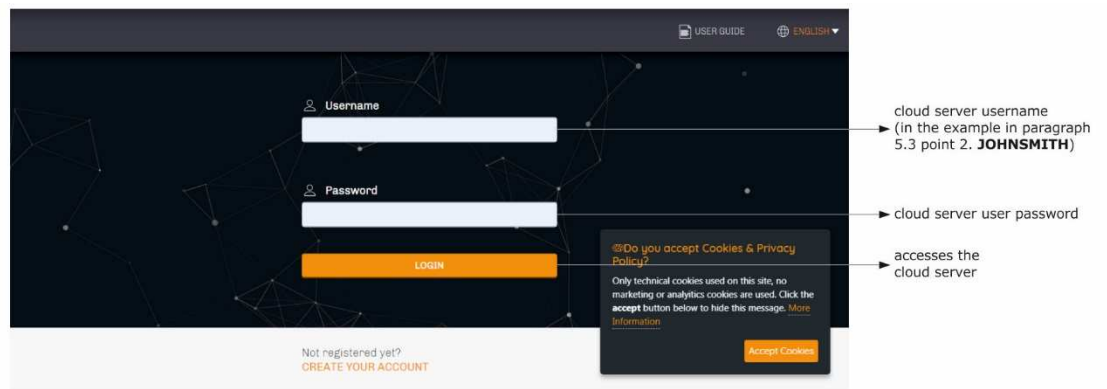

7 RESETTING THE FACTORY SETTINGS

	<p>N.B. Resetting the factory settings deletes the settings on the Plant and WLAN screens but does not cancel the data recorded by the EVlinking Wi-Fi data logger.</p>
---	---

1. Disconnect the controller and any independent power supply to EVlinking Wi-Fi from the power source.
2. Remove the top cover of EVlinking Wi-Fi by gently applying pressure with a screwdriver in the slot.

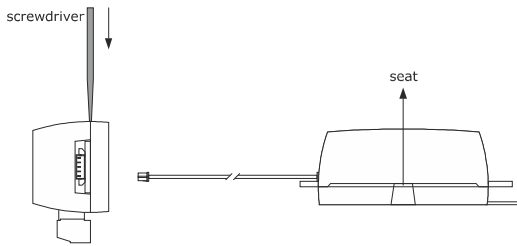

3. Make a note of the password on the label inside the top cover of EVlinking Wi-Fi.

1234567890ABCDEF

4. Click the top cover of EVlinking Wi-Fi back into place.
5. Power up the controller and connect the independent EVlinking Wi-Fi power supply, if used, to the power source.

6. Scan the Wi-Fi networks using the multimedia device and identify a network called **Epoca** followed by 6 alphanumeric characters and the name of the device, for example **Epoca279A8E Cold room**.



7. Connect to the **Epoca** network.
In the **Security key** field enter the password found on the label of the EVlinking Wi-Fi (typically **epocawifi**).
8. Open the web browser on the multimedia device.
Enter the address found on the label of the EVlinking Wi-Fi (typically **192.168.4.1**) in the address bar.



9. The **Login** screen will be displayed.
Type in **resetPlant** in the **Plant name** field. Enter the password found on the label inside the top cover of EVlinking Wi-Fi in the **Plant password** field.

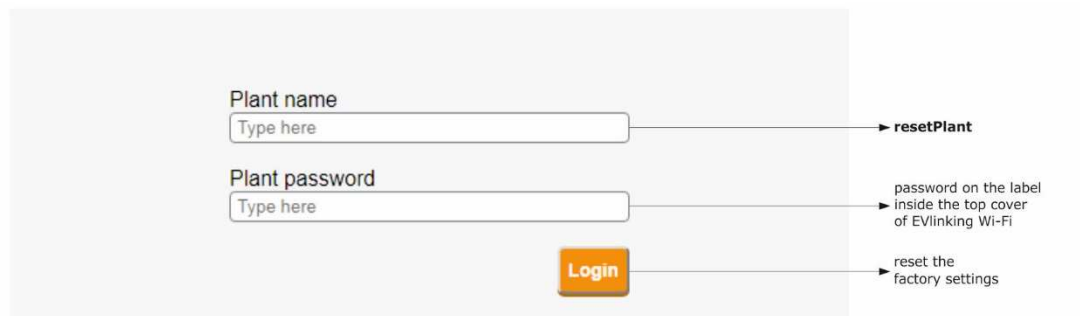

8 TECHNICAL SPECIFICATIONS

Housing	black, self-extinguishing
Category of heat and fire resistance	D
Measurements	
for EVIF25TWX	176.0 x 30.0 x 25.0 mm (6 15/16 x 1 3/16 x 1 in)
for EVIF25SWX	56.0 x 30.0 x 25.0 mm (2 3/16 x 1 3/16 x 1 in)
Mounting method for the device	on a hard surface with a cable tie (provided)
Degree of protection provided by the casing	IP00
Connection method	
for EVIF25TWX	plug-in screw terminal block for wires up to 1.5 mm ² , Pico-Blade connector
for EVIF25SWX	plug-in screw terminal block for wires up to 1.5 mm ²
Maximum permitted length for connection cables	
power supply: 10 m (32.8 ft)	RS-485 MODBUS port: 1000 m (3280 ft)
Operating temperature	from 0 to 55 °C (from 32 to 131 °F).
Storage temperature	from -25 to 70 °C (from -13 to 158 °F)
Operating humidity	relative humidity without condensate from 10 to 90 %
Compliance	
RoHS 2011/65/EC	WEEE 2012/19/EU
REACH (EC) Regulation no. 1907/2006	RED 2014/53/EU
Power supply	powered by the controller (depending on the type of controller) or independently powered 12 VAC ±15% or 15 VDC ±15%, 50/60 Hz (±3 Hz), max. 3.2 VA/2W
Software class and structure	A
Clock	secondary lithium battery
Clock drift	≤ 60 s/month at 25 °C (77 °F)
Clock battery autonomy in the absence of a power supply	> 6 months at 25 °C (77 °F)
Clock battery charging time	24 h (the battery is charged by the power supply of the device or by the independent power supply) for correct operation, the battery must be fully charged at least once a year
Displays	
MODBUS communication status LED	Wi-Fi communication status LED
Communications ports	
for EVIF25TWX	TTL MODBUS
for EVIF25SWX	RS-485 MODBUS
Connectivity	Wi-Fi
Wi-Fi output power (EIRP)	11b: 67.5 mW and 11g: 71.1 mW, 11n (HT20) 56.5 mW
Wi-Fi frequency range	2,412... 2,472 GHz
Security protocols	open, WEP, WPA/WPA2 Personal aka PSK
Encryption methods	TKIP, CCMP
Unsupported modes	mixed WPA/WPA2 PSK using TKIP + CCMP WPA/WPA2 Enterprise aka EAP

9 SIMPLIFIED EU DECLARATION OF CONFORMITY

EVCO S.p.A. declares that the type of radio equipment:

- EVIF25TWX
- EVIF25SWX

complies with directive 2014/53/EU and directive 2011/65/EU.

The full text of the EU declaration of conformity is available at the following internet address: <https://www.evco.it/en/16434-evlinking-wi-fi>

EVlinking Wi-Fi
Installer manual ver. 4.1 rev. B
PT - 35/22
Code 144IF25TWXE414

	<p>N.B. The device must be disposed of according to local regulations governing the collection of electrical and electronic equipment.</p>
---	--

This document and the solutions contained therein are the intellectual property of EVCO and thus protected by the Italian Intellectual Property Rights Code (CPI). EVCO imposes an absolute ban on the full or partial reproduction and disclosure of the content other than with the express approval of EVCO. The customer (manufacturer, installer or end user) assumes all responsibility for the configuration of the device. EVCO accepts no liability for any possible errors in this document and reserves the right to make any changes, at any time without prejudice to the essential functional and safety features of the equipment.



EVCO S.p.A.

Via Feltre 81, 32036 Sedico (BL) ITALY

phone +39 0437 8422 **fax** +39 0437 83648

email info@evco.it **web** www.evco.it