

Applications

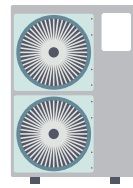

Heat pump

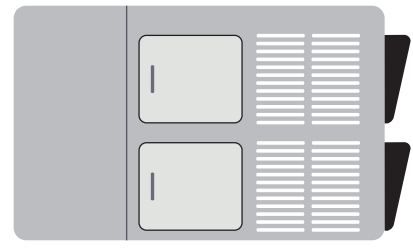

Air Handling Unit

EPJcolor

Remote User Interfaces

- | Built-in RTC and alarm buzzer
- | It can operate in "browser" mode or as a "controller"
- | IP65 front with continuous surface
- | Panel- or wall mounted
- | CAN, RS-485 and USB communication ports
- | Colour full touch-screen TFT graphic display
- | Intuitive customizable and portable application software



USE

Device for indoor applications



IMPORTANT

Read this document thoroughly before installation and before use of the device and follow all recommendations; keep this document with the device for future consultation. Only use the device in the way described in this document; do not use the same as a safety device



CONSIDER THE ENVIRONMENT

Please read carefully and save this document



DISPOSAL

The device must be disposed of in compliance with local standards regarding the collection of electric and electronic equipment

Index

Introduction	5
Purchasing codes	6
Purchasing codes description	6
Dimensions	7
Models for panel mounting	7
Models for wall mounting	7
Installation	8
Models for panel mounting	8
To be fitted to a panel with elastic holding flaps	8
Models for wall mounting	9
A) Wall mounting	9
B) Flush mounting box	9
Electrical connections	10
Models for panel mounting	10
Connectors and parts	10
Electrical connection with independent power supply	11
Electrical connection with device powered by a controller	11
Termination of the RS-485 MODBUS and CAN network	11
Models for wall mounting	12
Connectors and parts	12
Electrical connection with independent power supply	13
Electrical connection with device powered by a controller	13
Termination of the RS-485 MODBUS and CAN network	13
User interface	14
Sensitive areas description	14
Switching ON/OFF the device	14
Menu settings	15
Sensitive areas description and parameters settings	15
Sensitive areas	15
Parameters settings	15
Technical data	20

Introduction

EPJcolor is a range of remote user interfaces that can be used in a wide range of applications in a vast number of different sectors.

The user interface has a TFT touch-screen colour graphic display than can either be panel or wall mounted, thus making it suitable for both residential or business environments.

The development environment for **UNI-PRO 3** programmable controllers makes possible the intuitive personalisation of both the application software and the graphics.

Highly evolved graphics and user navigation options can be set up using a wide range of libraries and templates.

Moreover, the ability to import fonts, load bitmaps and text translation files automatically from a USB flash drive simplify the human-machine interface personalisation process.

EPJcolor can operate in browser mode, i.e. as a controller display, or as a controller with an on-board regulation program and data-logging and MODBUS master/slave communications possibilities.



Purchasing codes

The following table shows the available EPJcolor models and the relative purchasing codes

Features	Models	
	EPJC900X4 *)	EPJC900X4VW *)
Power supply		
24 VAC/DC	•	•
User interface		
320 x 240 pixel colour touch-screen TFT graphic display - 3.5"	•	•
Installation mode		
Panel mounting	•	
Wall mounting		•
CONNECTIONS		
Fixed screw terminal blocks		•
Plug-in screw terminal blocks	•	
Communication ports		
RS-485 MODBUS master/slave	1	1
CAN	1	1
USB	1	1
Other Features		
Real time clock	•	•
Alarm and signalling buzzer	•	•

*) For graphic tools other than UNI-PRO 3, contact the EVCO sales network for the right code number

For further informations look at chapter "Technical data"

Purchasing codes description

Features	Codes
24 VAC/DC - Colour touch-screen - Panel mounting - RS485 - CAN - USB - Real time clock - Alarm and signalling buzzer	EPJC900X4
24 VAC/DC - Colour touch-screen - Wall mounting - RS485 - CAN - USB - Real time clock - Alarm and signalling buzzer	EPJC900X4VW

Dimensions

Models for panel mounting



WARNINGS

- The thickness of a metal panel must be between 0.8 and 1.5 mm ($\frac{1}{32}$ and $\frac{1}{16}$ in), while that for a plastic panel must be between 0.8 and 3.4 mm ($\frac{1}{32}$ and $\frac{1}{8}$ in)
- The measurements of drilling template must be 107.6 x 72.6 mm ($3\frac{15}{16}$ x $2\frac{7}{8}$ in), with rounded corners R 3.0 mm ($\frac{1}{8}$ in)

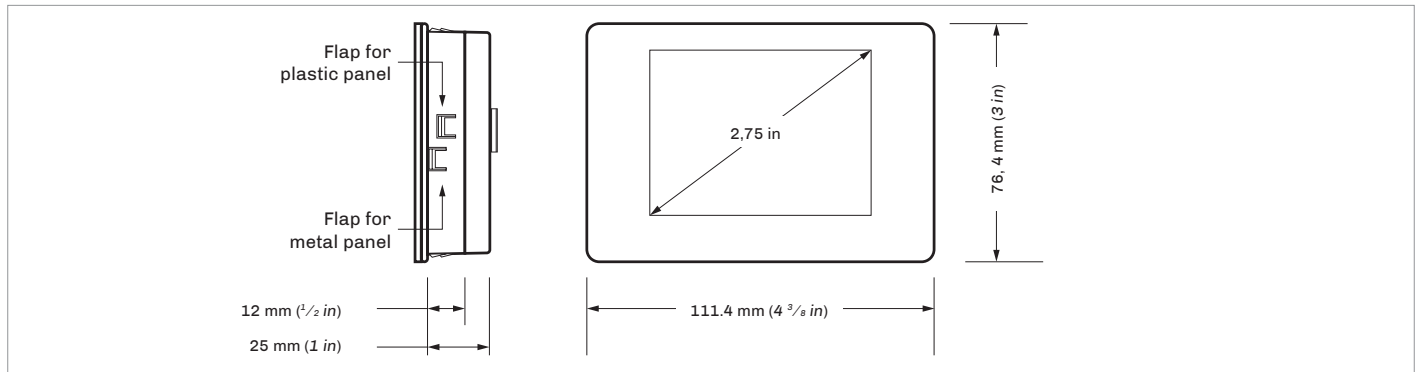

Models for wall mounting

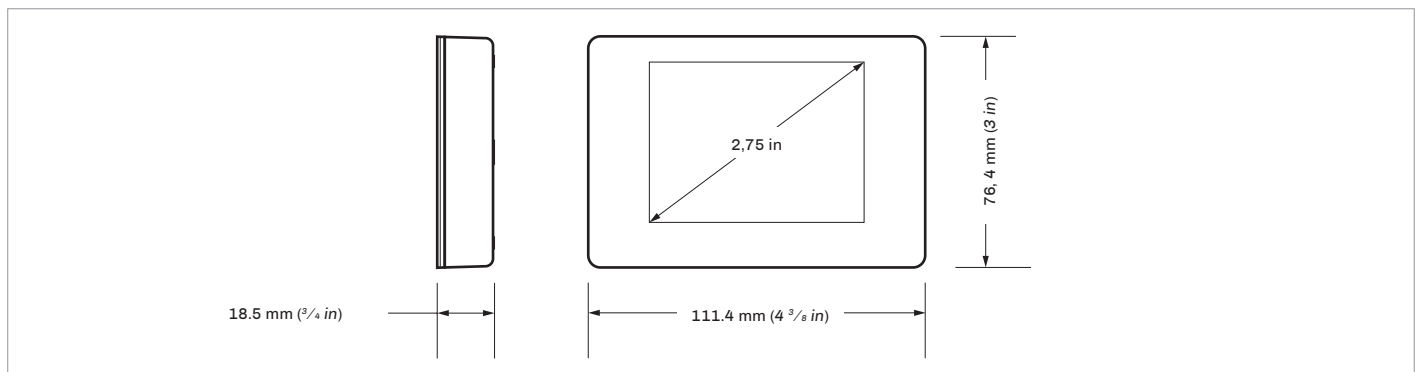

Installation

Models for panel mounting

To be fitted to a panel with elastic holding flaps

1. Make a hole of 107.6 mm ($3 \frac{15}{16}$ in) x 72.6 mm ($2 \frac{7}{8}$ in) with rounded corners R 3 mm ($\frac{1}{8}$ in)
2. Make the electrical connection without powering up the device
3. Fasten the device to the panel

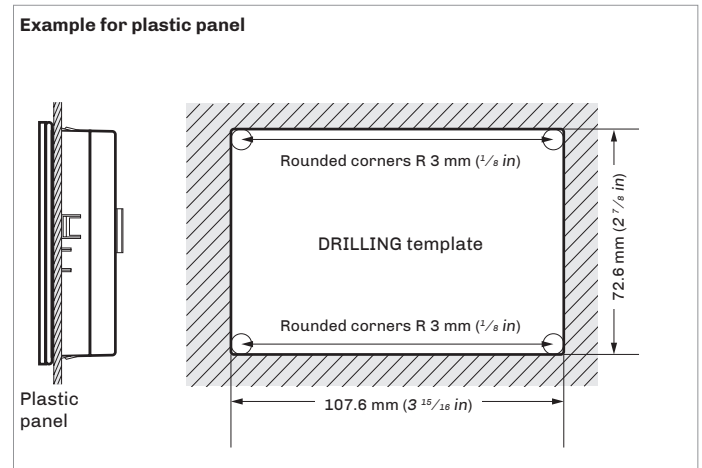

Models for wall mounting

A) Wall mounting

1. Unhook the back shell from the front through a screwdriver in the proper seat
2. Lean the back shell against the wall in a position suitable to get the connecting cable to pass through the proper opening
3. Use the slots of the back shell as template to drill 4 holes having a diameter suitable to the bolt 5.0 mm ($\frac{3}{16}$ in) diameter bolts are suggested
4. Insert the bolts in the holes drilled in the wall
5. Fasten the back shell at the wall with 4 screws
Countersunk head screws are suggested
6. Make the electrical connection without powering up the device
7. Fasten the front of the device at the back shell

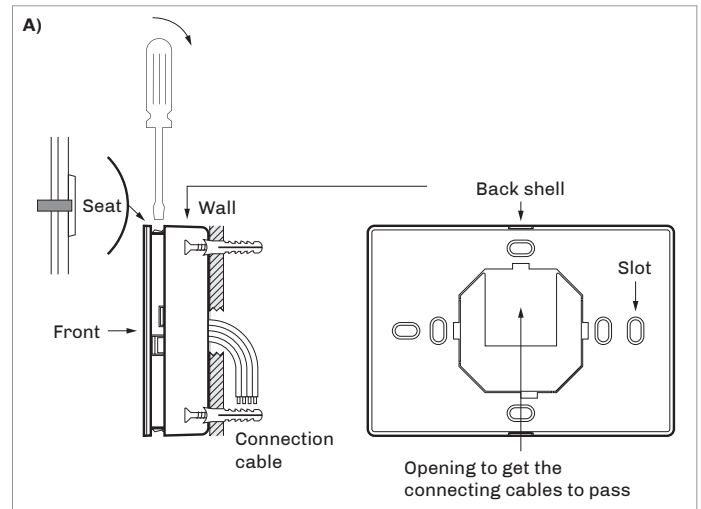

B) Flush mounting box

1. Unhook the back shell from the front through a screwdriver and the proper seat
2. Fasten the back shell at the box with 4 screws
Countersunk head screws are suggested
3. Make the electrical connection without powering up the device
4. Fasten the front of the device at the back shell

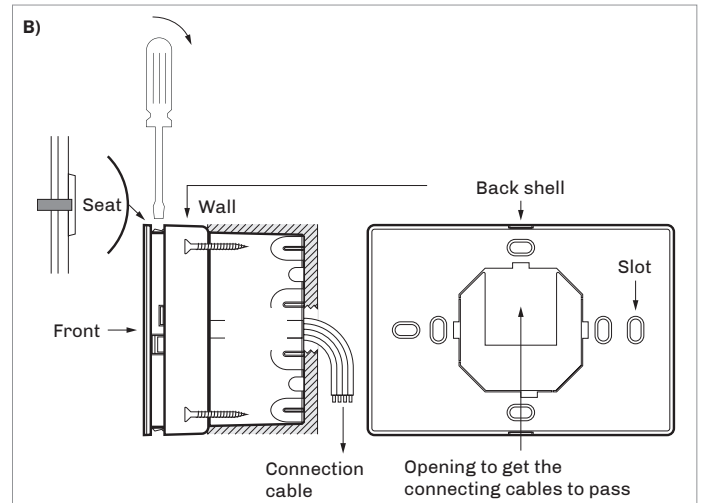

WARNINGS FOR INSTALLATION

- Ensure that the working conditions are within the limits
- Do not install the device close to heat sources, equipment with a strong magnetic field, in places subject to direct sunlight, rain, damp, excessive dust, mechanical vibrations or shocks
- In compliance with safety regulations, the device must be installed properly to ensure adequate protection from contact with electrical parts. All protective parts must be fixed in such a way as to need the aid of a tool to remove them

Electrical connections



WARNINGS FOR ELECTRICAL CONNECTIONS

- Use cables of an adequate section for the current running through them
- To reduce any electromagnetic interference connect the power cables as far away as possible from the signal cables and connect to a CAN and RS-485 MODBUS networks by using a twisted pair

Models for panel mounting

Connectors and parts

Connector 1

Number	Description
1	RS-485 MODBUS port reference
2	RS-485 MODBUS port reference -
3	RS-485 MODBUS port reference +

Connector 2

Number	Description
1	CAN port reference -
2	CAN port reference +
3	Device power supply (24 VAC/12... 30 VDC). If the device is fed by DC power, connect terminal minus
4	Device power supply (24 VAC/12... 30 VDC). If the device is fed by DC power, connect terminal plus

Connector 3

Number	Description
	USB port, for programming the device

Micro-switch

Number	Description
1	To terminate the RS-485 MODBUS network
2	To terminate the CAN network

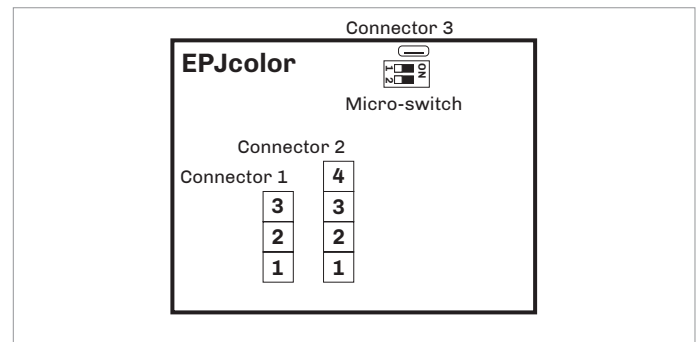

WARNINGS FOR ELECTRICAL CONNECTIONS

- If using an electrical or pneumatic screwdriver, adjust the tightening torque
- If the device has been moved from a cold to a warm place, the humidity may have caused condensation to form inside. Wait about an hour before switching on the power
- Make sure that the supply voltage, electrical frequency and power are within the set limits
- Disconnect the power supply before doing any type of maintenance
- Do not use the device as safety device
- For repairs and for further informations, contact the EVCO sales network; possible returns without label data will not be accepted

Electrical connection with independent power supply

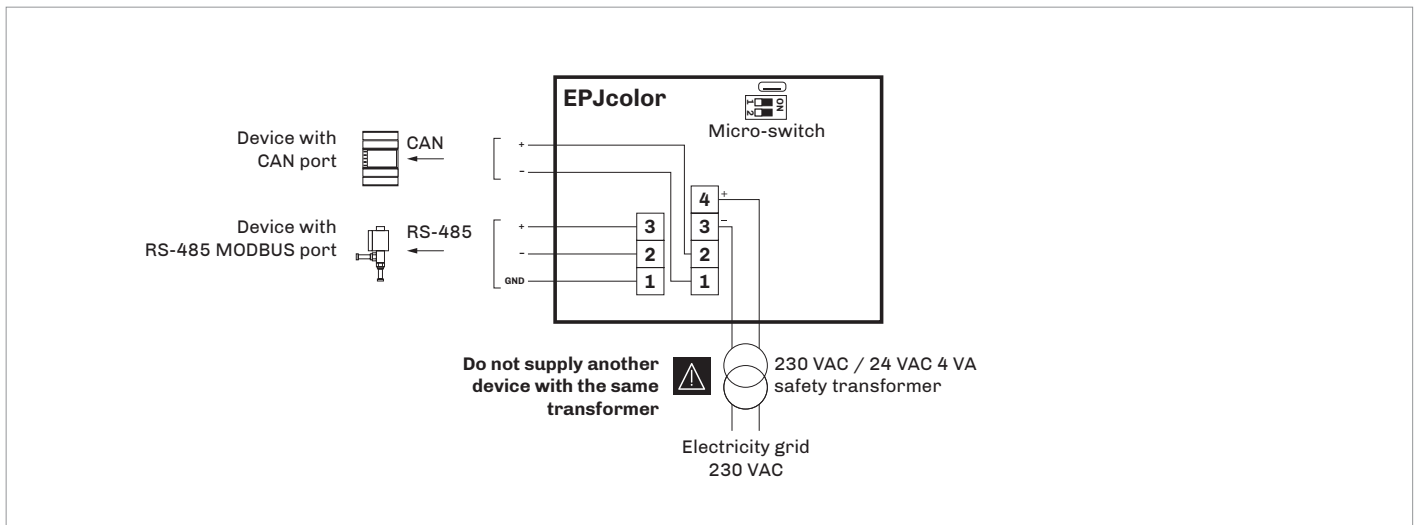

Electrical connection with device powered by a controller

Example: **c-pro 3 OEM**

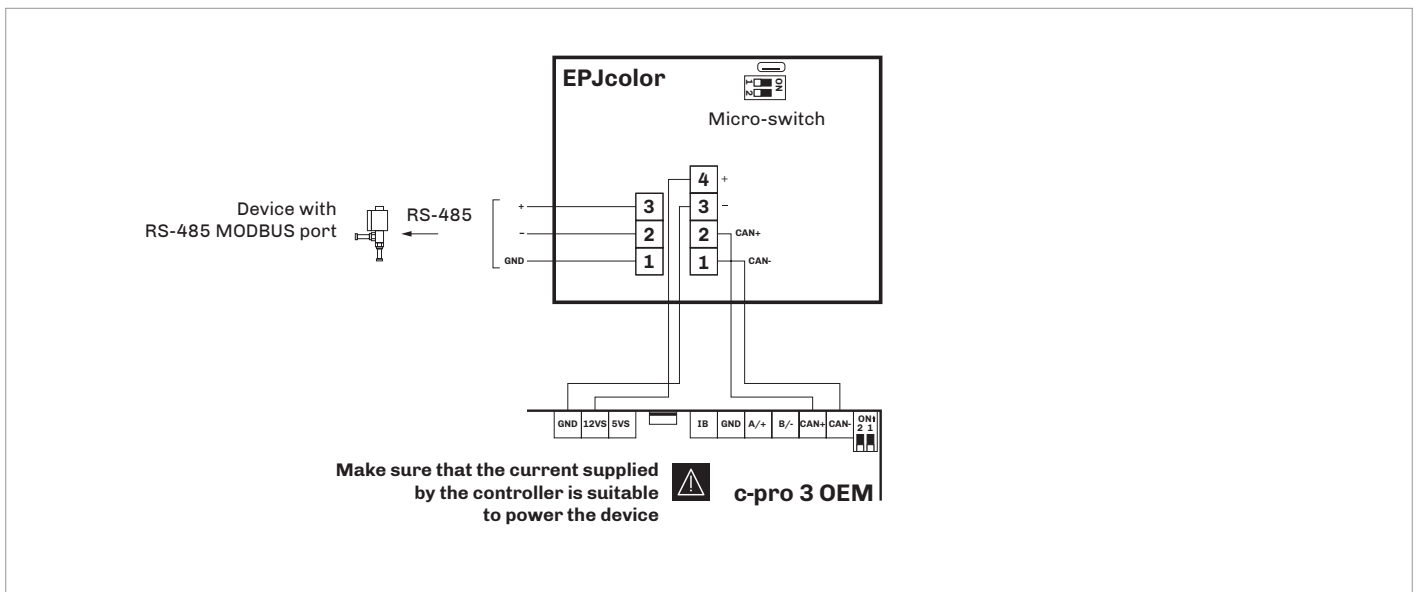

Termination of the RS-485 MODBUS and CAN network

To terminate the RS-485 MODBUS network:

- Place **micro-switch 2 in position ON**
- Let the **micro-switch 1 in position OFF (EVCO reserved)**

The micro-switch is on the back of the device (remove the back shell from the front before)



To terminate the CAN network:

- Place **micro-switch 2 in position ON**
- Let the **micro-switch 1 in position OFF (EVCO reserved)**



Models for wall mounting

Connectors and parts

Connector 1

Number	Description
1	CAN port reference -
2	CAN port reference +
3	Device power supply (24 VAC/12... 30 VDC). If the device is fed by DC power, connect terminal minus
4	Device power supply (24 VAC/12... 30 VDC). If the device is fed by DC power, connect terminal plus
5	RS-485 MODBUS port reference
6	RS-485 MODBUS port reference -
7	RS-485 MODBUS port reference +

Connector 2

Number	Description
	USB port, for programming the device

Micro-switch

Number	Description
1	To terminate the RS-485 MODBUS network
2	To terminate the CAN network

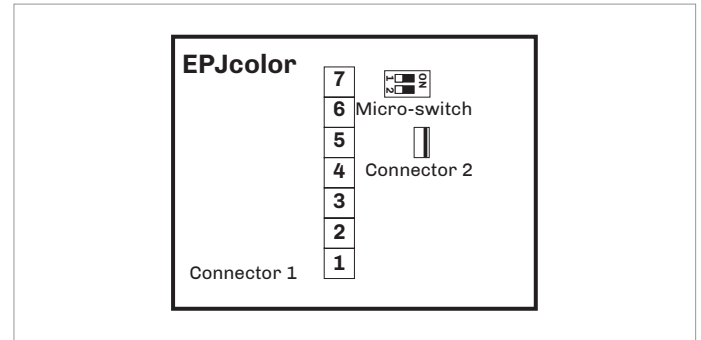

Electrical connection with independent power supply

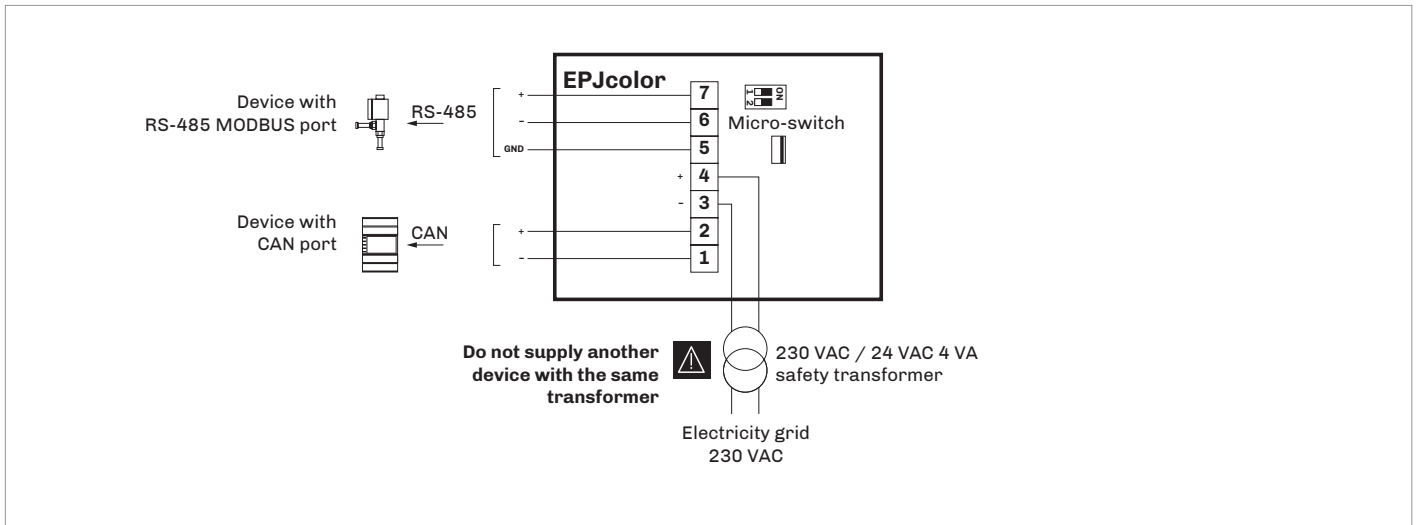

Electrical connection with device powered by a controller

Example: **c-pro 3 OEM**

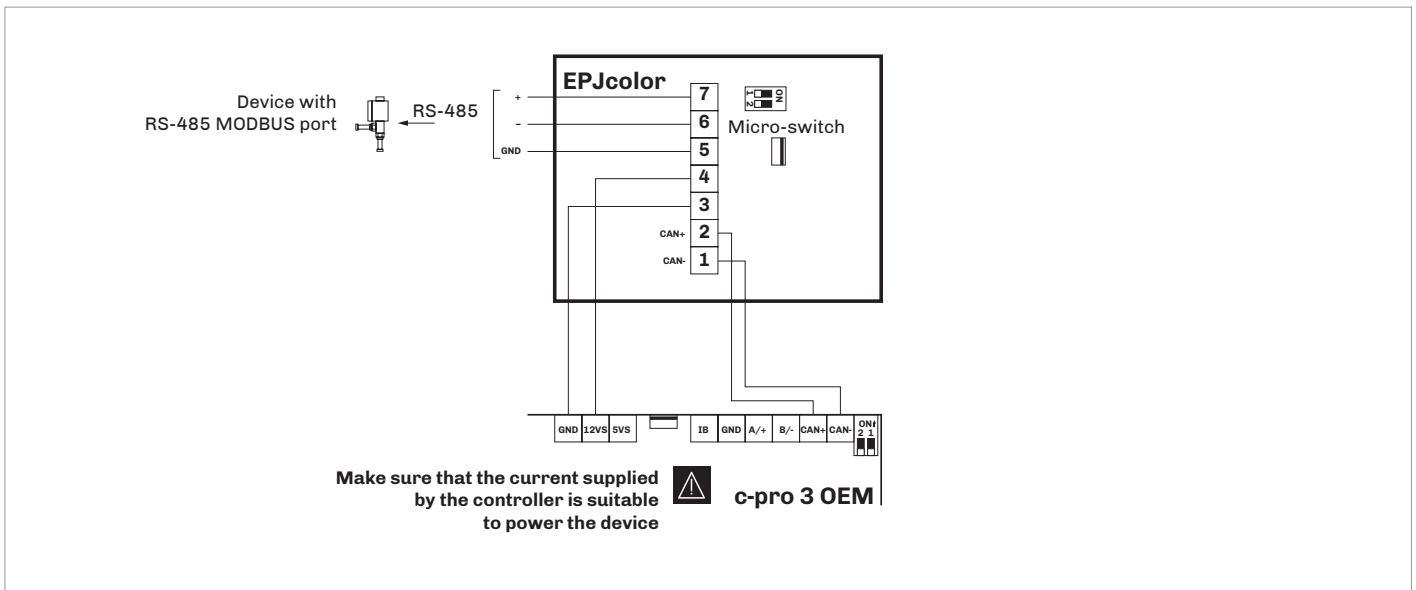

Termination of the RS-485 MODBUS and CAN network

To terminate the RS-485 MODBUS network:

- Place **micro-switch 2 in position ON**
- Let the **micro-switch 1 in position OFF (EVCO reserved)**

The micro-switch is on the back of the device (remove the back shell from the front before)









To terminate the CAN network:

- Place **micro-switch 2 in position ON**
- Let the **micro-switch 1 in position OFF (EVCO reserved)**



User interface

Sensitive areas description

Areas		Instructions
		HOME
ESC		ESCAPE
		LEFT AND RIGHT
		UP AND DOWN
		ENTER
		USER

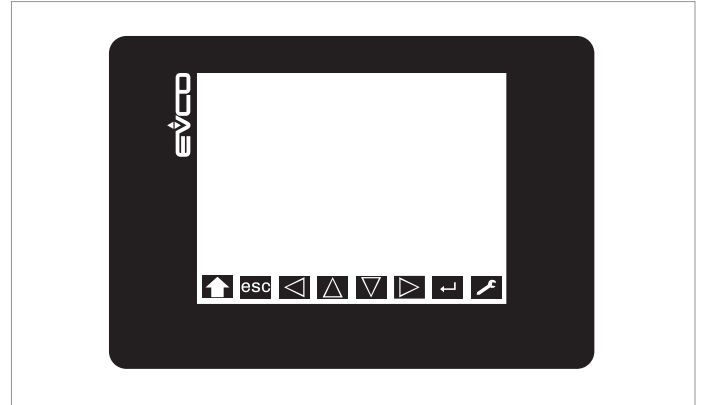

Switching ON/OFF the device

Progression	Description
1	Connect the power supply: it will be started an internal test that takes typically a few seconds
2	To the end of the internal test press and release the area in the bottom right-hand corner of the display: the display will show the sensitive areas
3	To switch OFF the device switch OFF the power supply



Menu settings

Sensitive areas description and parameters settings











WARNINGS

Turn off the power after changing the configuration









Sensitive areas

Touch the low part of the display to show the sensitive areas

"Info" menu

Areas	Instructions
	Touch the USER area: the display will show the "Network Status (CAN)" frame
	Touch the ENTER area: the display will show the "V-COLOR BROWS" frame
	Touch the ENTER area: the display will show the "Input Password" frame
	Touch the ENTER area
 	Touch the UP or DOWN area to set-up the password "-19"
 	Touch the UP or DOWN area to select the "Info" menu
	Touch the ENTER area
esc	Touch the ESCAPE area a few times to return to the previous displays

"Languages" menu

Areas	Instructions
	Touch the USER area: the display will show the "Network Status (CAN)" frame
	Touch the ENTER area: the display will show the "V-COLOR BROWS" frame
 	Touch the UP or DOWN area to select the "Languages" menu
	Touch the ENTER area
 	Touch the UP or DOWN area to select the language
	Touch the ENTER area
esc	Touch the ESCAPE area a few times to return to the previous displays

Parameters settings

"Info" menu











N.	Param.	Def.	"Info" menu	Min/max
1	PROJ	-	Project information	-
2	FW	-	Firmware information	-
3	HW	-	Hardware information	-
4	SW	-	Development environment information	-
5	SN	-	Serial number information and result of the productive test	-
6	DATE	-	Information on data and time last project compiling	-

"Languages" menu

N.	Param.	Def.	"Languages" menu	Min/max
7	English	-	Showing in English the project words (if foreseen)	-
8	Italian	-	Showing in Italian the project words (if foreseen)	-
9	Français	-	Showing in French the project words (if foreseen)	-
10	Español	-	Showing in Spanish the project words (if foreseen)	-
11	Deutsch	-	Showing in German the project words (if foreseen)	-
12	Russian	-	Showing in Russian the project words (if foreseen)	-
13	Português	-	Showing in Portuguese the project words (if foreseen)	-

Available if the application software of the connected control foresee the multilanguage management













“Parameters” menu

Areas	Instructions
	Touch the USER area: the display will show the “Network Status (CAN)” frame
	Touch the ENTER area: the display will show the “V-COLOR BROWS” frame
 	Touch the UP or DOWN area to select the “Parameters” menu
	Touch the ENTER area
 	Touch the UP or DOWN area to select a parameter
	Touch the ENTER area
 	Touch the UP or DOWN area to set-up the value
	Touch the ENTER area
ESC	Touch the ESCAPE area a few times to return to the previous displays

“Parameters” menu

N.	Param.	Def.	“Parameters” menu	Min/max
14	Date Char Separator	-	ASCII character as data separator	-
15	Year format	YY	Year format	YY=2 numbers YYYY=4 numbers
16	Date format	dd mm yy	Data format	yy mm dd= year, month, day mm dd yy= month, day, year dd mm yy= day, month, year
17	Time Char Separator	:	ASCII character as hour separator	-
18	Time With Sec	YES	Showing time with seconds	NO=no YES=yes
19	Time AM/PM	NO	Time format	NO=24 h YES=12 h
20	Backlight Mode	TIME	Backlight type	off=off on=on TIME=with Backlight Timeout
21	Backlight Timeout	60	Timeout backlight	0... 240 s
22	I/O Timeout	60	Delay remote I/O disabling from CAN communication absence	0... 240 s
23	Refresh Timeout	0	Update variables timeout	0... 100 ms
24	Print Loading	NO	Showing “Loading...” during project page loading	NO=no YES=yes
25	Password Timeout	60	“Parameters”, “Networks” and “Backup/Restore” menu password timeout	0... 240 s
26	Beep Mode	2	Beep type when touching the display	0=never 1=always 2=if the area is sensitive
27	Print Frame	0	Showing frames instead low size pages	0=no 1=yes



















“Networks -> CAN bus” menu

Areas	Instructions
	Touch the USER area: the display will show the “Network Status (CAN)” frame
	Touch the ENTER area: the display will show the “V-COLOR BROWS” frame
 	Touch the UP or DOWN area to select the “Networks” menu
	Touch the ENTER area
 	Touch the UP or DOWN area to select the “CAN bus” menu
 	Touch the UP or DOWN area to select the menu
	Touch the ENTER area
 	Touch the UP or DOWN area to set-up the value
	Touch the ENTER area
ESC	Touch the ESCAPE area a few times to return to the previous displays

“Networks -> CAN bus” menu

N.	Param.	Def.	“Networks > CAN bus” menu	Min/max
28	MyNode	99	Indirizzo CAN	1... 127
29	Master	-	Riservato	-
30	Baud	Auto	Baud rate CAN	20 K=20.000 baud 50 K=50.000 baud 125 K=125.000 baud 500 K=500.000 baud Auto= riconoscimento automatico baud rate se una delle precedenti
31	Timeout	5	Ritardo esclusione dispositivo in rete CAN da assenza comunicazione	0... 240 s
32	Network Node	-	Nodo fisico associato al nodo logico	[1] 1... [32] 127



















“Networks -> CAN bus -> CAN Status” menu

Areas	Instructions
	Touch the USER area: the display will show the “Network Status (CAN)” frame
	Touch the ENTER area: the display will show the “V-COLOR BROWS” frame
 	Touch the UP or DOWN area to select the “Networks” menu
	Touch the ENTER area
 	Touch the UP or DOWN area to select the “CAN bus” menu
	Touch the ENTER area
 	Touch the UP or DOWN area to select the “Network Node” menu
 	Touch the RIGHT area to select the “CAN Status” menu
 	Touch the UP or DOWN area to select the menu
	Touch the ENTER area
 	Touch the UP or DOWN area to set-up the value
	Touch the ENTER area
ESC	Touch the ESCAPE area a few times to return to the previous displays

“Networks -> CAN bus -> CAN Status” menu

N.	Param.	Def.	“Networks > CAN bus > CAN Status” menu	Min/max
33	Cnt Rx	-	Number of received packages	0... 9999
34	Cnt Tx	-	Number of transmitted packages	0... 9999
35	Cnt Ovf	-	Number of intercepted overflow	0... 9999
36	Cnt Passive	-	Number of intercepted passive	0... 9999
37	Cnt Bus Off	-	Number of intercepted bus off	0... 9999
38	BufRx Valid	-	Number receipts ok	0... 9999
39	BufTx Valid	-	Number of transmissions ok	0... 9999
40	Cnt Tx Err	-	Number of transmissions in error	0... 9999
41	Cnt Rx Err	-	Number of receipts in error	0... 9999
42	Cnt Stuff	-	Number stuff errors	0... 9999
43	Cnt Form	-	Number form errors	0... 9999
44	Cnt Ack	-	Number ack errors	0... 9999
45	Cnt Bit1	-	Number bit1 errors	0... 9999
46	Cnt Bit0	-	Number bit0 errors	0... 9999
47	Cnt CRC	-	Number CRC errors	0... 9999















“Networks -> CAN bus -> CAN Bit Timing” menu

Areas	Instructions
	Touch the USER area: the display will show the “Network Status (CAN)” frame
	Touch the ENTER area: the display will show the “V-COLOR BROWS” frame
 	Touch the UP or DOWN area to select the “Networks” menu
	Touch the ENTER area
 	Touch the UP or DOWN area to select the “CAN bus” menu
	Touch the ENTER area
 	Touch the UP or DOWN area to select the “Network Node” menu
 	Touch twice the RIGHT area to select the “CAN Bit Timing” frame
 	Touch the UP or DOWN area to select the menu
	Touch the ENTER area
 	Touch the UP or DOWN area to set-up the value
	Touch the ENTER area
ESC	Touch the ESCAPE area a few times to return to the previous displays

“Networks -> CAN bus -> CAN Bit Timing” menu

N.	Param.	Def.	“Networks > CAN bus > CAN Bit Timing” menu	Min/max
48	BrP	-	Reserved	-
49	SJW	-	Reserved	-
50	T.SEG1	-	Reserved	-
51	T.SEG1	-	Reserved	-









“Networks -> UART” menu

Areas	Instructions
	Touch the USER area: the display will show the “Network Status (CAN)” frame
	Touch the ENTER area: the display will show the “V-COLOR BROWS” frame
 	Touch the UP or DOWN area to select the “Networks” menu
	Touch the ENTER area
 	Touch the UP or DOWN area to select the “UART” menu
	Touch the ENTER area
 	Touch the UP or DOWN area to select the menu
	Touch the ENTER area
 	Touch the UP or DOWN area to set-up the value
	Touch the ENTER area
ESC	Touch the ESCAPE area a few times to return to the previous displays





“Networks -> UART” menu

N.	Param.	Def.	“Networks > UART” menu	Min/max
52	Address	1	MODBUS address	1... 247
53	Parity	even	MODBUS parity	none=none odd=odd even=even
54	Baudrate	9600	MODBUS baud rate	1200=1.200baud 2400=2.400baud 4800=4.800baud 9600=9.600baud 19200=19.200 baud 28800=28.800 baud 38400=38.400 baud 57600=57.600 baud
55	Bit Stop	1 bit	MODBUS stop bit	1 bit=1 bit 2 bit=2 bit





"Networks -> USB" menu

Areas		Instructions
		Touch the USER area: the display will show the "Network Status (CAN)" frame
		Touch the ENTER area: the display will show the "V-COLOR BROWS" frame
		Touch the UP or DOWN area to select the "Networks" menu
		Touch the ENTER area
		Touch the UP or DOWN area to select the "USB" menu
		Touch the ENTER area
esc		Touch the ESCAPE area a few times to return to the previous displays

"Diagnostic" menu

Areas		Instructions
		Touch the USER area: the display will show the "Network Status (CAN)" frame
		Touch the ENTER area: the display will show the "V-COLOR BROWS" frame
		Touch the UP or DOWN area to select the "Diagnostic" menu
		Touch the ENTER area
esc		Touch the ESCAPE area a few times to return to the previous displays

"Debug" menu

Areas		Instructions
		Touch the USER area: the display will show the "Network Status (CAN)" frame
		Touch the ENTER area: the display will show the "V-COLOR BROWS" frame
		Touch the UP or DOWN area to select the "Debug" menu
		Touch the ENTER area
esc		Touch the ESCAPE area a few times to return to the previous displays

"Networks -> USB" menu

N.	Param.	Def.	"Networks > USB" menu	Min/max
56	USB Status Init Device	-	Reserved	-
57	Device Status Idle Speed	-	Reserved	-

"Diagnostic" menu

N.	Param.	Def.	"Diagnostic" menu	Min/max
58	EEPROM	-	EEPROM memory status	OK=not in error ERR=in error
59	RTC	-	Clock status	OK=not in error ERR=in error LOW=data lost DISAB=not enabled
60	STACK	-	Stack status	OK=not in error ERR=in error (for overflow)
61	MATH	-	Math status	OK=not in error ERR=in error (for overflow, underflow, division by zero or NaN)
62	KEY PAR	-	Result upload/download via USB project and configuration parameters	OK=successfully completed ERR=unsuccessfully completed

"Debug" menu

N.	Param.	Def.	"Debug" menu	Min/max
63	Main time	-	Main cycle time for software (ms)	-
64	Max time main	-	Maximum value main cycle time for software	-
65	Free stack main	-	Minimum free stack of main	-
66	100ms time	-	Reserved	-
67	Max time 100 ms	-	Reserved	-
68	Free stack 100 ms	-	Reserved	-

Technical data

Type	Description	
Purpose of the control device	Function controller	
Construction of the control device	Built-in electronic device	
Container	Black, self-extinguishing	
Category of heat and fire resistance	D	
Dimensions	Models for panel mounting	- 111.4 x 76.4 x 25.0 mm (4 ³ / ₈ x 3 x 1 in)
	Models for wall mounting	- 111.4 x 76.4 x 18.5 mm (4 ³ / ₈ x 3 x ³ / ₄ in)
Mounting methods for the control device	According to the model: - Panel mounting - Wall mounting - In the most common flush mounting box	
Degree of protection provided by the covering	IP30 (IP65 in case of panel mounting)	
Connection method	- Models for panel mounting	Removable screw terminal blocks for wires up to 1 mm ²
	- Models for wall mounting	Fixed screw terminal blocks for wires up to 1 mm ²
Maximum permitted length for connection cables	Power supply: 10 m (32.8 ft)	
	RS-485 MODBUS port: 1,000 m (3.280 ft)	
	CAN port:	
	<ul style="list-style-type: none"> - 1,000 m (3.280 ft) with baud rate 20.000 baud - 500 m (1.640 ft) with baud rate 50.000 baud - 250 m (820 ft) with baud rate 125.000 baud - 50 m (164 ft) with baud rate 500.000 baud - Over 10 m (32.8 ft) use a shielded cable 	
Operating temperature	-10 – 55 °C (14 – 131 °F)	
Storage temperature	-20 – 70 °C (-4 – 158 °F)	
Operating humidity	Relative humidity from 5 to 95% non condensing	
Pollution status of the control device	2	
Compliance	- RoHS 2011/65/CE	
	- WEEE 2012/19/EU	
	- REACH (CE) regulation n. 1907/2006	
	- RED 2014/53/UE	
Power supply	24 VAC (±15%), 50/60 Hz (±3 Hz), max. 4 VA not insulated or 12... 30 VDC, max. 2 W not insulated (independent power supply or by a controller)	
Earthing methods for the control device	None	
Rated impulse-withstand voltage	I	
Over-voltage category	330 V	
Software class and structure	A	
Clock	Incorporated secondary lithium battery	
Clock drift	≤ 55 s/month at 25 °C (77 °F)	
Clock battery autonomy in the absence of a power supply	6 months	
Clock battery charging time	24 h (the battery is charged by the power supply of the device)	
Displays	Colour touch-screen TFT graphic display	
Alarm buzzer	Built-in	
Communications ports	- 1 RS-485 MODBUS port	
	- 1 CAN port	
	- 1 USB port	



EVCO S.p.A.

Via Feltre 81, 32036 Sedico (BL) ITALY

| Tel. +39 0437 8422

| Fax +39 0437 83648

| e-mail info@evco.it

| web www.evco.it

This document and the solutions contained therein are the intellectual property of EVCO and thus protected by the Italian Intellectual Property Rights Code (CPI). EVCO imposes an absolute ban on the full or partial reproduction and disclosure of the content other than with the express approval of EVCO. The customer (manufacturer, installer or end-user) assumes all responsibility for the configuration of the device. EVCO accepts no liability for any possible errors in this document and reserves the right to make any changes, at any time without prejudice to the essential functional and safety features of the equipment.